

INTERNATIONAL HYDROGRAPHIC ORGANIZATION



IHO UNIVERSAL HYDROGRAPHIC DATA MODEL

Special Publication No. 101
Electronic Navigational Chart Product Specification

Annex A
Data Classification and Encoding Guide

Version 0.0.2 – March 2017

Published by the
International Hydrographic Organization
4b quai Antoine 1^{er}
Principauté de Monaco
Tel: (377) 93.10.81.00
Fax: (377) 93.10.81.40
E-mail: info@iho.int
Web: www.iho.int

© Copyright International Hydrographic Organization 2017

This work is copyright. Apart from any use permitted in accordance with the Berne Convention for the Protection of Literary and Artistic Works (1886), and except in the circumstances described below, no part may be translated, reproduced by any process, adapted, communicated or commercially exploited without prior written permission from the International Hydrographic Organization (IHO). Copyright in some of the material in this publication may be owned by another party and permission for the translation and/or reproduction of that material must be obtained from the owner.

This document or partial material from this document may be translated, reproduced or distributed for general information, on no more than a cost recovery basis. Copies may not be sold or distributed for profit or gain without prior written agreement of the IHO Secretariat and any other copyright holders.

In the event that this document or partial material from this document is reproduced, translated or distributed under the terms described above, the following statements are to be included:

“Material from IHO publication [reference to extract: Title, Edition] is reproduced with the permission of the IHO Secretariat (Permission No/...) acting for the International Hydrographic Organization (IHO), which does not accept responsibility for the correctness of the material as reproduced: in case of doubt, the IHO’s authentic text shall prevail. The incorporation of material sourced from IHO shall not be construed as constituting an endorsement by IHO of this product.”

“This [document/publication] is a translation of IHO [document/publication] [name]. The IHO has not checked this translation and therefore takes no responsibility for its accuracy. In case of doubt the source version of [name] in [language] should be consulted.”

The IHO Logo or other identifiers shall not be used in any derived product without prior written permission from the IHO Secretariat.

CONTENTS

<i>CONTENTS</i>	<i>i</i>
1 OVERVIEW	1
1.1 PREFACE	1
1.2 S-101 ANNEX A; DATA CLASSIFICATION AND ENCODING GUIDE - METADATA	1
1.3 TERMS, DEFINITIONS AND ABBREVIATIONS	1
1.3.1 <i>Terms and definitions</i>	<i>1</i>
1.3.2 <i>Abbreviations</i>	<i>2</i>
1.4 USE OF LANGUAGE	3
1.5 MAINTENANCE	3
2 GENERAL	4
2.1 FEATURE TYPES	4
2.1.1 <i>Multiple features</i>	<i>4</i>
2.2 GEOMETRIC PRIMITIVES	5
2.2.1 <i>Capture density guideline</i>	<i>6</i>
2.3 INFORMATION TYPES	6
2.4 ATTRIBUTES	7
2.4.1 <i>Multiplicity</i>	<i>7</i>
2.4.2 <i>Simple attribute types</i>	<i>7</i>
2.4.3 <i>Mandatory and conditional attributes</i>	<i>8</i>
2.4.4 <i>Missing attribute values</i>	<i>11</i>
2.4.5 <i>Portrayal feature attributes</i>	<i>12</i>
2.4.6 <i>Textual information</i>	<i>12</i>
2.4.7 <i>Spatial attribute types</i>	<i>12</i>
2.4.8 <i>Dates</i>	<i>13</i>
2.4.8.1 <i>Seasonal features</i>	<i>13</i>
2.4.9 <i>Times</i>	<i>14</i>
2.4.9.1 <i>Schedules</i>	<i>14</i>
2.4.10 <i>Colours and colour patterns</i>	<i>14</i>
2.4.11 <i>Radar conspicuous features (see S-4 – B-485.2)</i>	<i>15</i>
2.4.12 <i>Attributes referencing external files</i>	<i>15</i>
2.4.12.1 <i>Reference to textual files</i>	<i>15</i>
2.4.12.2 <i>Reference to pictorial files</i>	<i>15</i>
2.5 DATASETS	16
2.5.1 <i>ENC data coverage</i>	<i>16</i>
2.5.2 <i>Discovery metadata</i>	<i>17</i>
2.5.3 <i>Minimal depiction areas</i>	<i>17</i>
2.5.3.1 <i>Wide blank areas</i>	<i>17</i>
2.5.3.2 <i>Simplified or minimum depiction areas</i>	<i>17</i>
2.5.4 <i>Dataset attributes</i>	<i>18</i>
2.5.5 <i>Units</i>	<i>18</i>
2.5.6 <i>Coordinate multiplication factor</i>	<i>18</i>
2.5.7 <i>Seamless ENC coverage</i>	<i>18</i>
2.5.8 <i>Feature Object Identifiers</i>	<i>20</i>
2.5.9 <i>180° Meridian of Longitude</i>	<i>20</i>
2.5.10 <i>Heights and elevations</i>	<i>20</i>
2.5.11 <i>Geographic names</i>	<i>21</i>
2.5.11.1 <i>Text placement</i>	<i>22</i>
2.5.12 <i>Sample scale minimum policy</i>	<i>22</i>
2.5.13 <i>Masking</i>	<i>30</i>
2.6 DESCRIPTION OF TABLE FORMAT FOR S-101 META AND GEO FEATURES	35
3 METADATA FEATURES	37
3.1 HORIZONTAL UNCERTAINTY	37
3.2 VERTICAL UNCERTAINTY	37
3.3 QUALITY OF NON-BATHYMETRIC DATA	38
3.3.1 <i>Quality of non-bathymetric data</i>	<i>38</i>
3.4 DATA COVERAGE	39

3.4.1	Coverage.....	39
3.5	NAVIGATIONAL SYSTEM OF MARKS	41
3.5.1	<i>Buoyage systems (see S-4 – B-461)</i>	41
3.6	LOCAL DIRECTION OF BUOYAGE.....	42
3.6.1	<i>Local direction of buoyage (see S-4 – B-461.5)</i>	42
3.7	QUALITY OF BATHYMETRIC DATA	43
3.7.1	<i>Quality, reliability and accuracy of bathymetric data (see S-4 – B-297)</i>	43
3.7.1.1	Feature detection	45
3.7.1.2	Temporal variation	46
3.7.1.3	Sounding uncertainty.....	46
3.8	SOUNDING DATUM.....	47
3.8.1	<i>Sounding datum</i>	48
3.9	VERTICAL DATUM.....	49
3.9.1	<i>Vertical datum</i>	49
3.10	QUALITY OF SURVEY	51
3.10.1	<i>Survey reliability and source of bathymetric data</i>	52
3.10.2	<i>Quality of sounding</i>	52
3.10.3	<i>Technique of vertical measurement</i>	53
3.11	UPDATE INFORMATION	54
3.11.1	<i>Update information</i>	54
4	GEO FEATURES – MAGNETIC DATA	55
4.1	MAGNETIC VARIATION.....	55
4.1.1	<i>Magnetic variation (see S-4 – B-261; B-270 to B-273)</i>	55
4.2	LOCAL MAGNETIC ANOMALY.....	56
4.2.1	<i>Local magnetic anomaly (see S-4 – B-274)</i>	56
5	GEO FEATURES – NATURAL FEATURES.....	57
5.1	CLIFFS (SEE S-4 – B-312.3)	57
5.2	CUTTINGS AND EMBANKMENTS (SEE S-4 – B-363.2 AND B-364.1)	58
5.3	COASTLINE.....	59
5.3.1	<i>Coastline (see S-4 – B-310 and B-311)</i>	59
5.3.2	<i>Natural coastline (see S-4 – B-312 and B-353.8)</i>	60
5.4	LAND AREA.....	61
5.4.1	<i>Land area</i>	61
5.4.2	<i>Rocks which do not cover (islets) (see S-4 – B-421.1)</i>	61
5.5	ISLAND GROUP.....	63
5.5.1	<i>Island groups</i>	63
5.6	LAND ELEVATION	64
5.6.1	<i>Height contours, spot heights (see S-4 – B-351 and B-352.1-2)</i>	64
5.7	RIVER.....	66
5.7.1	<i>Rivers (see S-4 – B-353)</i>	66
5.8	RAPIDS.....	68
5.8.1	<i>Rapids (see S-4 – B-353.5)</i>	68
5.9	WATERFALL	69
5.9.1	<i>Waterfalls (see S-4 – B-353.5)</i>	69
5.10	LAKE.....	70
5.10.1	<i>Lakes (see S-4 – B-353.6)</i>	70
5.11	LAND REGION	71
5.11.1	<i>Natural sceneries (see S-4 – B-350)</i>	72
5.11.1.1	Marsh (see S-4 – B-312.2).....	72
5.11.1.2	Salt pans (see S-4 – B-353.7).....	72
5.11.1.3	Lava flow (see S-4 – B-355).....	72
5.12	VEGETATION.....	73
5.12.1	<i>Vegetation (see S-4 – B-312.4; B-352.4 and B-354)</i>	73
5.13	ICE AREA	75
5.13.1	<i>Ice areas (see S-4 – B-353.8 and B-449.1)</i>	75
5.13.1.1	Glaciers (see S-4 – B-353.8).....	75
5.14	SLOPING GROUND.....	77
5.14.1	<i>Sloping ground (see S-4 – B-312.1; B-312.3; B-363.2 and B-364.1)</i>	77
5.14.1.1	Dunes, sand hills (see S-4 – B-312.3).....	78

5.15	SLOPE TOPLINE	79
5.15.1	<i>Slope topline (see S-4 – B-312.1; B-363.2 and B-364.1)</i>	79
5.16	TIDEWAY	80
5.16.1	<i>Tideways (see S-4 – B-413.3)</i>	80
6	GEO FEATURES – CULTURAL FEATURES	81
6.1	BUILT-UP AREA	81
6.1.1	<i>Built-up areas (see S-4 – B-370.3-4 and B-370.6-7)</i>	81
6.2	BUILDING, SINGLE	83
6.2.1	<i>Buildings (see S-4 – B-325; B-328.1; B-362.2; B-370.3; B-370.5; B-372 and B-373.1-4)</i> 85	
6.2.2	<i>Harbour offices (see S-4 – B-325)</i>	86
6.2.3	<i>Transit sheds and warehouses (see S-4 – B-328.1)</i>	86
6.3	AIRPORT/AIRFIELD	88
6.3.1	<i>Airfields (see S-4 – B-366)</i>	88
6.4	RUNWAY	90
6.4.1	<i>Airfields (see S-4 – B-366)</i>	90
6.5	BRIDGE	92
6.5.1	<i>Bridges (see S4 – B-381)</i>	93
6.5.2	<i>Examples of Encoding Common Bridge Types</i>	94
6.6	SPAN FIXED	96
6.6.1	<i>Span fixed</i>	96
6.7	SPAN OPENING	98
6.7.1	<i>Span opening</i>	99
6.8	CONVEYOR	100
6.8.1	<i>Conveyors (see S-4 – B-382.3)</i>	101
6.9	OVERHEAD CABLES	103
6.9.1	<i>Overhead cables (see S-4 – B-382)</i>	104
6.10	PIPELINE, OVERHEAD	106
6.10.1	<i>Overhead pipelines (see S-4 – B-383)</i>	107
6.11	PYLON/BRIDGE SUPPORT	109
6.11.1	<i>Pylons and bridge supports (see S-4 – B-381.5 and B-382.1)</i>	110
6.12	FENCE/WALL	112
6.12.1	<i>Fences and walls</i>	113
6.13	RAILWAY	114
6.13.1	<i>Railways (see S-4 – B-328.4 and B-362)</i>	114
6.14	ROAD	115
6.14.1	<i>Roads and tracks (see S-4 – B-365)</i>	115
6.15	TUNNEL	117
6.15.1	<i>Tunnels (see S-4 – B-363.1)</i>	118
7	GEO FEATURES – LANDMARKS	119
7.1	BUILDINGS, LANDMARKS, TANKS, SILOS: COMMON ENCODING COMBINATIONS	119
7.2	LANDMARK	122
7.2.1	<i>Buildings, landmarks, tanks, silos (see S-4 – B-373; B-373.6; B-374.3-5; B-374.7; B-375.1-2; B-456.2; B-487.3)</i>	124
7.3	SILO/TANK	126
7.3.1	<i>Tanks, silos (see S-4 – B-340.2 and B-376)</i>	127
7.4	WIND TURBINE	129
7.4.1	<i>Wind turbines (see S-4 – B-374.6; B-445.8-9)</i>	130
7.5	FORTIFIED STRUCTURE	132
7.5.1	<i>Fortified structures (see S-4 – B-379)</i>	133
7.6	PRODUCTION/STORAGE AREA	134
7.6.1	<i>Production and storage areas (see S-4 – B-328.2; 367; 374.6)</i>	135
8	GEO FEATURES – PORTS	136
8.1	WORKS IN PROGRESS AND PROJECTED (SEE S-4 – B-329)	136
8.1.1	<i>Works on land (see S-4 – B-329.1)</i>	136
8.1.2	<i>Works at sea (see S-4 – B-329.2-5)</i>	136
8.2	CHECKPOINT	137

8.2.1	Checkpoints	137
8.3	HULKS.....	138
8.3.1	Hulks (see S-4 – B-330).....	139
8.4	PILES	140
8.4.1	Piles (see S-4 – B-327.3).....	141
8.5	DYKE	143
8.5.1	Dykes (see S-4 – B-313.1)	143
8.6	SHORELINE CONSTRUCTION	145
8.6.1	Coastline.....	146
8.6.2	Artificial coastline (see S-4 – B-313; B-320-322; B-324 and B-329).....	147
8.7	CAUSEWAY.....	149
8.7.1	Causeways (see S-4 – B-313.3).....	149
8.8	CANAL	151
8.8.1	Canals (see S-4 – B-361)	151
8.9	DISTANCE MARK	153
8.9.1	Distance marks (see S-4 – B-307 and B-361.3).....	153
8.10	GATE	155
8.10.1	Gates (see S-4 – B-326.5-7).....	156
8.11	DAM.....	157
8.11.1	Dams (see S-4 – B-364.2)	158
8.11.2	Flood barrages (see S-4 – B-326.7).....	158
8.12	CRANE	159
8.12.1	Cranes (see S-4 – B-328.3).....	160
8.13	BERTH.....	162
8.13.1	Berths (see S-4 – B-321; B-321.6-8).....	162
8.14	MOORING/WARPING FACILITY	164
8.14.1	Mooring / warping facilities (see S-4 – B-327.1-4; B-431.5-6).....	165
8.14.1.1	Mooring buoys (see S-4 – B-431.5).....	166
8.14.1.2	Mooring trots (see S-4 – B-431.6).....	166
8.15	DRY DOCK.....	168
8.15.1	Dry docks (see S-4 – B-326.1).....	169
8.16	FLOATING DOCK	170
8.16.1	Floating docks (see S-4 – B-326.2).....	171
8.17	PONTOON.....	172
8.17.1	Pontoons (see S-4 – B-324.3).....	172
8.18	DOCK AREA.....	174
8.18.1	Tidal and non-tidal basins (see S-4 – B-326.3-4).....	174
8.19	GRIDIRON	176
8.19.1	Gridirons (see S-4 – B-326.8).....	176
8.20	LOCKS	177
8.20.1	Locks (see S-4 – B-326.6).....	177
9	GEO FEATURES – TOPOGRAPHIC TERMS	179
9.1	SEA AREA/NAMED WATER AREA	179
9.1.1	Sea areas (see S-4 – B-550).....	180
10	GEO FEATURES – TIDES, CURRENTS.....	181
10.1	TIDAL DATA (SEE S-4 – B-406 TO B-408).....	181
10.2	TIDAL STREAM – FLOOD/EBB	182
10.2.1	Tidal stream (flood/ebb) (see S-4 – B-407 and B-407.4)	182
10.3	CURRENT – NON-GRAVITATIONAL	184
10.3.1	Current data (see S-4 – B-408).....	184
10.4	WATER TURBULENCE	186
10.4.1	Overfalls, races, breakers, eddies (see S-4 – B-423).....	186
10.5	TIDAL STREAM PANEL DATA.....	187
10.5.1	Tidal stream panels (see S-4 – B-407 and B-407.2-3).....	187
11	GEO FEATURES – DEPTHS.....	190
11.1	GENERALISATION OF DEPTH PORTRAYAL	190
11.2	REPRESENTATION OF DEPTH: GENERAL.....	190

11.3	SOUNDING	191
11.3.1	<i>Soundings (see S-4 – B-412 and B-413.1)</i>	192
11.4	DREDGED AREA	193
11.4.1	<i>Dredged areas (see S-4 – B-414)</i>	194
11.5	SWEPT AREA	195
11.5.1	<i>Swept areas (see S-4 – B-415)</i>	195
11.6	DEPTH CONTOUR	197
11.6.1	<i>Depth contours (see S-4 – B-404.2; B-410; B-411 to B-411.5; B-413 and B-413.1)</i>	197
11.7	DEPTH AREA	199
11.7.1	<i>Depth areas (see S-4 – B-410)</i>	199
11.7.2	<i>Geometry of depth areas</i>	199
11.7.3	<i>Use of attributes depth range minimum value and depth range maximum value for depth areas in general</i>	200
11.7.4	<i>Rivers, canals, lakes, basins, locks</i>	201
11.7.5	<i>Areas of continual change (see S-4 – B-416)</i>	201
11.8	DEPTH – NO BOTTOM FOUND	202
11.8.1	<i>No bottom found depths (see S-4 – B-412.3)</i>	202
11.9	AREAS WITH INADEQUATE DEPTH INFORMATION	203
11.9.1	<i>Inadequately surveyed areas (see S-4 – B-417)</i>	203
11.9.2	<i>Bathymetry in areas of minimal depiction of detail on paper charts</i>	203
11.9.2.1	<i>Areas of omitted bathymetry</i>	203
11.9.2.2	<i>Areas of very simplified bathymetry</i>	203
11.9.3	<i>Depth discontinuities between surveys (see S-4 – B-416.1)</i>	204
11.9.4	<i>Satellite imagery as source information</i>	204
11.10	UNSURVEYED AREA	205
11.10.1	<i>Unsurveyed areas (see S-4 – B-418)</i>	205
12	GEO FEATURES – NATURE OF THE SEABED	206
12.1	SEABED AREA	206
12.1.1	<i>Description of the seabed (see S-4 – B-425 to B-427)</i>	207
12.2	WEED/KELP	209
12.2.1	<i>Weed - Kelp (see S-4 – B-428.2)</i>	209
12.3	SANDWAVES	210
12.3.1	<i>Sandwaves (see S-4 – B-428.1)</i>	210
12.4	SPRINGS IN THE SEABED	211
12.4.1	<i>Springs in the seabed (see S-4 – B-428.3)</i>	211
13	GEO FEATURES – ROCKS, WRECKS, FOUL GROUND, OBSTRUCTIONS	212
13.1	DANGER LINE LIMITING AN AREA OF WRECKS OR OBSTRUCTIONS	212
13.2	DANGER LINE BORDERING AN AREA THROUGH WHICH NAVIGATION IS NOT SAFE (SEE S-4 – B-420.1)	212
13.3	DOUBTFUL DANGERS (SEE S-4 – B-424)	212
13.4	ROCKS (INTERTIDAL/AWASH/SUBMERGED)	214
13.4.1	<i>Rocks which may cover (see S-4 – B-421.2 to B-421.4)</i>	215
13.5	WRECKS	217
13.5.1	<i>Wrecks (see S-4 – B-422, B-422.1 to B-422.8)</i>	218
13.5.1.1	<i>Where a wreck is shown with its true shape (large scale ENCs) (see S-4 – B-422.1)</i>	219
13.5.1.2	<i>Changing criteria for wrecks</i>	220
13.5.2	<i>Historic wrecks (see S-4 – B-449.5)</i>	220
13.6	OBSTRUCTIONS	221
13.6.1	<i>Obstructions and foul areas (see S-4 – B-327.5, B-420.1, B-422.8-9, B-431.6, B-445.1 and B-447.5, B-447.7)</i>	223
13.7	FOUL GROUND	225
13.7.1	<i>Foul ground (see S-4 – B-422.8)</i>	226
13.8	DISCOLOURED WATER	227
13.8.1	<i>Discoloured water (see S-4 – B-424.6)</i>	227
13.9	FISHING FACILITY	228
13.9.1	<i>Fishing facilities (see S-4 – B-447 and B-447.1-3)</i>	228
13.10	MARINE FARM/CULTURE	230
13.10.1	<i>Marine farms (see S-4 – B-447.4 and B-447.6)</i>	231

13.10.2	<i>Fish havens (see S-4 – B- 447.5)</i>	232
14	GEO FEATURES – OFFSHORE INSTALLATIONS	233
14.1	OFFSHORE PLATFORM	233
14.1.1	<i>Offshore platforms (see S-4 – B-445.2; B-445.4 and B-445.5)</i>	234
14.1.2	<i>Wellheads (see S-4 – B-445.1)</i>	235
14.1.3	<i>Offshore safety zones (see S-4 – B-445.6)</i>	235
14.1.4	<i>Offshore flare stacks (see S-4 – B-445.2)</i>	235
14.2	SUBMARINE CABLES	237
14.2.1	<i>Submarine cables (see S-4 – B-443; B-443.1-2 and B-443.7-8)</i>	237
14.3	SUBMARINE CABLE AREA	239
14.3.1	<i>Submarine cable areas (see S-4 – B-439.3 and B-443.3)</i>	240
14.4	SUBMARINE/LAND PIPELINES	241
14.4.1	<i>Pipelines, submarine or on land (see S-4 – B-377; B-444; B-444.1-2; B-444.4-5 and B-444.7)</i> 242	
14.4.2	<i>Diffusers, cribs</i>	242
14.5	SUBMARINE PIPELINE AREA	244
14.5.1	<i>Submarine pipeline areas (see S-4 – B-439.3 and B-444.3)</i>	245
14.6	OFFSHORE PRODUCTION AREA	246
14.6.1	<i>Offshore production areas (see S-4 – B-445.3; B-445.7; B-445.9; B-445.11 and B-445.12)</i> 247	
14.6.2	<i>Offshore tanker loading systems (see S-4 – B-445.4)</i>	248
15	GEO FEATURES – TRACKS AND ROUTES	249
15.1	LEADING, CLEARING AND TRANSIT LINES AND RECOMMENDED TRACKS (SEE S-4 – B-433 AND B-434) 249	
15.1.1	<i>Range systems - relationship</i>	249
15.2	TRAFFIC LANES	249
15.3	TRAFFIC SEPARATION SCHEMES AND TRAFFIC SEPARATION SCHEME SYSTEMS (SEE S-4 – B-435.1-3)	250
15.4	NAVIGATION LINE	252
15.4.1	<i>Navigation lines (see S-4 – B-433)</i>	252
15.4.2	<i>Measured distances (see S-4 – B-458)</i>	253
15.5	RECOMMENDED TRACK	255
15.5.1	<i>Recommended tracks (see S-4 – B-432.1; B-434 and B-434.1-4)</i>	256
15.6	RANGE SYSTEM	258
15.6.1	<i>Range systems (see S4 – B-433)</i>	258
15.7	FAIRWAYS	260
15.7.1	<i>Fairways (see S-4 – B-432.1(c) and B-434.5)</i>	261
15.8	FAIRWAY SYSTEMS	263
15.8.1	<i>Fairway systems (see S-4 – B-432.1(c) and B-434.5)</i>	263
15.9	RECOMMENDED ROUTES	265
15.9.1	<i>Recommended routes (see S-4 – B-435.4)</i>	266
15.10	TWO-WAY ROUTE PART	267
15.10.1	<i>Two-way Routes (see S-4 – B-435.6)</i>	268
15.11	TWO-WAY ROUTE	270
15.11.1	<i>Two-way routes (see S4 – B-435.6)</i>	270
15.12	RECOMMENDED TRAFFIC LANE PART	272
15.12.1	<i>Recommended traffic lane part (see S-4 – B-435.5)</i>	272
15.13	DEEP WATER ROUTE CENTRELINE	273
15.13.1	<i>Deep Water routes centrelines (see S-4 – B-435.3)</i>	274
15.14	DEEP WATER ROUTE PART	276
15.14.1	<i>Deep Water route parts (see S-4 – B-435; B-435.3 and B-436.3)</i>	277
15.15	DEEP WATER ROUTE	279
15.15.1	<i>Deep Water routes (see S4 – B-435.3)</i>	279
15.16	INSHORE TRAFFIC ZONE	281
15.16.1	<i>Inshore traffic zones (see S-4 – B-435.1)</i>	282
15.17	PRECAUTIONARY AREA	283
15.17.1	<i>Precautionary areas (see S-4 – B-435.2)</i>	284
15.18	TRAFFIC SEPARATION SCHEME LANE PART	285

15.18.1	Traffic separation scheme lanes (see S-4 – B-435.1)	286
15.19	TRAFFIC SEPARATION ZONE	287
15.19.1	Traffic separation zones (see S-4 – B-435.1 and B-436.3)	287
15.20	TRAFFIC SEPARATION LINE	288
15.20.1	Traffic separation line (see S-4 – B-435.1 and B-436.3)	288
15.21	TRAFFIC SEPARATION SCHEME BOUNDARY	289
15.21.1	Traffic separation scheme boundaries (see S-4 – B-435.1)	289
15.22	TRAFFIC SEPARATION SCHEME CROSSING	290
15.22.1	Traffic separation scheme crossing (see S-4 – B-435.1)	290
15.23	TRAFFIC SEPARATION SCHEME ROUNDABOUT	292
15.23.1	Traffic separation scheme roundabout (see S-4 – B-435.1)	292
15.24	TRAFFIC SEPARATION SCHEME	294
15.24.1	Traffic separation schemes (see S4 – B-435.1-3)	294
15.25	ARCHIPELAGIC SEA LANE AREA	296
15.25.1	Archipelagic Sea Lane area (see S-4 – B-435.10)	296
15.26	ARCHIPELAGIC SEA LANE AXIS	298
15.26.1	Archipelagic Sea Lane Axis (see S-4 – B-435.10)	298
15.27	ARCHIPELAGIC SEA LANE	300
15.27.1	Archipelagic Sea Lanes (see S4 – B-435.10)	300
15.28	RADIO CALLING-IN POINT	302
15.28.1	Radio calling-in (reporting) points (see S-4 – B-488.1 and B-488.2)	302
15.29	FERRY ROUTE	304
15.29.1	Ferries (see S-4 – B-438)	304
15.30	RADAR LINE	306
15.30.1	Radar reference lines (see S-4 – B-487.2)	306
15.31	RADAR RANGE	307
15.31.1	Radar ranges (see S-4 – B-487.1)	307
15.32	RADAR STATION	308
15.32.1	Radar station (see S-4 – B-485.1 and B-487.3)	308
16	GEO FEATURES – AREAS, LIMITS	310
16.1	INTERNATIONAL BOUNDARIES AND NATIONAL LIMITS (SEE S-4 – B-440)	310
16.2	MARITIME JURISDICTION AREAS	310
16.2.1	Maritime jurisdiction areas in dispute	311
16.3	ANCHORAGE AREA	312
16.3.1	Anchorage (see S-4 – B-431.1; B-431.3 and B-431.7)	313
16.4	ANCHOR BERTH	314
16.4.1	Anchor berths (see S-4 – B-431.2)	315
16.5	SEAPLANE LANDING AREA	316
16.5.1	Seaplane landing areas (see S-4 – B-449.6)	317
16.6	DUMPING GROUND	318
16.6.1	Dumping grounds (see S-4 – B-442; B-446 and B-446.1)	319
16.6.2	Spoil grounds, dredging areas (see S-4 – B-446)	319
16.7	MILITARY PRACTICE AREA	320
16.7.1	Military practice areas (see S-4 – B-441.1-6)	321
16.8	ADMINISTRATION AREA	322
16.8.1	International and national territories (see S-4 – B-440.1 and B-440.3)	322
16.9	CARGO TRANSHIPMENT AREA	323
16.9.1	Cargo transshipment areas (see S-4 – B-449.4)	324
16.10	CAUTION AREA	325
16.10.1	Caution areas (see S-4 – B-242)	325
16.11	INFORMATION AREA	327
16.11.1	Information areas (see S-4 – B-XXX)	327
16.12	CONTIGUOUS ZONE	329
16.12.1	Contiguous Zones (see S-4 – B-440.6)	329
16.13	CONTINENTAL SHELF AREA	330
16.13.1	Continental Shelf (see S-4 – B-440.8)	330
16.14	CUSTOM ZONE	331
16.14.1	Custom Zones (see S-4 – B-440.2)	331
16.15	EXCLUSIVE ECONOMIC ZONE	332

16.15.1	Exclusive Economic Zones (see S-4 – B-440.9).....	332
16.16	FISHERY ZONE	333
16.16.1	Fishery zones (see S-4 – B-440.7).....	333
16.17	FISHING GROUND	334
16.17.1	Fishing grounds.....	335
16.18	FREE PORT AREA	336
16.18.1	Free port areas.....	336
16.19	HARBOUR AREA (ADMINISTRATIVE)	337
16.19.1	Administrative harbour areas (see S-4 – B-430.1).....	337
16.20	LOG POND	338
16.20.1	Log ponds (see S-4 – B-449.2).....	338
16.21	OIL BARRIER	339
16.21.1	Oil barriers (see S-4 – B-449.2).....	339
16.22	STRAIGHT TERRITORIAL SEA BASELINE	340
16.22.1	Straight Territorial Sea Baselines (see S-4 – B-440.4).....	340
16.23	TERRITORIAL SEA AREA	341
16.23.1	Territorial Seas (see S-4 – B-440.5).....	341
16.24	SUBMARINE TRANSIT LANE	343
16.24.1	Submarine transit lanes (see S-4 – B-441.5).....	343
16.25	PILOTAGE DISTRICT	345
16.25.1	Pilotage districts (see S-4 – B-XXX).....	345
16.26	COLLISION REGULATIONS LIMIT	346
16.26.1	Collision regulations limit (see S-4 – B-XXX).....	346
17	GEO FEATURES – RESTRICTED AREAS – OVERVIEW	347
17.1	MINEFIELDS (SEE S-4 – B-441.8)	347
17.2	DEGAUSSING RANGES (SEE S-4 – B-448)	347
17.3	NATURE RESERVES (SEE S-4 – B-437.3)	348
17.4	SPEED LIMITS (SEE S-4 – B-430.2)	348
17.5	ANCHORING RESTRICTED (SEE S-4 – B-431.4)	348
17.6	AREAS TO BE AVOIDED (SEE S-4 – B-435.7)	348
17.7	ENVIRONMENTALLY SENSITIVE SEA AREAS (SEE S-4 – B-437)	348
17.8	RESTRICTED AREA NAVIGATIONAL	349
17.8.1	Navigational restricted areas (see S-4 – B-422; B-430.2; B-431.4; B-435.7; B-435.11; B-437.1-7; B-439; B-439.2-4; B-441.1; B-445.9; B-445.11-12; B-446.4 and B-448.1).....	350
17.9	RESTRICTED AREA REGULATORY	351
17.9.1	Restricted areas in general (see S-4 – B-422; B-437.1-7; B-439; B-441.1; B-439.2-4; B-445.9; B-445.11-12; B-446.4 and B-448.1).....	352
18	GEO FEATURES – AIDS TO NAVIGATION – OVERVIEW	354
18.1	GEO FEATURES FORMING PARTS OF NAVIGATIONAL AIDS	354
18.2	RELATIONSHIPS	354
18.3	BUOYAGE SYSTEMS AND DIRECTION OF BUOYAGE (SEE S-4 – B-461)	356
18.3.1	Buoyage systems and direction of buoyage (see S-4 – B-461).....	356
18.3.1.1	Encoding IALA marks within IALA A or B.....	356
19	GEO FEATURES – LIGHTS	359
19.1	LIGHTS: GENERAL	359
19.1.1	Rhythms of lights (see S-4 – B-471.2).....	359
19.1.2	Types and functions of lights (see S-4 – B-471.1).....	359
19.1.3	Elevations of lights (see S-4 – B-471.6).....	359
19.1.4	Times of exhibition and exhibition conditions (see S-4 – B-473).....	360
19.1.4.1	Night lights.....	360
19.1.4.2	Unwatched lights (see S-4 – B-473.1).....	360
19.1.4.3	Occasional lights (see S-4 – B-473.2).....	360
19.1.4.4	Daytime lights (see S-4 – B-473.4).....	360
19.1.4.5	Fog lights (see S-4 – B-473.5).....	360
19.1.5	Leading lights (see S-4 – B-475.6).....	360
19.1.6	Lighthouses (see S-4 – B-457.3).....	361
19.1.7	Various special types of lights.....	361
19.1.8	Light structures.....	361

19.2	LIGHT ALL AROUND	363
19.2.1	<i>All around lights (see S-4 – B-470)</i>	365
19.3	LIGHT SECTORED	367
19.3.1	<i>Sectored lights (see S-4 – B-475)</i>	369
19.3.1.1	<i>Lights obscured by obstructions (see S-4 – B-475.3)</i>	370
19.3.1.2	<i>Directional lights (see S-4 – B-475.7-8)</i>	371
19.3.1.3	<i>Oscillating light sectors</i>	371
19.4	LIGHT FOG DETECTOR	374
19.4.1	<i>Fog detector lights (see S-4 – B-477)</i>	375
19.5	LIGHT AIR OBSTRUCTION	377
19.5.1	<i>Air obstruction lights (see S-4 – B-476.2)</i>	379
20	GEO FEATURES – BUOYS, BEACONS	380
20.1	LATERAL BUOYS	380
20.1.1	<i>Lateral buoys (see S-4 – B-461.3 and B-467)</i>	382
20.2	CARDINAL BUOYS	384
20.2.1	<i>Cardinal buoys (see S-4 – B-461.3 and B-467)</i>	386
20.3	ISOLATED DANGER BUOYS	389
20.3.1	<i>Isolated danger buoys (see S-4 – B-461.3 and B-467)</i>	391
20.4	SAFE WATER BUOYS	393
20.4.1	<i>Safe water buoys (see S-4 – B-461.3 and B-467)</i>	395
20.5	SPECIAL PURPOSE/GENERAL BUOYS	397
20.5.1	<i>Special purpose/general buoys (see S-4 – B-461.3 and B-467)</i>	400
20.6	EMERGENCY WRECK MARKING BUOYS	403
20.6.1	<i>Emergency wreck marking buoys (see S-4 – B-461.3 and B-467)</i>	405
20.7	INSTALLATION BUOYS	406
20.7.1	<i>Installation buoys (see S-4 – B-445.4)</i>	407
20.8	LATERAL BEACONS	409
20.8.1	<i>Lateral Beacons (see S-4 – B-461.3 and B-467)</i>	411
20.9	CARDINAL BEACONS	414
20.9.1	<i>Cardinal beacons (see S-4 – B-461.3 and B-467)</i>	416
20.10	ISOLATED DANGER BEACONS	419
20.10.1	<i>Isolated danger beacons (see S-4 – B-461.3 and B-467)</i>	421
20.11	SAFE WATER BEACONS	423
20.11.1	<i>Safe water beacons (see S-4 – B-461.3 and B-467)</i>	425
20.12	SPECIAL PURPOSE/GENERAL BEACONS	427
20.12.1	<i>Special purpose/general beacons (see S-4 – B-461.3 and B-467)</i>	430
20.12.2	<i>Signs and notice boards</i>	431
20.13	DAYMARKS	433
20.13.1	<i>Daymarks (see S-4 – B-455.9)</i>	436
20.14	LIGHT FLOATS	438
20.14.1	<i>Lights floats (see S-4 – B-462.8)</i>	440
20.15	LIGHT VESSELS	441
20.15.1	<i>Lights vessels (see S-4 – B-474.1-3)</i>	442
20.16	RETROREFLECTORS	443
20.16.1	<i>Retroreflectors (see S-4 – B-460.7)</i>	443
20.17	RADAR REFLECTORS	445
20.17.1	<i>Radar reflectors (see S-4 – B-455.8 and B-465)</i>	445
20.18	FOG SIGNALS	446
20.18.1	<i>Fog signals (see S-4 – B-451-454)</i>	447
21	GEO FEATURES – RADAR, RADIO	449
21.1	AUTOMATIC IDENTIFICATION SYSTEM (AIS) AIDS TO NAVIGATION (SEE S-4 – B-480-484)	449
21.2	PHYSICAL AIS AID TO NAVIGATION	450
21.2.1	<i>Physical Automatic Identification System (AIS) aids to navigation (see S-4 – B-480-484)</i>	450
21.3	VIRTUAL AIS AID TO NAVIGATION	452
21.3.1	<i>Virtual Automatic Identification System (AIS) aids to navigation (see S-4 – B-480-484)</i>	452
21.4	RADIO STATION	454

21.4.1	Radio stations (see S-4 – B-480-484)	455
21.4.2	Radio direction-finding stations (see S-4 – B-483)	455
21.5	RADAR TRANSPONDER BEACON	456
21.5.1	Radar beacons (see S-4 – B-486)	457
22	GEO FEATURES – SERVICES	459
22.1	PILOT BOARDING PLACE	459
22.1.1	Pilot boarding places (see S-4 – B-491.1-2)	459
22.1.2	Pilot stations ashore (see S-4 – B-491.4)	460
22.2	VESSEL TRAFFIC SERVICE AREA	461
22.2.1	Vessel traffic service area	461
22.3	COASTGUARD STATION	462
22.3.1	Coastguard stations (see S-4 – B-492)	462
22.4	WARNING SIGNAL STATIONS	464
22.4.1	Warning signal stations (see S-4 – B-494; B-496-7)	465
22.5	TRAFFIC SIGNAL STATIONS	466
22.5.1	Traffic signal stations (see S-4 – B-494-5)	466
22.6	RESCUE STATION	468
22.6.1	Rescue station (see S-4 – B-490 and B-493)	468
22.7	HARBOUR FACILITY	470
22.7.1	Harbour facilities (see S-4 – B-320 and B-321.5)	472
22.8	SMALL CRAFT FACILITY	473
22.8.1	Small craft facilities (see S-4 – B-320.1-2)	474
23	CARTOGRAPHIC FEATURES	475
23.1	TEXT PLACEMENT	475
23.1.1	Text placement	475
24	INFORMATION TYPES	476
24.1	CONTACT DETAILS	476
24.1.1	Contact details	476
24.2	SERVICE HOURS	478
24.2.1	Service hours	478
24.3	NON-STANDARD WORKING DAY	480
24.3.1	Non-standard working days	480
24.4	NAUTICAL INFORMATION	482
24.4.1	Nautical information	482
24.5	SPATIAL QUALITY	483
24.5.1	Spatial quality	483
25	ASSOCIATION NAMES	484
25.1	ADDITIONAL INFORMATION	484
25.2	AIDS TO NAVIGATION ASSOCIATION	484
25.3	ASL AGGREGATION	484
25.4	BRIDGE AGGREGATION	485
25.5	CAUTION AREA ASSOCIATION	485
25.6	DEEP WATER ROUTE AGGREGATION	485
25.7	FAIRWAY AGGREGATION	485
25.8	FAIRWAY AUXILIARY	486
25.9	ISLAND AGGREGATION	486
25.10	PILOTAGE DISTRICT ASSOCIATION	486
25.11	RANGE SYSTEM AGGREGATION	486
25.12	SPATIAL ASSOCIATION	487
25.13	STRUCTURE/EQUIPMENT	487
25.14	TEXT ASSOCIATION	487
25.15	TRAFFIC SEPARATION SCHEME AGGREGATION	488
25.16	TWO-WAY ROUTE AGGREGATION	488
25.17	UPDATED INFORMATION	488
26	ASSOCIATION ROLES	489

26.1	AUXILIARY TO	489
26.2	COMPONENT OF	489
26.3	CONSISTS OF	489
26.4	DEFINED FOR	489
26.5	DEFINES	489
26.6	HAS AUXILIARY	489
26.7	IDENTIFIES	489
26.8	INFORMATION PROVIDED FOR.....	489
26.9	POSITIONS.....	489
26.10	PROVIDES INFORMATION	489
26.11	SUPPORTED BY.....	490
26.12	SUPPORTS.....	490
26.13	UPDATES.....	490
27	GEO FEATURE ATTRIBUTE AND ENUMERATE DESCRIPTIONS	491
27.1	BEACON SHAPE (BCNSHP).....	491
27.2	BUILDING SHAPE (BUISHP).....	491
27.3	BUOY SHAPE (BOYSHP).....	492
27.4	BURIED DEPTH (BURDEP)	492
27.5	CALL SIGN (CALSGN)	493
27.6	CATEGORY OF AIRPORT/AIRFIELD (CATAIR)	493
27.7	CATEGORY OF ANCHORAGE (CATACH)	494
27.8	CATEGORY OF BRIDGE (CATBRG)	494
27.9	CATEGORY OF BUILT-UP AREA (CATBUA)	496
27.10	CATEGORY OF CABLE (CATCBL)	496
27.11	CATEGORY OF CANAL (CATCAN).....	497
27.12	CATEGORY OF CARDINAL MARK (CATCAM).....	497
27.13	CATEGORY OF CHECKPOINT (CATCHP)	498
27.14	CATEGORY OF COASTLINE (CATCOA)	498
27.15	CATEGORY OF CONVEYOR (CATCON)	498
27.16	CATEGORY OF CRANE (CATCRN).....	499
27.17	CATEGORY OF DAM (CATDAM).....	499
27.18	CATEGORY OF DISTANCE MARK (CATDIS)	500
27.19	CATEGORY OF DOCK (CATDOC)	500
27.20	CATEGORY OF DUMPING GROUND (CATDPG).....	500
27.21	CATEGORY OF FENCE (CATFNC).....	501
27.22	CATEGORY OF FERRY (CATFRY).....	501
27.23	CATEGORY OF FISHING FACILITY (CATFIF).....	502
27.24	CATEGORY OF FOG SIGNAL (CATFOG).....	502
27.25	CATEGORY OF FORTIFIED STRUCTURE (CATFOR)	503
27.26	CATEGORY OF GATE (CATGAT)	503
27.27	CATEGORY OF HARBOUR FACILITY (CATHAF).....	504
27.28	CATEGORY OF HULK (CATHLK)	505
27.29	CATEGORY OF ICE (CATICE)	506
27.30	CATEGORY OF INSTALLATION BUOY (CATINB)	506
27.31	CATEGORY OF LAND REGION (CATLND)	506
27.32	CATEGORY OF LANDMARK (CATLMK)	508
27.33	CATEGORY OF LATERAL MARK (CATLAM).....	510
27.34	CATEGORY OF LIGHT (CATLIT).....	510
27.35	CATEGORY OF MARINE FARM/CULTURE (CATMFA)	511
27.36	CATEGORY OF MILITARY PRACTICE AREA (CATMPA)	512
27.37	CATEGORY OF MOORING/WARPING FACILITY (CATMOR)	512
27.38	CATEGORY OF NAVIGATION LINE (CATNAV).....	513
27.39	CATEGORY OF OBSTRUCTION (CATOBS).....	513
27.40	CATEGORY OF OFFSHORE PLATFORM (CATOFFP)	515
27.41	CATEGORY OF OFFSHORE PRODUCTION AREA (CATPRA).....	516
27.42	CATEGORY OF OIL BARRIER (CATOLB)	516
27.43	CATEGORY OF PILE (CATPLE)	516
27.44	CATEGORY OF PILOT BOARDING PLACE (CATPIL)	517
27.45	CATEGORY OF PIPELINE/PIPE (CATPIP)	517

27.46	CATEGORY OF PRODUCTION AREA (CATPRA).....	518
27.47	CATEGORY OF PYLON (CATPYL).....	519
27.48	CATEGORY OF RADAR STATION (CATRAS)	519
27.49	CATEGORY OF RADAR TRANSPONDER BEACON (CATRTB)	519
27.50	CATEGORY OF RADIO STATION (CATROS)	520
27.51	CATEGORY OF RECOMMENDED TRACK (CATTRK)	521
27.52	CATEGORY OF RESCUE STATION (CATRSC).....	521
27.53	CATEGORY OF RESTRICTED AREA (CATREA).....	522
27.54	CATEGORY OF ROAD (CATROD)	524
27.55	CATEGORY OF RUNWAY (CATRUN).....	524
27.56	CATEGORY OF SCHEDULE.....	524
27.57	CATEGORY OF SEA AREA (CATSEA)	525
27.58	CATEGORY OF SHORELINE CONSTRUCTION (CATSLC)	529
27.59	CATEGORY OF SIGNAL STATION, TRAFFIC (CATSIT)	531
27.60	CATEGORY OF SIGNAL STATION, WARNING (CATSIW).....	531
27.61	CATEGORY OF SILO/TANK (CATSIL)	533
27.62	CATEGORY OF SLOPE (CATSLO).....	533
27.63	CATEGORY OF SMALL CRAFT FACILITY (CATSCF)	534
27.64	CATEGORY OF SPECIAL PURPOSE MARK (CATSPM).....	536
27.65	CATEGORY OF TIDAL STREAM (CAT_TS).....	540
27.66	CATEGORY OF TRAFFIC SEPARATION SCHEME (CATTSS).....	541
27.67	CATEGORY OF VEGETATION (CATVEG)	541
27.68	CATEGORY OF WATER TURBULENCE (CATWAT)	542
27.69	CATEGORY OF WEED/KELP (CATWED).....	543
27.70	CATEGORY OF WRECK (CATWRK)	543
27.71	COLOUR (COLOUR)	544
27.72	COLOUR PATTERN (COLPAT)	544
27.73	COMMUNICATION CHANNEL (COMCHA).....	545
27.74	CONDITION (CONDTN).....	545
27.75	CONTACT INSTRUCTIONS.....	545
27.76	DATE DISUSED	546
27.77	DATE END (DATEND)	546
27.78	DATE FIXED	546
27.79	DATE START (DATSTA)	547
27.80	DATE VARIABLE	547
27.81	DAY OF WEEK	548
27.82	DAY OF WEEK IS RANGE	548
27.83	DEPTH RANGE MAXIMUM VALUE (DRVAL2)	548
27.84	DEPTH RANGE MINIMUM VALUE (DRVAL1)	548
27.85	DIRECTIONAL.....	549
27.86	DISPLAY NAME.....	549
27.87	DISTANCE UNIT OF MEASUREMENT	549
27.88	DREDGED DATE	549
27.89	ELEVATION (ELEVAT)	550
27.90	ESTIMATED RANGE OF TRANSMISSION (ESTRNG)	550
27.91	EXHIBITION CONDITION OF LIGHT (EXCLIT)	550
27.92	EXPOSITION OF SOUNDING (EXPSOU)	551
27.93	FILE LOCATOR	551
27.94	FILE REFERENCE (TXTDSC, NTXTDS).....	551
27.95	FLARE STACK	552
27.96	FLIP BEARING	552
27.97	FREQUENCY SHORE STATION RECEIVES (SIGFRQ)	552
27.98	FREQUENCY SHORE STATION TRANSMITS (SIGFRQ).....	552
27.99	FUNCTION (FUNCTN).....	553
27.100	HEADLINE.....	556
27.101	HEIGHT (HEIGHT).....	556
27.102	HORIZONTAL CLEARANCE LENGTH.....	556
27.103	HORIZONTAL CLEARANCE VALUE (HORCLR)	557
27.104	HORIZONTAL CLEARANCE WIDTH	557
27.105	HORIZONTAL LENGTH (HORLEN)	557

27.106	HORIZONTAL WIDTH (HORWID)	557
27.107	ICE FACTOR (ICEFAC)	558
27.108	IN DISPUTE	558
27.109	IS MRCC	558
27.110	JURISDICTION (JRSDTN)	558
27.111	LANGUAGE	559
27.112	LIFTING CAPACITY (LIFCAP)	559
27.113	LIGHT CHARACTERISTIC (LITCHR)	559
27.114	LIGHT VISIBILITY (LITVIS)	561
27.115	LINKAGE	562
27.116	MAGNETIC ANOMALY VALUE MAXIMUM (VALLMA)	562
27.117	MAGNETIC ANOMALY VALUE MINIMUM	562
27.118	MAJOR LIGHT	562
27.119	MARKS NAVIGATIONAL – SYSTEM OF (MARSYS)	563
27.120	MAXIMUM PERMITTED DRAUGHT	563
27.121	MEASURED DISTANCE	563
27.122	MMSI CODE	564
27.123	MOIRÉ EFFECT	564
27.124	MULTIPLICITY KNOWN	564
27.125	NAME (<i>OBJNAM, NOBJNM</i>)	564
27.126	NAME OF RESOURCE	564
27.127	NATIONALITY (NATION)	565
27.128	NATURE OF CONSTRUCTION (NATCON)	565
27.129	NATURE OF SURFACE (NATSUR)	566
27.130	NATURE OF SURFACE – QUALIFYING TERMS (NATQUA)	567
27.131	NUMBER OF FEATURES	568
27.132	OBSERVATION DEPTH	568
27.133	ORIENTATION VALUE (ORIENT)	568
27.134	PICTORIAL REPRESENTATION (PICREP)	568
27.135	PRODUCT (PRODCT)	569
27.136	QUALITY OF VERTICAL MEASUREMENT (QUASOU)	570
27.137	RADAR BAND	571
27.138	RADAR CONSPICUOUS (CONRAD)	571
27.139	RADIUS (RADIUS)	572
27.140	REFERENCE LOCATION	572
27.141	REFERENCE TIDE	572
27.142	REFERENCE TIDE TYPE	572
27.143	REFERENCE YEAR OF MAGNETIC VARIATION (RYRMGV)	573
27.144	REGULATION CITATION	573
27.145	REPORTED DATE	573
27.146	RESTRICTION (RESTRN)	573
27.147	SCALE MINIMUM (SCAMIN)	576
27.148	SECTOR BEARING	577
27.149	SECTOR LINE LENGTH	577
27.150	SIGNAL DURATION	577
27.151	SIGNAL FREQUENCY (SIGFRQ)	578
27.152	SIGNAL GENERATION (SIGGEN)	578
27.153	SIGNAL GROUP (SIGGRP)	578
27.154	SIGNAL PERIOD (SIGPER)	579
27.155	SIGNAL STATUS	579
27.156	SPEED LIMIT	579
27.157	SPEED MAXIMUM (CURVEL)	580
27.158	SPEED MINIMUM	580
27.159	STATION NAME	580
27.160	STATION NUMBER	580
27.161	STATUS (STATUS)	581
27.162	STREAM DEPTH	582
27.163	SWEPT DATE	582
27.164	TECHNIQUE OF VERTICAL MEASUREMENT (TECSOU)	583
27.165	TELECOMMUNICATION IDENTIFIER	584

27.166	TELECOMMUNICATION SERVICE	584
27.167	TEXT (<i>INFORM, NINFOM</i>).....	585
27.168	TEXT JUSTIFICATION	585
27.169	TEXT TYPE.....	585
27.170	TIME OF DAY END	585
27.171	TIME OF DAY START	586
27.172	TIME REFERENCE	586
27.173	TIME RELATIVE TO TIDE	586
27.174	TOPMARK/DAYMARK SHAPE (<i>TOPSHP</i>)	586
27.175	TRAFFIC FLOW (<i>TRAFIC</i>)	589
27.176	UNDERLYING LAYER.....	590
27.177	VALUE OF ANNUAL CHANGE IN MAGNETIC VARIATION (<i>VALACM</i>)	590
27.178	VALUE OF DEPTH CONTOUR (<i>VALDCO</i>)	590
27.179	VALUE OF MAGNETIC VARIATION (<i>VALMAG</i>)	590
27.180	VALUE OF MAXIMUM RANGE (<i>VALMXR</i>)	591
27.181	VALUE OF NOMINAL RANGE (<i>VALNMR</i>).....	591
27.182	VALUE OF SOUNDING (<i>VALSOU</i>)	591
27.183	VERTICAL CLEARANCE VALUE (<i>VERCLR</i>)	592
27.184	VERTICAL DATUM (<i>VERDAT</i>).....	592
27.185	VERTICAL LENGTH (<i>VERLEN</i>)	594
27.186	VESSEL CLASS	595
27.187	VIRTUAL AIS AID TO NAVIGATION TYPE	595
27.188	VISUALLY CONSPICUOUS (<i>CONVIS</i>).....	596
27.189	WATER LEVEL EFFECT (<i>WATLEV</i>).....	596
27.190	WATERWAY DISTANCE	597
27.191	WAVE LENGTH VALUE	597
28	META FEATURE AND SPATIAL ATTRIBUTE AND ENUMERATE DESCRIPTIONS	598
28.1	CATEGORY OF TEMPORAL VARIATION	598
28.2	DATA ASSESSMENT.....	598
28.3	FULL SEAFLOOR COVERAGE ACHIEVED	599
28.4	HORIZONTAL DISTANCE UNCERTAINTY (<i>HORACC</i>)	599
28.5	HORIZONTAL POSITION UNCERTAINTY (<i>POSACC</i>).....	599
28.6	LEAST DEPTH OF DETECTED FEATURES MEASURED	599
28.7	LINE SPACING MAXIMUM (<i>SDISMX</i>).....	600
28.8	LINE SPACING MINIMUM (<i>SDISMN</i>).....	600
28.9	MAXIMUM DISPLAY SCALE (<i>CSCALE</i>)	600
28.10	MEASUREMENT DISTANCE MAXIMUM	601
28.11	MEASUREMENT DISTANCE MINIMUM	601
28.12	MINIMUM DISPLAY SCALE	601
28.13	ORIENTATION UNCERTAINTY	602
28.14	QUALITY OF HORIZONTAL MEASUREMENT (<i>QUAPOS</i>).....	602
28.15	SCALE VALUE MAXIMUM (<i>SCVAL1</i>).....	603
28.16	SCALE VALUE MINIMUM (<i>SCVAL2</i>).....	603
28.17	SIGNIFICANT FEATURES DETECTED	603
28.18	SIZE OF FEATURES DETECTED	604
28.19	SOURCE	604
28.20	SURVEY AUTHORITY (<i>SURATH</i>).....	604
28.21	SURVEY TYPE (<i>SURTYP</i>)	604
28.22	UNCERTAINTY FIXED (<i>SOUACC, VERACC</i>)	606
28.23	UNCERTAINTY VARIABLE	606
29	COMPLEX ATTRIBUTES.....	607
29.1	DIRECTIONAL CHARACTER.....	607
29.2	FEATURE NAME.....	607
29.3	FEATURES DETECTED.....	607
29.4	FIXED DATE RANGE	607
29.5	FREQUENCY PAIR (<i>SIGFRQ</i>).....	608
29.6	HORIZONTAL CLEARANCE FIXED	608
29.7	HORIZONTAL CLEARANCE OPEN	608

29.8	INFORMATION	608
29.9	LIGHT SECTOR	609
29.10	MEASURED DISTANCE VALUE.....	609
29.11	MULTIPLICITY OF FEATURES	609
29.12	ONLINE RESOURCE	609
29.13	ORIENTATION.....	610
29.14	PERIODIC DATE RANGE.....	610
29.15	RADAR WAVE LENGTH.....	610
29.16	RHYTHM OF LIGHT.....	611
29.17	SCHEDULE BY DAY OF WEEK.....	611
29.18	SECTOR CHARACTERISTICS	611
29.19	SECTOR INFORMATION	611
29.20	SECTOR LIMIT	612
29.21	SECTOR LIMIT ONE	612
29.22	SECTOR LIMIT TWO.....	612
29.23	SHAPE INFORMATION	613
29.24	SIGNAL SEQUENCE.....	613
29.25	SPEED.....	613
29.26	SURFACE CHARACTERISTICS	613
29.27	SURVEY DATE RANGE.....	614
29.28	TELECOMMUNICATIONS	614
29.29	TIDAL STREAM PANEL VALUES	614
29.30	TIDAL STREAM VALUE	614
29.31	TIME INTERVALS BY DAY OF WEEK	615
29.32	TOPMARK	615
29.33	UPDATE DESCRIPTION	615
29.34	VALUE OF LOCAL MAGNETIC ANOMALY	615
29.35	VERTICAL CLEARANCE CLOSED	616
29.36	VERTICAL CLEARANCE FIXED.....	616
29.37	VERTICAL CLEARANCE OPEN	616
29.38	VERTICAL CLEARANCE SAFE.....	616
29.39	VERTICAL UNCERTAINTY	617
29.40	VESSEL SPEED LIMIT	617
30	ECDIS SYSTEM (PORTRAYAL) ATTRIBUTES.....	618
30.1	DEFAULT CLEARANCE DEPTH	618
30.2	FLARE ANGLE	618
30.3	IN THE WATER	618
30.4	SECTOR EXTENSION	618
30.5	SURROUNDING DEPTH	619
31	UPDATING (SEE S-4 – B-600).....	620
31.1	ISSUING UPDATES IN ADVANCE	620
31.1.1	<i>Advance notification of changes to traffic separation schemes.....</i>	621
31.2	GUIDELINES FOR ENCODING TEMPORARY AND PRELIMINARY ENC UPDATES.....	621
31.2.1	<i>Introduction.....</i>	621
31.2.2	<i>Temporary (T) Notices to Mariners (see S-4 – B-633).....</i>	621
31.2.3	<i>Preliminary (P) Notices to Mariners (see S-4 – B-634).....</i>	624

Document Control

Version	Version Type	Date	Approved By	Signed Off By	Role
0.0.0	Editing Committee Draft	Jan 2014	TSMAD	J. Wootton	DCEG Coordinator
0.0.1	Baseline Version 1	Apr 2014	TSMAD	J. Wootton	DCEG Coordinator
0.0.2	Baseline Version	Aug 2016	S-101PT	J. Wootton	DCEG Coordinator
0.0.2	Baseline Version 2	Mar 2017	S-101PT	J. Wootton	DCEG Coordinator

1 Overview

1.1 Preface

The “Data Classification and Encoding Guide” has been developed to provide consistent, standardized instructions for encoding S-100 compliant ENC data. This document has been laid out, as far as possible, along the lines of the IHO publication S-4, Part B “Chart Specifications of the IHO – Medium and Large-Scale National and International (INT) Charts”.

The purpose of the Data Classification and Encoding Guide is to facilitate S-101 encoding to meet IHO standards for the proper display of ENC in an ECDIS. The document describes how to encode information that the cartographer considers relevant to an ENC. The content of an ENC is at the discretion of the producing authority provided that the conventions described within this document are followed. A “producing authority” is a Hydrographic Office (HO) or an organization authorized by a government, HO or other relevant government institution to produce ENCs.

The entire S-100 Standard, including the S-101 ENC Product Specification, is available at the following web site, <http://www.iho.int>.

1.2 S-101 Annex A; Data Classification and Encoding Guide - Metadata

Note: This information uniquely identifies this Annex to the Product Specification and provides information about its creation and maintenance.

Title: The International Hydrographic Organization Electronic Navigational Chart Product Specification, Annex A – Data Classification and Encoding Guide

Version: 0.0.2

Date: March 2017

Language: English

Classification: Unclassified

Contact: IHO Secretariat
4b Quai Antione 1er
B.P. 445
MC 98011 MONACO CEDEX
Telephone: +377 93 10 81 00
Fax: +377 93 10 81 40

URL: www.iho.int

Identifier: S-101 Annex A

Maintenance: Changes to S-101 Annex A; Data Classification and Encoding Guide are coordinated by the IHO ENC Maintenance Working Group (ENCWG) and must be made available via the IHO web site.

1.3 Terms, definitions and abbreviations

1.3.1 Terms and definitions

aggregation

special form of **association** that specifies a whole-part relationship between the aggregate (whole) and a component (see composition)

association

semantic relationship between two or more classifiers that specifies connections among their instances

NOTE: A binary association is an association among exactly two classifiers (including the possibility of an association from a classifier to itself)

attribute

named property of an entity

NOTE: Describes the geometrical, topological, thematic, or other characteristic of an entity

composition

a strong **aggregation**; if a container object is deleted than all of its containee objects are deleted as well (that is, containee objects cannot exist without the container object)

curve

1-dimensional **geometric primitive**, representing the continuous image of a line

NOTE: The **boundary** of a **curve** is the **set** of **points** at either end of the **curve**. If the **curve** is a cycle, the two ends are identical, and the **curve** (if topologically closed) is considered to not have a boundary. The first **point** is called the **start point**, and the last is the **end point**. Connectivity of the curve is guaranteed by the “continuous image of a line”

enumeration

A fixed list of valid identifiers of named literal values. Attributes of an enumerated type may only take values from this list (source: ISO 19136:XX, *Geographic information — Geography Markup Language (GML)*)

feature

Abstraction of real world phenomena

NOTE: A feature may occur as a type or an instance. The terms “feature type” or “feature instance” should be used when only one is meant

EXAMPLE: The feature instance named “Eiffel Tower” may be classified with other phenomena into a feature type “tower”

geometric primitive

geometric object representing a single, connected, homogeneous element of geometry

NOTE: Geometric primitives are non-decomposed objects that present information about geometric configuration. They include **points**, **curves**, **surfaces**

maximum display scale

the largest value of the ratio of the linear dimensions of features of a dataset presented in the display and the actual dimensions of the features represented (largest scale) of the scale range of the dataset

minimum display scale

the smallest value of the ratio of the linear dimensions of features of a dataset presented in the display and the actual dimensions of the features represented (smallest scale) of the scale range of the dataset

point

0-dimensional geometric primitive, representing a position

NOTE: The **boundary** of a point is the empty set

pointset

definition required

skin of the earth

a subset of the geographic (geo) features that must create a complete non-overlapping coverage of the area of data coverage of an ENC dataset

surface

connected 2-dimensional geometric primitive, representing the continuous image of a region of a plane

NOTE: The boundary of a surface is the set of oriented, closed **curves** that delineate the limits of the surface

1.3.2 Abbreviations

ECDIS Electronic Chart Display and Information System

ENC Electronic Navigational Chart

GML	Geography Markup Language
GNSS	Global Navigation Satellite System
HO	Hydrographic Office
IHO	International Hydrographic Organization
IMO	International Maritime Organization
ISO	International Organization for Standardization
SENC	System Electronic Navigational Chart
SOLAS	Safety of Life at Sea
TSMAD	Transfer Standard Maintenance and Application Development Working Group
UNCLOS	United Nations Convention on the Law of the Sea

1.4 Use of language

Within this document:

“Must” indicates a mandatory requirement;

“Should” indicates an optional requirement, that is the recommended process to be followed, but is not mandatory;

“May” means “allowed to” or “could possibly”, and is not mandatory.

1.5 Maintenance

Changes to the Data Classification and Encoding Guide must occur in accordance with the S-101 ENC Product Specification clause 1.5.1.

2 General

The S-101 Data Classification and Encoding Guide describes how data describing the real world should be captured using the types defined in the S-101 Feature Catalogue (see S-101 XXXX). It provides the encoding rules and guidance required to create S-101 ENCs. This standard is specifically concerned with those entities in the real world that are of relevance to hydrography. This hydrographic regime is considered to be geo-spatial. As a result, the model defines real world entities as a combination of descriptive and spatial characteristics. Within the model these sets of characteristics are defined in terms of feature, spatial and information types. A type is defined as a stereotype of class that is used to specify a domain of instances (objects) together with the operations applicable to the objects. A type may have attributes and may be related to other types.

The types used within S-101 are described below. Within this document feature types, information types, associations and attributes appear in **bold text**.

2.1 Feature types

Feature types contain descriptive attributes and do not contain any geometry (that is, information about the shape and position of a real world entity).

Features have two aspects – feature type and feature instance. A feature type is a class and is defined in a Feature Catalogue. A feature instance is a single occurrence of the feature type and represented as an object in a dataset. A feature instance is located by a relationship to one or more spatial instances. A feature instance may exist without referencing a spatial instance.

S-101 makes use of the following feature types:

Geographic (Geo) feature type – carries the descriptive characteristics of a real world entity.

Aggregated feature type – a relationship between two or more feature types where the aggregation feature is made up of component features.

EXAMPLE: **Bridge** feature may be composed of multiple **Span** features and may also include lights and other features which make up the **Bridge**. In such cases the spans and other components of the bridge are associated with the feature **Bridge** using the associations **Bridge Aggregation** and **Bridge Association**

Cartographic feature type – contains information about the cartographic representation (including text) of real world entities.

Meta feature type – contains information about other features.

2.1.1 Multiple features

On some sources, multiple features in close proximity are generalised to a single feature with a text string indicating the presence of the other features. In such cases, where it is considered that this information may be useful for visual navigation, one feature of the appropriate class should be encoded and the true number of features, if known, must be encoded using the complex attribute **multiplicity of features**, sub-attribute **number of features**, with Boolean sub-attribute **multiplicity known** set to *True* (see clause X.X). If the true number of features is not known, **multiplicity of features** Boolean sub-attribute **multiplicity known** must be populated as *False*. If **multiplicity of features** is not an allowable attribute for the feature, multiplicity may be indicated using the information class **Nautical Information** (see clause X.X), complex attribute **information**, sub-attribute **text** (for example *3 trees*), associated to the relevant feature using the association **additional information**. If the true number of features is not known, the text "*more than one*" should be encoded using **information (text)** on the associated **Nautical Information**.

Multiple submerged features in close proximity, which have been generalised to a single feature, should not have the multiplicity indicated unless the multiplicity has some significance to safe navigation. This is so as to minimise the presence of ECDIS "information" symbols, which may contribute to screen clutter (see clause X.X).

For the encoding of multiple, identical lights using the attribute complex **multiplicity of features**, see table in clause X.X.

For the encoding of leading lights that are required to be merged due to scale, see clause X.X.

There is no method within ENC to indicate to the mariner that a feature has not been encoded in its true position, therefore it is considered important for features to be encoded in their true position to provide the mariner with an accurate representation of the real world.

Encoders are advised, therefore, that if it is required to encode a feature which has been displaced on the paper chart for cartographic reasons, it should be captured in its real-world position on the ENC.

2.2 Geometric primitives

The allowable geometric primitive for each feature type is defined in the Feature Catalogue. Within this document, allowable primitives are included in the tables containing a description of each feature type. Allowable geometric primitives are point, pointset, curve and surface.

Each spatial value must be referenced by at least one feature instance.

Within this document, allowable primitives are included in the description of each feature type. For easy reference, Table 2.1 below summarises the allowable geometric primitives for each feature type. In the Table, abbreviations are as follows: point (P), pointset (A), curve (C) and surface (S). A feature having no allowable geometric primitive is annotated as none (N).

Administration Area			S	
Anchorage Area	P		S	
Archipelagic Sea Lane Axis		C		
Beacon Lateral	P			
Berth	P	C	S	
Built-up Area	P		S	
Buoy Installation	P			
Buoy Safe Water	P			
Cable Overhead		C		
Cargo Transshipment Area	P		S	
Checkpoint	P		S	
Collision Regulations Limit		C		
Conveyor		C	S	
Custom Zone			S	
Deep Water Route				N
Depth Area			S	
Discoloured Water	P		S	
Dredged Area			S	
Dyke		C	S	
Fairway System				N
Fishery Zone			S	
Floating Dock	P	C	S	
Foul Ground	P	C	S	
Gridiron			S	
Hulk	P		S	
Inshore Traffic Zone			S	
Land Area	P	C	S	
Landmark	P	C	S	
Light Float	P			
Light Vessel	P			
Log Pond	P		S	
Military Practice Area	P		S	
Obstruction	P	C	S	
Oil Barrier		C		
Pilot Boarding Place	P		S	
Pipeline Submarine/On Land		C		
Production/Storage Area	P		S	
Radar Range			S	
Airport/Airfield	P		S	
Archipelagic Sea Lane				N
Beacon Cardinal	P			
Beacon Safe Water	P			
Bridge		C	S	N
Buoy Cardinal	P			
Buoy Isolated Danger	P			
Buoy Special Purpose/General	P			
Cable Submarine		C		
Causeway		C	S	
Coastguard Station	P		S	
Contiguous Zone			S	
Crane	P	C	S	
Dam		C	S	
Deep Water Route Centreline		C		
Depth Contour		C		
Distance Mark	P			
Dry Dock			S	
Exclusive Economic Zone			S	
Fence/Wall		C		
Fishing Facility	P	C	S	
Fog Signal	P			
Free Port Area			S	
Harbour Area (Administrative)			S	
Ice Area			S	
Island Group				N
Land Elevation	P	C		
Light Air Obstruction	P			
Light Fog Detector	P			
Local Magnetic Anomaly	P	C	S	
Magnetic Variation	P	C	S	
Mooring/Warping Facility	P	C	S	
Offshore Platform	P		S	
Physical AIS Aid to Navigation	P			
Pilotage District			S	
Pontoon	P	C	S	
Pylon/Bridge Support	P		S	
Radar Reflector	P			
Anchor Berth	P		S	
Archipelagic Sea Lane Area			S	
Beacon Isolated Danger	P			
Beacon Special Purpose/General	P			
Building	P		S	
Buoy Emergency Wreck Marking	P			
Buoy Lateral	P			
Cable Area			S	
Canal		C	S	
Caution Area	P		S	
Coastline		C		
Continental Shelf Area			S	
Current – Non-gravitational	P	C	S	
Daymark	P			
Deep Water Route Part			S	
Depth – No Bottom Found	A			
Dock Area			S	
Dumping Ground	P		S	
Fairway			S	
Ferry Route		C	S	
Fishing Ground			S	
Fortified Structure	P	C	S	
Gate	P	C	S	
Harbour Facility	P		S	
Information Area	P	C	S	
Lake			S	
Land Region	P	C	S	
Light All Around	P			
Light Sector	P			
Lock Basin			S	
Marine Farm/Culture	P	C	S	
Navigation Line		C		
Offshore Production Area			S	
Pile	P	C	S	
Pipeline Overhead		C		
Precautionary Area	P		S	
Radar Line		C		
Radar Station	P			

Radar Transponder Beacon	P			
Railway		C		
Recommended Route Centreline		C		
Rescue Station	P		S	
Retroreflector	P			
Runway	P	C	S	
Seabed Area	P	C	S	
Signal Station Traffic	P		S	
Slope Topline		C		
Sounding	A			
Spring	P			
Submarine Transit Lane			S	
Tidal Stream – Flood/Ebb	P		S	
Traffic Separation Line		C		
Traffic Separation Scheme Crossing			S	
Traffic Separation Zone			S	
Two-way Route Part			S	
Vegetation	P	C	S	
Water Turbulence	P	C	S	
Wind Turbine	P			

Radio Calling-in Point	P	C		
Rapids	P	C	S	
Recommended Track		C		
Restricted Area Navigational			S	
River				
Sandwave	P	C	S	
Seaplane Landing Area	P		S	
Signal Station Warning	P	C	S	
Sloping Ground	P		S	
Span Fixed			S	
Straight Territorial Sea Baseline		C	S	
Swept Area			S	
Tidal Stream Panel Data	P		S	
Traffic Separation Scheme		C	S	
Traffic Separation Scheme Lane Part		C		
Tunnel			S	
Underwater/Awash Rock	P			N
Vessel Traffic Service Area			S	
Waterfall	P			
Wreck	P		S	

Radio Station	P			
Range System				N
Recommended Traffic Lane Part	P		S	
Restricted Area Regulatory			S	
Road		C	S	
Sea Area/Named Water Area	P		S	
Shoreline Construction	P	C	S	
Silo/Tank	P		S	
Small Craft Facility	P		S	
Span Opening		C	S	
Submarine Pipeline Area	P		S	
Territorial Sea Area			S	
Tideway		C	S	
Traffic Separation Scheme Boundary		C		
Traffic Separation Scheme Roundabout			S	
Two-way Route				N
Unsurveyed Area			S	
Virtual AIS Aid to Navigation	P			
Weed/Kelp	P		S	

Data Coverage			S	
Quality of Bathymetric Data			S	
Sounding Datum			S	

Local Direction of Buoyage			S	
Quality of Non-Bathymetric Data			S	
Update Information	P	C	S	

Navigational System of Marks			S	
Quality of Survey		C	S	
Vertical Datum of Data			S	

Text Placement	P			
----------------	---	--	--	--

Contact Details				N
Service Hours				N

Nautical Information				N
Spatial Quality				N

Non-Standard Working Day				N
--------------------------	--	--	--	---

Table 2.1 Features permitted for ENC and their geometric primitives

2.2.1 Capture density guideline

It is recommended that curves and surface boundaries should not be encoded at a point density greater than 0.3mm at the maximum display scale for the ENC data.

[Note: Compilation scale is the scale the data is captured to, and is not stored in the dataset. Only minimum and maximum display scales are stored in the dataset.]

A curve consists of one or more curve segments. Each curve segment is defined as a loxodromic line on WGS84. Long lines may need to have additional coordinates inserted to cater for the effects of projection change.

The presentation of line styles may be affected by curve length. Therefore, the encoder must be aware that splitting a curve into numerous small curves may result in poor symbolization.

[consider diagram]

2.3 Information types

An information type is an identifiable object that can be associated with features in order to carry information particular to the associated features. An example of the use of an information type may be the requirement to include a note about overhead cables. Information types can also be associated with other information types. This may be done where there is further supplementary information that is relevant to the information type.

Information types carry attributes but not geometry.

2.4 Attributes

Attributes may be simple type or complex type. Complex (C) attributes are aggregates of other attributes that can be simple type or complex type. Simple attributes are assigned to one of 8 types (see clause X.X).

The binding of attributes to feature types, the binding of attributes to attributes to construct complex attributes, and attribute multiplicity is defined in the Feature Catalogue. Within this document, the allowable attributes are included in the description of each feature type, as well as the allowable values for enumeration type attributes.

2.4.1 Multiplicity

In order to control the number of allowed attribute values or sub-attribute instances within a complex attribute, S-100 uses the concept of multiplicity. This defines lower and upper limits for the number of values, whether the order of the instances has meaning and if an attribute is mandatory or not. Common examples are shown in the table below:

Format : *MinOccurs, MaxOccurs* (if * Infinite) (*ordered*) – sequential

Multiplicity	Explanation
0,1	An instance is not required; there can be only one instance.
1,1	An instance is required and there must only be one instance.
0,*	An instance is not required and there can be an infinite number of instances.
1,*	An instance is required and there can be an infinite number of instances.
1,* (ordered)	An instance is required and there can be an infinite number of instances, the order of which has a specific meaning.
2,2	Two instances are required and no more than two.

Note: The function of the S-57 attribute type “List” has been replaced by Enumeration (EN) with an upper limit of multiplicity greater than 1. This means that when more than one value is needed for an enumerated attribute, the attribute code is populated multiple times with the required values.

Example: A red and white tower is encoded with attribute **colour** = 3 (red) and **colour** = 1 (white). Within this document, this example would be indicated as “**colour** = 3,1”.

2.4.2 Simple attribute types

Each simple attribute is assigned to one of 9 types:

- EN Enumeration: A fixed list of valid identifiers of named literal values. Attributes of an enumerated type may only take values from this list.
- CL Codelist: An open enumeration, or the identifier of a vocabulary (mapping between codes, labels and definitions).
- BO Boolean: A value representing binary logic. The value can be either *True* or *False*. The default state for Boolean type attributes (that is, where the attribute is not populated for the feature) is *False*.
- RE Real: A signed Real (floating point) number consisting of a mantissa and an exponent. The representation of a real is encapsulation and usage dependent.
Examples: 23.501, -0.0001234, -23.0, 3.141296
- IN Integer: A signed integer number. The representation of an integer is encapsulation and usage dependent.
Examples: 29, -65547
- TE Free text: A CharacterString, that is an arbitrary-length sequence of characters including accents and special characters from a repertoire of one of the adopted character sets.
- TD Truncated Date: A truncated date allows a partial date to be encoded as an extension to the ISO 8601 compliant date attribute type values for year, month and day according to the Gregorian Calendar. Character encoding of a date is a string which follows the calendar date

format (complete representation, basic format) for date specified by ISO 8601:2004. See clause X.X.

Example: 19980918 (YYYYMMDD)

TI Time: A time is given by an hour, minute and second. Character encoding of a time is a string that follows the local time (complete representation, basic format) format defined in ISO 8601:2004.

Time zone according to UTC is optional.

Example: 183059 or 183059+0100 or 183059Z

The complete representation of the time of 27 minutes and 46 seconds past 15 hours locally in Geneva (in winter one hour ahead of UTC), and in New York (in winter five hours behind UTC), together with the indication of the difference between the time scale of local time and UTC, are used as examples.

Geneva: 152746+0100

New York: 152746-0500

DT Date and Time: A DateTime is a combination of a date and a time type. Character encoding of a DateTime shall follow ISO 8601:2004 (see TD and TI above and clause X.X).

Example: 19850412T101530

Real or integer attribute values must not be padded by non-significant zeroes. For example, for a signal period of 2.5 seconds, the value populated for the attribute **signal period** must be 2.5 and not 02.50.

2.4.3 Mandatory and conditional attributes

Some attributes are mandatory and must be populated for a given feature type. There are some reasons why attribute values may be considered mandatory:

- They are required to support correct portrayal;
- Certain features make no logical sense without specific attributes;
- Some attributes are required for safety of navigation.

Within this document, mandatory attributes (multiplicity 1,1; 1,n (n>1); or 1,*) are identified in the description of each feature type. For easy reference, Table 2.2 below summarises the mandatory attributes for each feature type (note that mandatory sub-attributes of complex attributes are not included in this table):

Feature	Mandatory Attributes
Administration Area	jurisdiction
Archipelagic Sea Lane Part	nationality
Archipelagic Sea Lane Axis	nationality
Beacon Cardinal	beacon shape category of cardinal mark colour
Beacon Isolated Danger	beacon shape colour
Beacon Lateral	beacon shape category of lateral mark colour
Beacon Safe Water	beacon shape colour
Beacon Special Purpose/General	beacon shape category of special purpose mark colour
Berth	feature name
Bridge	over navigable water: category of bridge other cases: none
Buoy Cardinal	buoy shape category of cardinal mark colour
Buoy Emergency Wreck marking	buoy shape colour
Buoy Installation	buoy shape colour
Buoy Isolated Danger	buoy shape colour

Feature	Mandatory Attributes
Buoy Lateral	buoy shape category of lateral mark colour
Buoy Safe Water	buoy shape colour
Buoy Special Purpose/General	buoy shape category of special purpose mark colour
Cable Overhead	over navigable water, one of: vertical clearance fixed or vertical clearance safe other cases: none
Contiguous Zone	nationality
Continental Shelf Area	nationality
Conveyor	over navigable water: vertical clearance fixed other cases: none
Current – Non-gravitational	orientation speed
Custom Zone	nationality
Daymark	colour topmark shape
Deep Water Route Centreline	category of recommended track orientation traffic flow
Deep Water Route Part	depth range minimum value orientation traffic flow
Depth Area	depth range maximum value depth range minimum value
Depth Contour	value of depth contour
Distance Mark	measured distance value
Dredged Area	depth range minimum value
Exclusive Economic Zone	nationality
Ferry Route	category of ferry
Fishery Zone	nationality
Fog Signal	category of fog signal
Gate	if navigable at maximum display scale for the data: horizontal clearance open
Harbour Facility	category of harbour facility
Ice Area	category of ice
Island Group	feature name
Land Elevation	elevation
Land Region	at least one of: category of land region feature name
Landmark	category of landmark visually conspicuous
Light All Around	colour rhythm of light
Light Sector	light sector rhythm of light
Light Float	colour
Light Vessel	colour
Local Magnetic Anomaly	value of local magnetic anomaly
Magnetic Variation	reference year for magnetic variation value of annual change in magnetic variation value of magnetic variation
Marine Farm/Culture	water level effect at least one of: value of sounding vertical length
Mooring/Warping Facility	category of mooring/warping facility
Navigation Line	category of navigation line orientation
Obstruction	water level effect at least one of: value of sounding height
Offshore Platform	water level effect

Feature	Mandatory Attributes
Pipeline Overhead	over navigable water: vertical clearance fixed other cases: none
Production Area	category of production area
Pylon/Bridge Support	category of pylon
Radio Calling-in Point	orientation (point features only) traffic flow
Radar Line	orientation
Radar Transponder Beacon	category of radar transponder beacon
Recommended Route Centreline	category of recommended track
Recommended Track	category of recommended track orientation traffic flow
Recommended Traffic Lane Part	orientation
Restricted Area Navigational	restriction
Restricted Area Regulatory	at least one of: category of restricted area restriction
Sea Area/Named Water Area	at least one of: category of sea area feature name
Seabed Area	surface characteristics
Signal Station Traffic	category of signal station traffic
Signal Station Warning	category of signal station warning
Small Craft Facility	category of small craft facility
Span Fixed	vertical clearance fixed
Span Opening	vertical clearance closed vertical clearance open
Straight Territorial Sea Baseline	nationality
Swept Area	depth range minimum value
Territorial Sea Area	nationality
Tidal Stream – Flood/Ebb	category of tidal stream orientation speed
Tidal Stream Panel Data	station name tidal stream panel values
Traffic Separation Scheme Lane Part	orientation (except when the lane part is a junction)
Two-way Route Part	orientation traffic flow
Underwater/Awash Rock	value of sounding water level effect
Vegetation	category of vegetation
Virtual AIS Aid to Navigation	virtual AIS aid to navigation type
Water Turbulence	category of water turbulence
Wreck	water level effect at least one of: category of wreck value of sounding
Data Coverage	maximum display scale minimum display scale
Local Direction of Buoyage	orientation
Navigational System of Marks	marks navigational – system of
Quality of Bathymetric Data	category of temporal variation data assessment features detected full seafloor coverage achieved horizontal position uncertainty vertical position uncertainty
Quality of Non-bathymetric Data	category of temporal variation horizontal position uncertainty
Quality of Survey	survey authority survey date range survey type
Sounding Datum	vertical datum
Update Information	update description
Vertical Datum	vertical datum

Feature	Mandatory Attributes
Text Placement	text justification one of: text text type
Nautical Information	information
Non-Standard Working Day	at least one of: date fixed date variable
Service Hours	schedule by day of week

Table 2.2 Mandatory attributes

NOTE 1: In the Tables below describing each feature and its attributes, mandatory attributes are described with a multiplicity of “1,1” “1,n” (n>1); or “1,*”. Note that sub-attributes of complex attributes, as well as the complex attribute itself, may also be designated as mandatory (see NOTE 2 below). “Conditional” mandatory attributes are not identified in the Tables below other than by comments in the Remarks for the relevant feature, but are indicated in Table 2.2 above by the following additional text:

<i>over navigable water</i>	for Bridge, Cable Overhead, Conveyor, Pipeline Overhead
<i>at least one of</i>	for Land Region, Marine Farm/Culture, Obstruction, Restricted Area Regulatory, Sea Area/Named Water Area, Wreck, Non-Standard Working Day
<i>if navigable at....</i>	for Gate
<i>except when.....</i>	for Traffic Separation Scheme Lane Part
<i>(point features only)</i>	for Radio Calling-in Point
<i>one of</i>	for Text Placement

Compilers must consider these conditional circumstances when encoding features for ENC, as well as any additional information given in the feature class descriptions in this document. For example, when encoding a **Restricted Area Regulatory**, the mandatory attributes are *at least one of* **category of restricted area** or **restriction** – if **restriction** is known but **category of restricted area** is not known, then **category of restricted area** must not be populated with an empty (null) value, as it is not mandatory in this case.

NOTE 2: For complex attributes, at least one sub-attribute is mandatory (or conditionally mandatory) so as such mandatory sub-attributes of complex attributes have not been included in Table 2.2 above. Where the sub-attribute of a complex is conditionally mandatory (for example, for the feature **Seabed Area** *at least one of* the sub-attributes **nature of surface** or **nature of surface – qualifying terms** must be populated for the complex attribute **surface characteristics**), this is indicated in the Remarks section for the relevant feature Table entries below.

NOTE 3: The attribute **colour pattern** is mandatory for any feature (except lights features) that has more than one value populated for the attribute **colour**.

2.4.4 Missing attribute values

Where a value of a mandatory attribute is not known, the attribute must be populated with an empty (null) value.

Where the value of a non-mandatory attribute is not known, the attribute should not be included in the dataset.

In a base dataset, when an attribute code is present but the attribute value is missing, it means that the producer wishes to indicate that this attribute value is unknown.

In an Update dataset, when an attribute code is present but the attribute value is missing it means:

- that the value of this attribute is to be replaced by an empty (null) value if it was present in the original dataset, or
- that an empty (null) value is to be inserted if the attribute was not present in the original dataset.

2.4.5 Portrayal feature attributes

The primary use of ENC is within ECDIS where ENC data is displayed based on the rules defined within the S-101 Portrayal Catalogue. While most ECDIS portrayal is based on attributes describing the instance of a particular feature in the real world, certain feature attributes are used in portrayal rules to provide additional functionality in the ECDIS or information to the mariner. The following attributes have specific influence on portrayal:

Display name – this Boolean attribute determines if the text for a name should display. If not populated the default rules provided in the portrayal catalogue will be used.

Information – population of this complex attribute will result in the display of the magenta information symbol to highlight additional information to the user.

In the water – this Boolean attribute determines that features that are located in or over navigable water are included in the ECDIS Base Display.

Pictorial representation – population of this attribute will result in the display of the magenta information symbol to highlight additional information to the user.

Scale minimum – value at which the feature will be removed from the display if application of scale minimum is enabled in the ECDIS (see clause X.X).

Visually conspicuous – this Boolean attribute determines that visually conspicuous features are shown in black colour rather than brown.

2.4.6 Textual information

The information class **Nautical Information** (see clause X.X) may be used to encode additional textual information associated to a feature or a group of features. The **Nautical Information** is associated to the relevant features using the association **additional information** (see clause X.X). **Nautical Information** must not be used when it is possible to encode the information by means of any other attribute. Under certain ECDIS display settings the “information” symbol will display when these attributes are populated. Therefore producers should carefully consider use of these attributes as the symbol may contribute significantly to ECDIS screen clutter.

The complex attribute **information** contains information as text using the sub-attribute **text**, or the name of an external file using the sub-attribute **file reference**.

Character strings contained in **information** sub-attribute **text** must be UTF-8 character encoding. **Information** should generally be used for short notes or to transfer information which cannot be encoded by other attributes, or to give more detailed information about a feature. Text populated in **text** must not exceed 300 characters.

The exchange language for textual information should be English, therefore it is not required to populate the sub-attribute **language** for an English version of textual information. Languages other than English may be used as a supplementary option, for which **language** must be populated with an appropriate value to indicate the language. Generally this means, when a national language is used in the textual attributes, the English translation must also exist.

Remarks:

- For Guidance on encoding names of features, see clause X.X.

2.4.7 Spatial attribute types

Spatial attribute types must contain a referenced geometry and may be associated with spatial quality attributes. Each spatial attribute instance must be referenced by a feature instance or another spatial attribute instance.

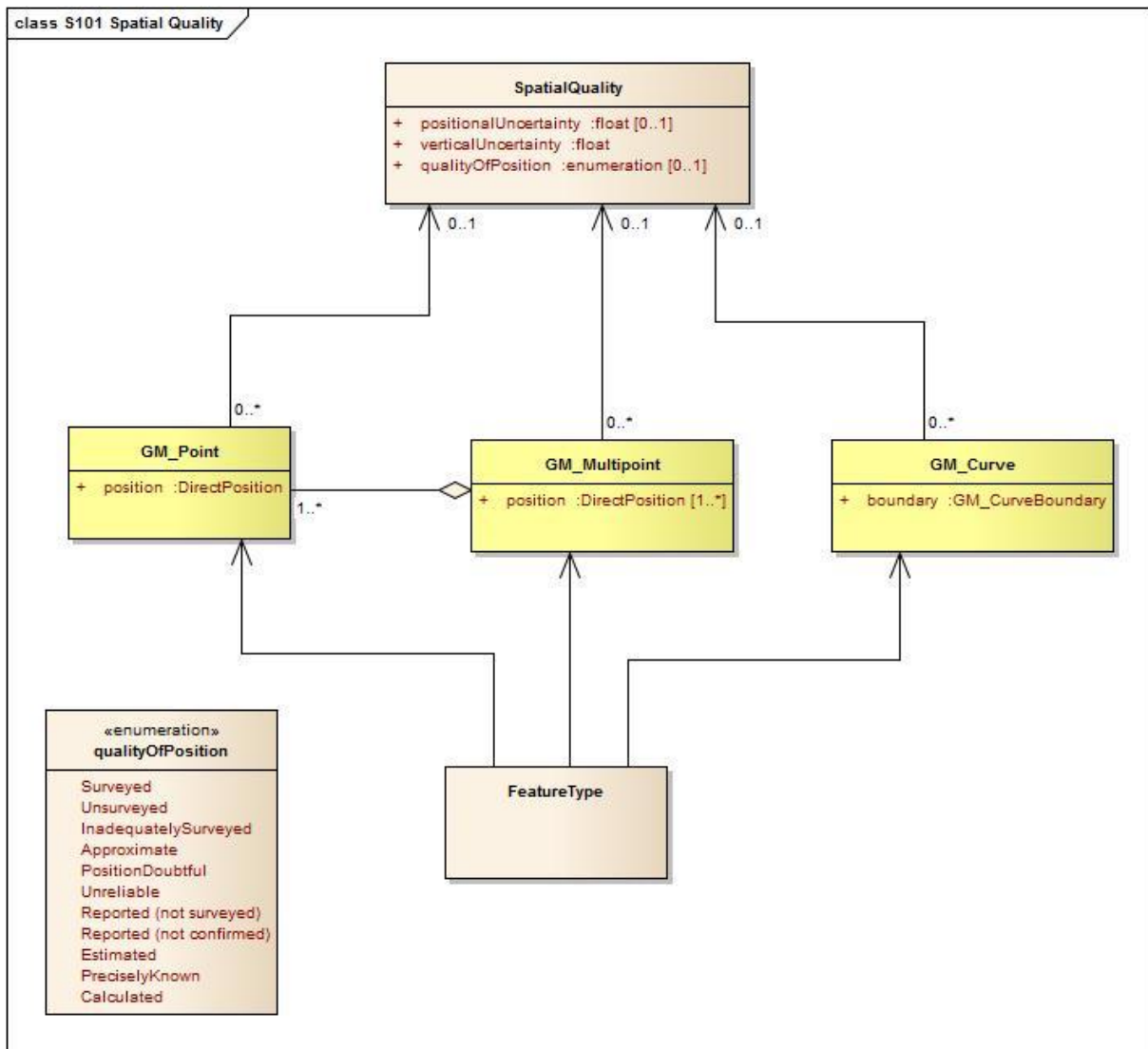

Spatial quality attributes are carried in the information type **Spatial Quality** (see clause X.X). Only points, pointsets and curves can be associated with **Spatial Quality**. Currently no use case for associating surfaces with spatial quality attributes is known, therefore this is prohibited. Vertical uncertainty is prohibited for curves as this dimension is not supported by curves.

2.4.8 Dates

When encoding dates using the attributes **dredged date**, **fixed date range**, **periodic date range**, **reported date**, **survey date range** and **swept date**, and no specific year, month or day is required, the following values must apply in conformance to ISO 8601:2004 and S-100 Part X.

- No specific year required, same day each year: ----MMDD
- No specific year required, same month each year: ----MM--
- No specific day required: YYYYMM--
- No specific month required: YYYY----

Notes: YYYY = calendar year; MM = month; DD = day.
The dashes (-) indicating that the year, month or date is not needed must be included.

2.4.8.1 Seasonal features

If it is required to show seasonality of features, it must be done using the attribute **Status = 5** (periodic/intermittent). If it is required to encode the start and/or end dates of the season, this must be done using the complex attribute **periodic date range**.

2.4.9 Times

If it is required to show the beginning and end of the active time period of a feature, it must be encoded using the attributes **time of day end** (see clause X.X) and **time of day start** (see clause X.X). The attribute descriptions for **time of day end** and **time of day start** state that the mandatory format is hhmss, and this format must be used.

2.4.9.1 Schedules

If it is required to indicate the time schedule associated with any feature, it must be encoded using the information classes **Service Hours** (see clause X.X) or **Non-Standard Working Day** (see clause X.X). **Service Hours** is used to indicate the regular operational schedule and/or times of closure for a service related to a feature. **Non-Standard Working Day** is used to indicate specific days of the year when normal working hours are limited, and may not be related to the Gregorian calendar.

EXAMPLE: A feature service is available under normal operation status 24 hours/day on Monday and Wednesday and from 08:00 to 16:00 (local time) from Thursday to Saturday. The service is not available on public holidays and the 05 of August of each year.

Service Hours

schedule by day of week

category of schedule = 1 (normal operation)

time intervals by day of week

day of week = 1,3 (Monday, Wednesday)

day of week is range = 0 (false)

time intervals by day of week

day of week = 4,6 (Thursday, Saturday)

day of week is range = 1 (true)

time of day start = 080000

time of day end = 160000

time reference = 2 (local time)

Non-Standard Working Day

date fixed = - - - -0805 (05 August each year)

date variable = *public holidays*

2.4.10 Colours and colour patterns

If it is required to encode multiple colours on a feature, they must be encoded using the attributes **colour pattern** and **colour** as follows:

- For horizontal stripes (**colour pattern** = 1), the values for **colour** must be ordered such that the first colour is the top-most, and subsequent colours follow sequentially from top to bottom. For example, **colour** = 3,1 to encode a red stripe above a white stripe.
- For vertical stripes (**colour pattern** = 2), the values for **colour** must be ordered such that the first colour is the left-most, and subsequent colours follow sequentially from left to right. For example, **colour** = 3,1,3 to encode red, white, red vertical stripes
- For diagonal stripes (**colour pattern** = 3), the values for **colour** must be ordered such that the first colour is the top-left-most, and subsequent colours follow sequentially from top left to bottom right. For example, **colour** = 1,3,1,3,1 to encode white, red, white, red, white diagonal stripes.
- For squares (**colour pattern** = 4), the values for **colour** must be ordered such that the first colour is the top-left-most square. Subsequent colours follow sequentially from left to right along the top row then repeated for subsequent rows until the bottom right-most square is reached. For example, **colour** = 1,3,3,1 to encode white, red squares on the top row and red, white squares on the bottom row.
- For border stripes (**colour pattern** = 6), the values for **colour** must be ordered such that the first colour is the border stripe, and the second colour that of the background. For example, **colour** = 3,1 to encode a red border stripe on a white background. Where a border stripe is combined with other patterns, an assessment as to which pattern is most important to marine navigation must be made, and the appropriate value populated in **colour pattern**.

Note that the attribute **colour pattern** is mandatory for any feature (except lights) that has more than one colour.

2.4.11 Radar conspicuous features (see S-4 – B-485.2)

The attribute **radar conspicuous** is used to encode whether or not a feature is radar conspicuous.

Remarks:

- If it is required to encode a feature which has no radar reflector, but is radar conspicuous, it must be indicated using attribute **radar conspicuous**.
- If it is required to encode a surface or point feature which is radar conspicuous because it is fitted with a radar reflector, it must be indicated using attribute **radar conspicuous** on the feature.
- If it is required to encode radar reflectors on curve features (for example overhead cables), this must be done using the feature **Radar Reflector** (see clause X.X).

2.4.12 Attributes referencing external files

2.4.12.1 Reference to textual files

The information class **Nautical Information**, complex attribute **information** must not be used when it is possible to encode the information by means of any other attribute. Under certain ECDIS display settings the “information” symbol will display when this attribute is populated. Therefore producers should carefully consider use of this attribute as the symbol may contribute significantly to ECDIS screen clutter.

The files referenced by **information** sub-attribute **file reference** must be .TXT, .HTM or .XML files, and may contain formatted text. These files should generally be used for longer texts (for example longer chart notes, tables or paragraphs from nautical publications), but should not be used to replicate large blocks of text (for example entire chapters of Sailing Directions) that can be found in other Nautical Publications, which may not be suitable for viewing in ECDIS. It is up to the Producing Authority to determine the most suitable means of encoding a particular piece of text. Files must only use UTF-8 character encoding.

The exchange language for textual information should be English. The sub-attribute **language** must be populated with an appropriate value to indicate the language used. Languages other than English may be used as a supplementary option. Generally this means, when a national language is used in the textual attributes, the English translation must also exist.

Remarks:

- Clause X.X of the S-101 ENC Product Specification main document specifies the content of an ENC exchange set, including the option to include textual files.
- In some cases, for external files referenced by the attribute **information** with sub-attribute **language** populated as a language other than English, encoders have created text files using local character encoding that may not be interpreted correctly by an ECDIS and therefore not readable by the user. Encoders must encode national text files (files referenced by the sub-attribute **file reference**) using UTF-8 character encoding. This means that the encoding of the characters in text files must match the encoding of other textual national attributes (that is, **feature name**, **information (text)** with value other than English populated for sub-attribute **language**) within the dataset.

2.4.12.2 Reference to pictorial files

If it is required to indicate a drawing or a photograph, the information class **Nautical Information** (see clause X.X), attribute **pictorial representation** must be used to indicate the file name (without the path) of the external graphical file. The **Nautical Information** is associated to the relevant feature using the association **additional information** (see clause X.X). Picture files that form part of the ENC can be in Tagged Image File (TIF) format 6.0 or in PDF format.

Consideration should be given to the addition of the “information” symbol in some ECDIS display settings where **pictorial representation** is populated, which may contribute to ECDIS screen clutter. **Pictorial representation** should therefore only be populated where the information is considered important in terms of safety of navigation and protection of the marine environment.

Encoders should also consider, when including a reference to an external graphics file, whether the file is appropriate in terms of:

- Size of the file: Graphics files should be kept to a minimum file size, and should be considered in relation to the maximum allowable size of an ENC dataset (10Mb). Therefore, for example, a graphic file of 100Mb should be considered to be inappropriate. Using the following values as a guideline for TIF files will ensure acceptable size files:

Recommended Resolution:	96 DPI
Minimum Size x,y:	200,200 pixels
Maximum Size x,y:	800,800 pixels
Bit Depth:	8 Bit Indexed Colour
Compression:	LZW
Format:	Tiff 6.0

- Content of the graphic: The information contained in the graphic should supplement, in terms of navigational relevance, the encoding of the associated feature. For example, an image of a standard IALA special purpose buoy that duplicates the attribution of the associated **Buoy Special Purpose/General** provides no relevant supplementary information to the mariner (and may be considered to be double encoding), and therefore should not be included.
- Aspect: Graphics should provide perspective relevant to the view of the mariner. For example, an image of the top of a bridge derived from a photograph taken from the top of a bridge tower or nearby building does not provide the mariner with any information relevant to their location, and should not be included. However, an image derived from a photograph taken from a vessel approaching the bridge may be considered relevant.
- Suitability for display in ECDIS: Graphics should be such that all the information in the graphic is legible in the ECDIS display. For example, text included in diagrams or tables must be large enough so as to be legible when the file is opened in the ECDIS display. Images included in a graphical file should also be appropriately scaled such that they comfortably fit in the picture display window on the ECDIS (that is, do not only take up a very small area of the window; or are so large that the image needs to be panned to see the entire image). Consideration must also be given to variation in ships' bridge lighting conditions. It is recommended that, where possible, associated files are tested by opening the file in an ECDIS prior to publication of the ENC.

2.5 Datasets

A Dataset is a grouping of features, attributes, geometry and metadata which comprises a specific coverage.

Four types of ENC dataset may be produced and contained within an exchange set:

- Update: Changing some information in an existing dataset.
- Re-issue of a dataset: Including all the Updates applied to the original dataset up to the date of the reissue. A Re-issue does not contain any new information additional to that previously issued by Updates.
- New dataset and New Edition of a dataset: Including new information which has not been previously distributed by Updates. Each New Edition of a dataset must have the same name as the dataset that it replaces.

2.5.1 ENC data coverage

An ENC dataset can contain more than one **Data Coverage** (see clause X.X). The data boundary is defined by the extent of the **Data Coverage** meta features. Data must only be present within **Data Coverage** meta features.

Producing Authorities should not leave "holes" (that is, areas not covered with data) in smaller scale range coverage, under the assumption that the ECDIS user will have the larger scale data available.

When a feature extends across datasets of overlapping scale ranges, its geometry must be split at the boundaries of the **Data Coverage** features and its complete attribute description must be repeated in each dataset.

An ENC Update dataset must not change the extent of the data coverage for the base ENC cell. Where the extent of the data coverage for a base ENC cell is to be changed, this must be done by issuing a New Edition of the cell.

2.5.2 Discovery metadata

The discovery metadata classes have numerous attributes which enable important information about the datasets and accompanying support files to be examined without the need to process the data, for example, decrypt, decompress, load etc.

S101_DatasetDiscoveryMetadata	
+	fileName :CharacterString
+	filePath :CharacterString
+	description :CharacterString
+	dataProtection :Boolean [0..1]
+	protectionScheme :CharacterString [0..1]
+	digitalSignature :CharacterString
+	copyright :MD_RestrictionCode [0..1]
+	classification :MD_SecurityConstraints [0..1]
+	purpose :CharacterString
+	specificUsage :MD_Usage
+	editionNumber :CharacterString
+	updateNumber :CharacterString
+	updateApplicationDate :Date [0..1]
+	issueDate :Date
+	productSpecification :S100_ProductSpecification
+	producingAgency :CI_ResponsibleParty
+	maximumDisplayScale :Integer [0..1]
+	horizontalDatumReference :CharacterString
+	horizontalDatumValue :Integer
+	verticalDatum :S100_VerticalAndSoundingDatum
+	soundingDatum :S100_VerticalAndSoundingDatum
+	dataType :S100_DataFormat
+	otherDataTypeDescription :CharacterString [0..1]
+	dataTypeVersion :CharacterString
+	dataCoverage :S100_DataCoverage [1..*]
+	comment :CharacterString [0..1]

Further information regarding discovery metadata can be found in the S-101 Main document.

2.5.3 Minimal depiction areas

Where minimal depiction areas exist in a specified ENC maximum display scale, they should be encoded using one of the following options:

2.5.3.1 Wide blank areas

Areas of a dataset which contain no data must be excluded from the area(s) covered by the meta feature **Data Coverage**. The areas that contain data must be completely covered by **Data Coverage** features.

2.5.3.2 Simplified or minimum depiction areas

- Bathymetry in such areas should be encoded as described in clause X.X.
- Information that does not relate to bathymetry but is relevant to land area features may be encoded.
- One **Caution Area** feature covering the whole area should be created. The complex attributes **information** (sub-attribute **text** or **file reference**) on an associated instance of the information class **Nautical Information** (see clause X.X) should be encoded using one of the following options (the textual content of the attributes (for **file reference** this will be the contents of the referenced file) is within quotation marks and italicised):

Where larger scale coverage is available:

“Most features, including bathymetry, are omitted in this area. The minimal depiction of detail in this area does not support safe navigation; mariners should use a more appropriate scale ENC.”

Any other relevant information pertaining to the area should be incorporated within, or replace completely, the above statement.

Where no larger scale coverage is available:

“Most features, including bathymetry, are omitted in this area. The minimal depiction of detail in this area does not support safe navigation.”

This statement should be supplemented by additional cautionary information relating to any authority to be consulted before navigating in the area.

2.5.4 Dataset attributes

Dataset attributes contain metadata that apply to the whole dataset. Some attributes have designated ISO 8211 encoding subfields; other attributes use the ATTR subfield. See table below for details.

[Insert table with all dataset attributes]

2.5.5 Units

The depth, height and positional uncertainty units in a dataset must be metres.

2.5.6 Coordinate multiplication factor

The coordinate multiplication factor stored in the CMFX and CMFY subfield values in the Dataset Structure Information field must be set to *10000000* (10^7) for all datasets.

EXAMPLE: A longitude = 42.0000 is converted into $X = \text{longitude} * \text{CMFX} = 42.0000 * 10000000 = 420000000$.

2.5.7 Seamless ENC coverage

ENCs should form a seamless coverage in the navigable waters of the producer's area of responsibility. However, it is often impractical to do so in all radar range scales, and therefore S-101 ENCs declare a scale range, which dictate between what scales the data can be used.

The meta feature **Data Coverage** (see clause X.X) is used to provide the ECDIS with the scale information necessary for the determination of dataset loading and unloading in relation to the user selected viewing scale in the ECDIS.

The mandatory attribute **maximum display scale** is used to indicate the largest intended viewing scale for the data. The mandatory attribute **minimum display scale** is used to indicate the smallest intended viewing scale for the data.

An ENC dataset (discovery metadata) and associated **Data Coverage** feature(s) must carry a value for maximum display scale. Each **Data Coverage** feature must also carry a value for minimum display scale. Values must be taken from the following table:

Scale
1:10,000,000
1:3,500,000
1:1,500,000
1:700,000
1:350,000
1:180,000
1:90,000
1:45,000
1:22,000
1:12,000
1:8,000
1:4,000

1:3,000
1:2,000
1:1,000

All data within a dataset must have the same minimum display scale, but portions of a dataset can have a different maximum display scale, depending on the best scale required for navigation in an area for the purpose of the ENC data.

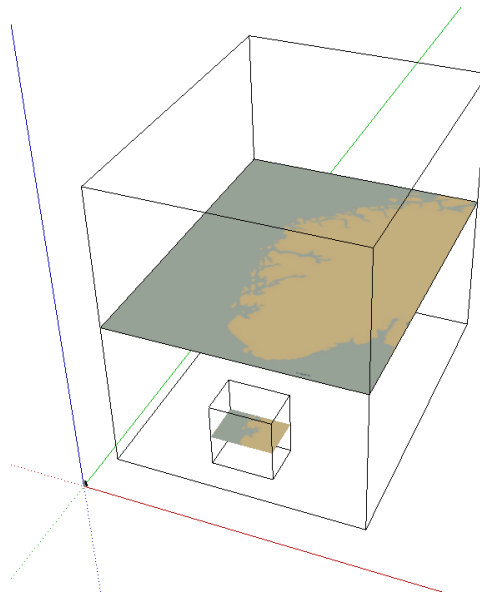

Example of scale ranges

There must be no gaps in data between adjoining datasets if they share the same scale range in part or in full. Similarly, there must be no overlapping data between datasets if they share same scale range in part or in full, except at the agreed adjoining producer data limits, where, if it is difficult to achieve a perfect join, a 5 metre overlapping buffer zone may be used.

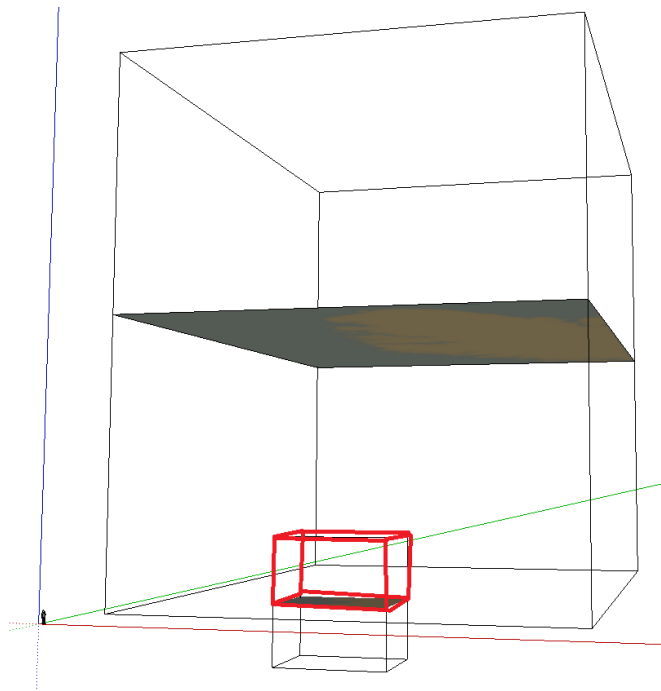

Example of scale range overlap. The red box indicates an overlap between the scale range of two datasets, which is not permitted.

To ensure a seamless ECDIS display of ENC data within the same scale range, it is important that the data on the border of the dataset is aligned and matched with the corresponding data in any adjoining datasets within the scale range, where possible. Where there is a mismatch in depth data between adjoining datasets, editing of the depth data should be done such that depth contours and depth areas are adjusted on the side of safety. Edge matching of data across different scale ranges, particularly depth data, is often not possible due to generalisation issues resulting from differing scales, although features such as maritime boundaries, navigation lines, recommended tracks, roads etc. should be edge matched where possible. Note that point or curve features which are at the border of **Data Coverage** (see clause X.X) features for adjoining cells with the same scale range must be part of only one dataset.

In areas which include neighbouring producer nations, Hydrographic Offices should co-operate to agree on dataset boundaries and ensure no data overlap within scale ranges. Where possible, adjoining nations should agree on common data boundaries within a technical arrangement based on cartographic convenience and benefit to the mariner. Suitable communications between neighbouring nations should be put in place to ensure data consistency across dataset boundaries. These should include exchange mechanisms to allow access to each other's ENCs.

2.5.8 Feature Object Identifiers

Each feature and information instance within an ENC must have a unique universal Feature Object Identifier [FOID]. Where a real-world feature has multiple geometric elements within a single ENC dataset due to the ENC dataset scheme, the same FOID may be used to identify multiple instances of the same feature. Features within a dataset may carry multiple geometries.

Data converted from S-57 may contain the same feature in multiple feature instances. Where this occurs, all these feature instances must be identical; that is, same feature class and attribute values.

Features split across multiple datasets may be identified by the same FOID. Features repeated in different scale ranges may be identified by the same FOID.

Feature Object Identifiers must not be reused, even when a feature has been deleted.

2.5.9 180° Meridian of Longitude

Datasets must not cross the 180° meridian of longitude.

2.5.10 Heights and elevations

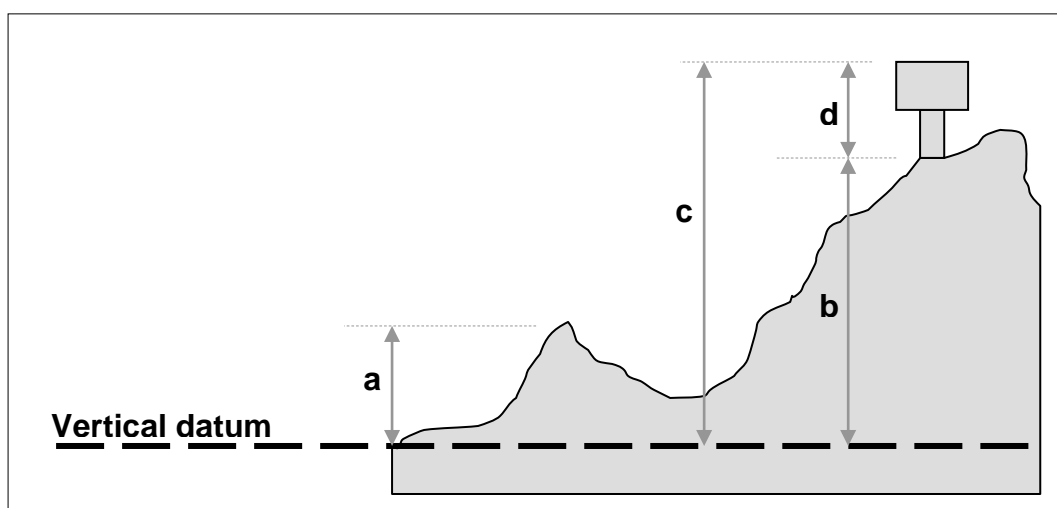

If it is required to encode the altitude of natural features above a vertical datum (for example hills, coastlines, slopes), with the exception of trees, it must be done using the attribute **elevation** (figure (a)).

For artificial features (for example landmarks, buildings) or trees:

- If it is required to encode the altitude of the ground level at the base of the feature, or the elevation of a light, above a vertical datum, it must be done using **elevation** (figure (b)).
- If it is required to encode the altitude of the highest point of the feature above a vertical datum, it must be done using the attribute **height** (figure (c)).
- If it is required to encode the height of the feature above ground level or the seabed (that is, not associated with a vertical datum), it must be done using the attribute **vertical length** (figure (d)).

2.5.11 Geographic names

If it is required to encode an international or national geographic name, it must be done using complex attribute **feature name** (see clause X.X). When possible, existing features (for example **Built-Up Area**, **River**, navigational marks) should be used to carry this information.

If it is required to encode a geographic name for which there is no existing feature, a specific **Administration Area**, **Sea Area/Named Water Area** or **Land Region** feature must be created (see clauses X.X, X.X and X.X). In order to minimise the data volume, these features should, where possible, use the geometry of existing features, for example a **Sea Area/Named Water Area** feature may use the geometry of a **Depth Area** feature.

National geographic names can be left in their original national language in a non-English iteration of the sub-attribute **feature name** (but only if the national language can be expressed using lexical level 0 or 1), or transliterated or transcribed and used in an English iteration of the sub-attribute **feature name**, in which case the national name should be populated in an additional iteration of the **feature name** with sub-attribute **language** populated with the relevant national language value in accordance with ISO 639-3.

Geographic names should be encoded using **feature name** based on the following criteria and at the Producing Authority's discretion:

1. Named points or capes that do not contain navigational aids should be encoded as **Land Region** features (of type surface or point), with the geographic name encoded using **feature name**.
2. Named points or capes that contain one navigational aid should be encoded using **feature name** on the structure feature associated with the navigational aid. If more than one navigational aid exists on the point or cape or if the point or cape and the structure feature have different names, a **Land Region** feature (of type surface or point) should be encoded, with the geographic name of the point or cape encoded using **feature name**.
3. A group of hydrographic features (for example **Seabed Area**, **Underwater/Awash Rock**, **Obstruction**), associated with a particular geographic name, should have the name encoded using **feature name** on a **Sea Area/Named Water Area** feature (of type surface or point). The name should not be encoded on the individual hydrographic features.
4. A major island name close to primary shipping corridors should be encoded using **feature name** on the **Land Area** feature delimiting the island. A group of islands associated with a geographic name should have the name encoded using **feature name** on a **Land Region** feature (of type surface or point).
5. A named island group or archipelago should be encoded using **feature name** on an **Island Group** named aggregation feature (see clause X.X). Where individual islands within the group are named, these should be encoded using **feature name** on the **Land Area** feature delimiting the island.
6. Named features listed in Hydrographic Office's Sailing Directions that may assist in navigation should be encoded using **feature name** on the relevant feature (for example **Land Region**, **Underwater/Awash Rock**, **Seabed Area**, **Sea Area/Named Water Area**, **Obstruction**).
7. If it is required to encode an administrative area of international, national, provincial or municipal jurisdiction that may have legal inference, it must be done using an **Administration Area** feature, with the name encoded using **feature name**.
8. If it is required to encode a major city along the coast, it must be done using **Built-Up Area** or **Administration Area** features (see clause X.X), with the name encoded using **feature name**.

9. If it is required to encode the name of a navigable river, lake or canal, it must be done using a **Sea Area/Named Water Area** feature, with the name encoded using **feature name**.

In all instances, if the exact extent of the feature to be named is known, a surface feature must be created. If the exact extent is not known, or the area is too small at the maximum display scale of the ENC dataset, an existing or specifically encoded point feature should be used to encode the geographic name.

2.5.11.1 Text placement

The cartographic feature **Text Placement** (see clause X.X) is used specifically to place text cartographically. The properties of the text placement feature are described as follows;

Geometry (point) – the spatial point location of the centre of the text string.

Text type – the attribute (or class) which is to be placed.

Flip bearing – the angle forming a semi-circle within which the text can be placed.

The **Text Placement** feature is associated to the feature which carries the text being placed. The attribute **text type** determines which text string is to be displayed if more than one is present. The **Text Placement** feature ensures that as an ECDIS screen rotates from “north up” (for example, if display is set to “course up”) text can remain readable, or clear other important charted information.

2.5.12 Sample scale minimum policy

The following policy for the application of **scale minimum** (see clause X.X) to an ENC portfolio is based on the mandatory ENC cell compilation scales listed in clause X.X. While the procedure described below to determine the **scale minimum** value for features in an ENC cell is recommended, the **scale minimum** values used are at the discretion of the Producing Authority. Authorities should cooperate at the regional or RENC level to determine a **scale minimum** policy that results in suitable and consistent display of ENC data for the mariner across and, where required between, regions.

Scale minimum values used must be selected from the following list:

19999999
9999999
4999999
3499999
1499999
999999
699999
499999
349999
259999
179999
119999
89999
59999
44999
29999
21999
17999
11999
7999
3999

2999
1999
999

- **scale minimum** values for features within an ENC should be set to either 1, 2, 3 or 4 steps smaller scale than the maximum display scale of the ENC data.
- The table below lists the step values (that is 1, 2, 3 or 4) that may be applied for specific feature classes together with any relevant conditions and additional flexibilities.

Following this process provides an automated approach to setting **scale minimum** which takes account of the relative importance of different feature classes, and will achieve sufficient de-cluttering even where there are large gaps in the scales of coverage available.

Unless the step values outlined in the table have been manually adjusted, this approach takes no direct account of the relative importance of individual occurrences of a feature, and may result in the situation where a feature disappears and then reappears as the user zooms out on their ECDIS display. To address these remaining issues, the following additional process steps should be applied:

- Linear and area features (excluding those features subject to extensive generalisation for example **Depth Contour**) that extend beyond the coverage of a dataset and exist in an overlapping smaller scale dataset should be assigned the same **scale minimum** value as the **scale minimum** value of the corresponding feature in the smaller scale dataset.
- The **scale minimum** value of an individual occurrence of a feature should be set to either 1, 2, 3 or 4 steps smaller scale than the compilation scale of the smallest scale ENC that the feature would appear on (that is, assuming full coverage across all compilation scales).

The following notes apply to the table below:

1. Producers should be prepared to deviate from the step values specified when the significance of the feature dictates, for example the recommended number of steps for a **Light** feature is 4, but there will be circumstances where a **Light** feature is so important that no **scale minimum** value be applied; alternatively, the light could be so minor that a step value of 1 can be applied.
2. **Scale minimum** should only be applied to navigational aids where they contribute to “screen clutter” and where their removal from the display does not constitute a risk to safe navigation.
3. It is generally accepted that features making up a navigational aid will have the same attributes, and therefore those with Master/Slave relationships should be assigned the same **scale minimum** value.
4. The elements comprising a range system (see clause X.X.X) must have the same **scale minimum** value, which should be the value corresponding to the largest step value of the features comprising the range system. For instance, for a range system comprising a **Navigation Line**, **Recommended Track** and navigation aids, the decision may be not to apply **scale minimum** to the navigation aids (in accordance to Note 2 above), in which case the **Navigation Line** and **Recommended Track** must also not have **scale minimum** applied. Similarly, all features comprising a routeing measure (see clause 10.2) should have the same **scale minimum** value.

FEATURE	PRIMITIVE	CONDITION	scale minimum STEPS
Administration Area	Surface		3
Anchorage Area	Point/Surface		2
Anchor Berth	Point/Surface	If restriction defined	3
Anchor Berth	Point/Surface		1
Airport/Airfield	Point/Surface	If visually conspicuous = 1 (visually conspicuous)	3
Airport/Airfield	Point/Surface		1
Archipelagic Sea Lane Area	Surface		4
Archipelagic Sea Lane Axis	Curve		4

FEATURE	PRIMITIVE	CONDITION	scale minimum STEPS
Beacon Cardinal	Point		3 (see Notes 2, 3 & 4 above)
Beacon Isolated Danger	Point		4 (see Notes 2, 3 & 4 above)
Beacon Lateral	Point		3 (see Notes 2, 3 & 4 above)
Beacon Safe Water	Point		3 (see Notes 2, 3 & 4 above)
Beacon Special Purpose/General	Point		3 (see Notes 2, 3 & 4 above)
Berth	Point/Curve/Surface		1
Bridge	Point/Curve/Surface	Covered by an surface Depth Area , Dredged Area , or Unsurveyed Area feature	4
Bridge	Point/Curve/Surface	If visually conspicuous = 1 (visually conspicuous) or radar conspicuous = <i>True</i> and covered by a surface Land Area , Dock Area , or Lock Basin feature	3
Bridge	Point/Curve/Surface		1
Buoy Cardinal	Point		3 (see Notes 2, 3 & 4 above)
Buoy Emergency Wreck Marking	Point		3 (see Notes 2, 3 & 4 above)
Buoy Installation	Point		3 (see Notes 2, 3 & 4 above)
Buoy Isolated Danger	Point		4 (see Notes 2, 3 & 4 above)
Buoy Lateral	Point		3 (see Notes 2, 3 & 4 above)
Buoy Safe Water	Point		3 (see Notes 2, 3 & 4 above)
Buoy Special Purpose/General	Point		3 (see Notes 2, 3 & 4 above)
Building	Point/Surface	If visually conspicuous = 1 (visually conspicuous) or radar conspicuous = <i>True</i> or function = 33 (light support)	3
Building	Point/Surface		1
Built-up Area	Point/Surface	If visually conspicuous = 1 (visually conspicuous) or radar conspicuous = <i>True</i>	3
Built-up Area	Point/Surface		1
Cable Area	Surface	If restriction defined	3
Cable Area	Surface		2
Cable Overhead	Curve	Covered by an area Depth Area , Dredged Area , or Unsurveyed Area feature	4
Cable Overhead	Curve	If visually conspicuous = 1 (visually conspicuous) or radar conspicuous = <i>True</i>	3
Cable Overhead	Curve		1
Cable Submarine	Curve		3
Canal	Curve		1
Canal	Surface		4
Cargo Transshipment Area	Point/Surface		1
Causeway	Curve/Surface		2

FEATURE	PRIMITIVE	CONDITION	scale minimum STEPS
Caution Area	Point/Surface		4
Checkpoint	Point/Surface		1
Coastline	Curve		NOT SET
Coastguard Station	Point		1
Collision Regulations Limit	Curve		4
Contiguous Zone	Surface		3
Continental Shelf Area	Surface		3
Conveyor	Curve/Surface	Covered by an surface Depth Area , Dredged Area , or Unsurveyed Area feature	4
Conveyor	Curve/Surface	If visually conspicuous = 1 (visually conspicuous) or radar conspicuous = <i>True</i>	3
Conveyor	Curve/Surface		1
Crane	Point/Surface	If visually conspicuous = 1 (visually conspicuous) or radar conspicuous = <i>True</i>	3
Crane	Point/Surface		1
Current – Non-navigational	Point		3
Custom Zone	Surface		2
Dam	Curve/Surface	If seaward edge is coincident with the coastline (see clause X.X)	NOT SET
Dam	Curve/Surface	If visually conspicuous = 1 (visually conspicuous) or radar conspicuous = <i>True</i>	3
Dam	Curve/Surface		1
Daymark	Point	If Slave scale minimum must match that of Master	3
Deep Water Route Centreline	Curve		NOT SET
Deep Water Route Part	Surface		NOT SET
Depth Contour	Curve	If value of depth contour = 0 (drying line) or 30	4
Depth Contour	Curve		2
Depth – No Bottom Found	Point		1
Discoloured Water	Point/Surface		NOT SET
Distance Mark	Point		2
Dry Dock	Surface		1
Dumping Ground	Point/Surface	If restriction defined	3
Dumping Ground	Point/Surface		2
Dyke	Curve/Surface	If seaward edge is coincident with the coastline (see clause X.X)	NOT SET
Dyke	Curve/Surface		1
Exclusive Economic Zone	Surface		3
Fairway	Surface		3
Fence/Wall	Curve	If visually conspicuous = 1 (visually conspicuous) or radar conspicuous = <i>True</i>	3
Fence/Wall	Curve		1
Ferry Route	Curve/Surface		3
Fishery Zone	Surface		3
Fishing Facility	Point/Curve/Surface		2

FEATURE	PRIMITIVE	CONDITION	scale minimum STEPS
Fishing Ground	Surface		1
Floating Dock	Point/Curve	If visually conspicuous = 1 (visually conspicuous) or radar conspicuous = <i>True</i>	3
Floating Dock	Point/Curve		2
Floating Dock	Surface		NOT SET
Fog Signal	Point	If Slave scale minimum must match that of Master	3
Fortified Structure	Point/Curve/Surface	If visually conspicuous = 1 (visually conspicuous) or radar conspicuous = <i>True</i>	3
Fortified Structure	Point/Curve/Surface		1
Foul Ground	Point/Curve/Surface	If value of sounding > 30 and exposition of sounding ≠ 2 (shoaler than range of the surrounding depth area)	4
Foul Ground	Point/Curve/Surface		NOT SET
Free Port Area	Surface		2
Gate	Point/Curve/Surface	Covered by an surface Depth Area , Dredged Area , or Unsurveyed Area feature	NOT SET
Gate	Point/Curve/Surface		2
Gridiron	Point/Surface		1
Harbour Area (Administrative)	Surface		3
Harbour Facility	Point/Surface		1
Hulk	Point	If visually conspicuous = 1 (visually conspicuous) or radar conspicuous = <i>True</i>	3
Hulk	Point		1
Hulk	Surface		NOT SET
Ice Area	Surface		3
Information Area	Point/Curve/Surface		2
Inshore Traffic Zone	Surface		NOT SET
Lake	Surface		1
Land Area	Point/Curve/Surface		NOT SET
Land Elevation	Point	If visually conspicuous = 1 (visually conspicuous)	3
Land Elevation	Point/Curve		1
Land Region	Point/Surface		1
Landmark	Point/Curve/Surface	If visually conspicuous = 1 (visually conspicuous) or radar conspicuous = <i>True</i> or function = 33 (light support)	3
Landmark	Point/Curve/Surface		1
Light Air Obstruction	Point	If Slave scale minimum must match that of Master	4 (see Notes 2, 3 & 4 above)
Light All Around	Point	If Slave scale minimum must match that of Master	4 (see Notes 2, 3 & 4 above)
Light Fog Detector	Point	If Slave scale minimum must match that of Master	4 (see Notes 2, 3 & 4 above)
Light Float	Point		4 (see Notes 2, 3 & 4 above)
Light Sectored	Point	If Slave scale minimum must match that of Master	4 (see Notes 2, 3 & 4 above)

FEATURE	PRIMITIVE	CONDITION	scale minimum STEPS
Light Vessel	Point		4 (see Notes 2, 3 & 4 above)
Local Magnetic Anomaly	Point/Curve/Surface		3
Log Pond	Point/Surface	Covered by a surface Depth Area , Dredged Area , or Unsurveyed Area feature	4
Log Pond	Point/Surface		1
Magnetic Variation	Point/Curve/Surface		1
Marine Farm/Culture	Point/Curve/Surface	If exposition of sounding = 2 (shoaler than range of the surrounding depth area) and value of sounding ≤ 30	4
Marine Farm/Culture	Point/Curve/Surface	If restriction defined	3
Marine Farm/Culture	Point/Curve/Surface		1
Military Practice Area	Point/Surface		3
Mooring/Warping Facility	Point/Curve/Surface	If visually conspicuous = 1 (visually conspicuous) or radar conspicuous = <i>True</i>	3
Mooring/Warping Facility	Point/Curve/Surface		2
Navigation Line	Curve		3
Obstruction	Point/Curve/Surface		NOT SET
Obstruction	Point/Curve/Surface	If value of sounding > 30 and exposition of sounding ≠ 2 (shoaler than range of the surrounding depth area)	4
Offshore Platform	Point/Surface	Covered by a surface Offshore Production Area	3
Offshore Platform	Point/Surface		4
Offshore Production Area	Surface		4
Oil Barrier	Curve		4
Physical AIS Aid to Navigation	Point		3 (see Notes 2, 3 & 4 above)
Pile	Point	Where used to mark position of Light feature in water	4 (see Notes 3 & 4 above)
Pile	Point/Curve/Surface	If visually conspicuous = 1 (visually conspicuous)	3
Pile	Point/Curve/Surface		2
Pilotage District	Surface		3
Pilot Boarding Place	Point/Surface		3
Pipeline Overhead	Curve	Covered by a surface Depth Area , Dredged Area , or Unsurveyed Area feature	4
Pipeline Overhead	Curve	If visually conspicuous = 1 (visually conspicuous) or radar conspicuous = <i>True</i>	3
Pipeline Overhead	Curve		1
Pipeline Submarine/On Land	Point/Curve	Covered by a surface Depth Area , Dredged Area , or Unsurveyed Area feature	3
Pipeline Submarine/On Land	Point/Curve		1
Pontoon	Point/Curve	If visually conspicuous = 1 (visually conspicuous) or radar conspicuous = <i>True</i>	3
Pontoon	Point/Curve		2
Pontoon	Surface		4
Precautionary Area	Point/Surface		NOT SET

FEATURE	PRIMITIVE	CONDITION	scale minimum STEPS
Production/Storage Area	Point/Surface	If visually conspicuous = 1 (visually conspicuous) or radar conspicuous = <i>True</i>	3
Production/Storage Area	Point/Surface		1
Pylon/Bridge Support	Point/Surface	Covered by a surface Depth Area , Dredged Area , or Unsurveyed Area feature	NOT SET
Pylon/Bridge Support	Point/Surface	If visually conspicuous = 1 (visually conspicuous) or radar conspicuous = <i>True</i>	3
Pylon/Bridge Support	Point/Surface		1
Radar Line	Curve		3
Radar Range	Surface		3
Radar Reflector	Point	If Slave scale minimum must match that of Master	3
Radar Station	Point	If Slave scale minimum must match that of Master	2
Radar Transponder Beacon	Point	If Slave scale minimum must match that of Master	3
Radio Calling-in Point	Point/Curve		3
Radio Station	Point	If Slave scale minimum must match that of Master	1
Railway	Curve		1
Rapids	Point/Curve/Surface		1
Recommended Route Centreline	Curve		3
Recommended Track	Curve/Surface		3
Recommended Traffic Lane Part	Point/Surface		3
Rescue Station	Point		3
Restricted Area Navigational	Surface		3
Restricted Area Regulatory	Surface		3
Retroreflector	Point	If Slave scale minimum must match that of Master	3
River	Curve		1
River	Surface		4
Road	Point/Curve/Surface		1
Runway	Point/Curve/Surface	If visually conspicuous = 1 (visually conspicuous)	3
Runway	Point/Curve/Surface		1
Sandwave	Point/Curve/Surface		3
Sea Area/Named Water Area	Point/Surface		1
Seabed Area	Point/Curve/Surface		1
Seaplane Landing Area	Point/Surface	If restriction defined	3
Seaplane Landing Area	Point/Surface		1
Shoreline Construction	Point/Curve/Surface		NOT SET
Signal Station Traffic	Point	If Slave scale minimum must match that of Master	1
Signal Station Warning	Point	If Slave scale minimum must match that of Master	1
Silo/Tank	Point/Surface	If visually conspicuous = 1 (visually conspicuous) or radar conspicuous = <i>True</i>	3
Silo/Tank	Point/Surface		1
Slope Topline	Curve	If visually conspicuous = 1 (visually conspicuous) or radar conspicuous = <i>True</i>	3
Slope Topline	Curve		1

FEATURE	PRIMITIVE	CONDITION	scale minimum STEPS
Sloping Ground	Point/Surface	If visually conspicuous = 1 (visually conspicuous) or radar conspicuous = <i>True</i>	3
Sloping Ground	Point/Surface		1
Small Craft Facility	Point/Surface		1
Sounding	Point		1
Span Fixed	Curve/Surface		NOT SET
Span Opening	Curve/Surface		NOT SET
Spring	Point		1
Straight Territorial Sea Baseline	Curve		3
Submarine Pipeline Area	Point/Surface		3
Submarine Transit Lane	Surface		3
Swept Area	Surface		3
Territorial Sea Area	Surface		3
Tidal Stream – Flood/Ebb	Point/Surface		3
Tidal Stream Panel Data	Point/Surface		2
Tideway	Curve/Surface		1
Traffic Separation Line	Curve/Surface		NOT SET
Traffic Separation Scheme Boundary	Curve		NOT SET
Traffic Separation Scheme Crossing	Surface		NOT SET
Traffic Separation Scheme Lane Part	Surface		NOT SET
Traffic Separation Scheme Roundabout	Surface Area		NOT SET
Traffic Separation Zone	Surface		NOT SET
Tunnel	Curve/Surface	Covered by a surface Depth Area , Dredged Area , or Unsurveyed Area feature	4
Tunnel	Curve/Surface		1
Two-way Route Part	Surface		NOT SET
Underwater/Awash Rock	Point	If value of sounding > 30 and exposition of sounding ≠ 2 (shoaler than range of the surrounding depth area)	4
Underwater/Awash Rock	Point	Covered by an surface Obstruction feature	2
Underwater/Awash Rock	Point		NOT SET
Vegetation	Point/Curve/Surface	If visually conspicuous = 1 (visually conspicuous)	3
Vegetation	Point/Curve/Surface		1
Vessel Traffic Service Area	Surface		3
Virtual AIS Aid to Navigation	Point		3 (see Notes 2, & 4 above)
Water Turbulence	Point/Curve/Surface		3
Waterfall	Point/Curve	If visually conspicuous = 1 (visually conspicuous)	3
Waterfall	Point/Curve		1
Weed/Kelp	Point/Surface		3

FEATURE	PRIMITIVE	CONDITION	scale minimum STEPS
Wind Turbine	Point	On land and if visually conspicuous = 2 (not visually conspicuous) or 3 (prominent)	1
Wind Turbine	Point	Covered by a surface Offshore Production Area	3
Wind Turbine	Point		4
Wreck	Point/Surface	If category of wreck = 1 or (value of sounding > 30 and exposition of sounding ≠ 2 (shoaler than range of the surrounding depth area))	3
Wreck	Point/Surface	If visually conspicuous = 1 (visually conspicuous) or radar conspicuous = <i>True</i>	3
Wreck	Point/Surface		NOT SET
Local Direction of Buoyage	Surface		4
Update Information	Point/Curve/Surface		NOT SET
Text Placement	Point		<= associated feature

Optional additional rules that can be manually applied to fine tune the application of **scale minimum** after the above values have been automatically applied.

FEATURE	PRIMITIVE	CONDITION	scale minimum STEPS
Obstruction	Point	The most significant Obstruction of a group of Obstructions within close proximity	NOT SET
Obstruction	Point	For groups of Obstructions in close proximity, or within an Obstruction surface	2
Sounding	Point	scale minimum should be applied so that the least significant soundings are set to 1 step progressing to 4 steps for the most significant, above the compilation scale in order to achieve a gradual reduction in the soundings displayed as the user zooms out.	1, 2, 3, 4
Depth – No Bottom Found	Point	scale minimum should be applied so that the least significant depths are set to 1 step progressing to 4 steps for the most significant, above the compilation scale in order to achieve a gradual reduction in the depths displayed as the user zooms out.	1, 2, 3, 4
Underwater/Awash Rock	Point	The most significant Underwater/Awash Rock of a group of Underwater/Awash Rocks within close proximity and not within an Obstruction surface	NOT SET
Wreck	Point/Surface	For groups of Wreck in close proximity (the most significant should not have scale minimum)	2

2.5.13 Masking

To improve the look and feel of the display of ENCs in ECDIS for the mariner certain features, or certain edges of features, should be masked (see S-101 clause X.X). For example, the boundaries of anchorage area symbols overwrite coincident pontoon symbols:



Overwriting symbols - example

In order to best determine the appropriate level of masking required for an ENC cell, it is recommended that the ENC be viewed in an ECDIS.

The following scenarios where masking is recommended should be considered by compilers;

1. Surface features crossing ENC cell boundaries:

When a single feature of type surface crosses the boundaries of adjoining ENC cells, mask the edge where it shares the geometry of the boundary in each ENC:

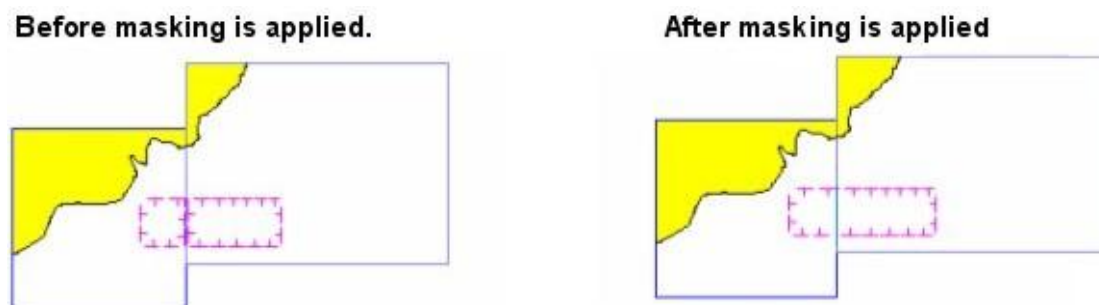

Surface feature crossing ENC cell boundaries

This allows the features to be displayed as a single feature of type surface rather than being divided at the cell boundary and having the representation of two separate features. Note that some ENC production software will automatically truncate (mask) features at the cell boundary.

NOTE: Occasionally an edge of the boundary of an area actually coincides with the ENC cell boundary. Where this occurs and the ENC production system applies automatic truncation (masking) of this edge, the compiler must “unmask” that edge so as to avoid the appearance of the area to be “open ended”.

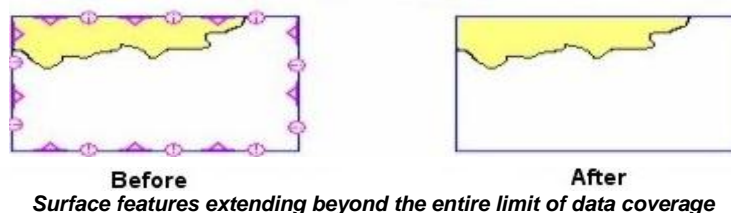

Surface features extending beyond the entire limit of data coverage

Where features of type surface extend beyond the entire limit of data coverage for the ENC cell (see clause X.X), all edges of these area features should be masked.

Where a cell contains an area of no data coverage and the ENC production software applies automatic truncation (masking) of features extending beyond the limit of data coverage of the ENC, edges of area features extending beyond the internal limit of the area of no data coverage may need to be masked manually.

The following table lists those features of type surface that should have edges masked where the boundary of the area crosses or extends beyond the ENC cell limit or the area of data coverage of the ENC cell.

Feature Type	Comment
Anchorage Area	
Cable Area	
Cargo Transhipment Area	
Caution Area	Also edges that are shared with Traffic Separation Scheme (TSS)
Dredged Area	
Dumping Ground	
Exclusive Economic Zone	
Fishery Zone	

Feature Type	Comment
Fishing Ground	
Harbour Area (Administrative)	
Ice Area	
Military Practice Area	
Offshore Production Area	
Pilotage District	When the whole cell falls within a pilotage area.
Pilot Boarding Place	
Precautionary Area	Not applied if it is within a TSS.
Quality of Bathymetric Data	
Quality of Survey	
Restricted Area Navigational	
Restricted Area Regulatory	
Sandwave	
Seaplane Landing Area	
Submarine Pipeline Area	
Submarine Transit Lane	
Territorial Sea Area	
Vegetation	
Vessel Traffic Service Area	
Water Turbulence	

2. Surface objects having ECDIS symbol pattern fill:

Surfaces symbolised in ECDIS with a patterned fill, and for which the outer edge of the surface has no significance (or is subject to change or intermittent), for example **Vegetation** (see Figure Surface feature with pattern fill below) or **Water Turbulence** features, may have the boundary of the surface masked to reduce screen clutter.

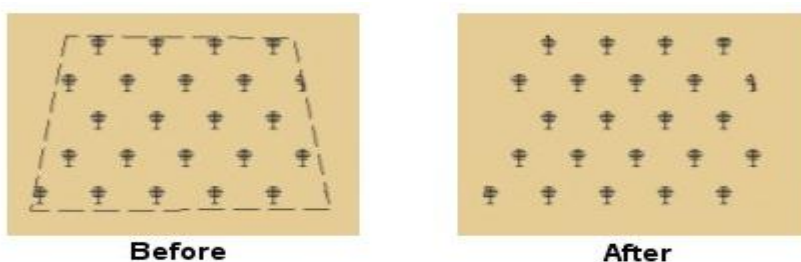

Surface feature with pattern fill

Compilers must take care that the surface is large enough at the maximum display scale of the ENC data (and at smaller maximum display scales at which it is intended that the feature should be displayed) so that at least one pattern symbol is displayed in the area. If this is not the case, the boundary of the surface should not be masked. Alternatively, a point feature may be encoded instead of the surface feature. It may be useful to load and display the ENC in an ECDIS in order to assist with making decisions as to the best encoding option to adopt in individual circumstances.

3. “Linear” surface features:

Where it is required to encode a linear feature when the only allowable primitive for the relevant feature type is surface (for example a “linear” maritime jurisdiction area (see clause X.X)), a “very narrow surface” should be encoded. An edge of this surface should correspond to the position of the line. All other edges should be masked.

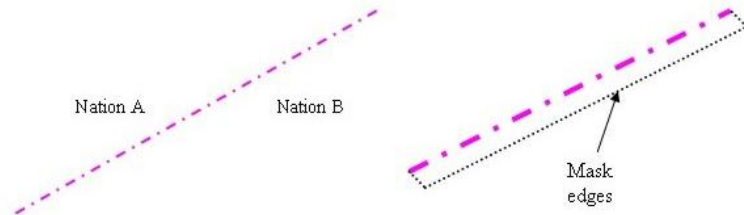

“Linear” maritime jurisdiction area

4. Routing measures – entrance and exit edges:

Routeing measures such as Traffic Separation Schemes (TSS), Two-Way Routes and Deep Water Routes have defined “ends” through which vessels enter and exit the route. Most routeing measures also consist of multiple components having different orientations. Where encoded, many of the features comprising the routeing measure symbolise along the edges of the area. Where the edges corresponding to the entry/exit points and between individual components of the route have not been masked, the impression of the route as a single routeing measure may not be apparent to the mariner, and cause confusion. Compilers should therefore mask the entry/exit edges, and all edges between components within the routeing measure.

The following table lists those area features that should have entry/exit edges, and all edges between components within the routeing measure masked.

Feature Type	Comment
Deep Water Route Part	
Fairway	
Inshore Traffic Zone	Only to be applied when the entrance and/or exit routes are known
Recommended Traffic Lane Part	
Traffic Separation Scheme lane Part	
Traffic Separation Scheme Roundabout	
Two-Way Route part	
Coverage	Coverage available, mask full coverage. (No Coverage available, don't mask)
Navigational System of Marks	Mask full coverage. If ORIENT is attributed don't mask.

The Figure below shows an example of a TSS with all appropriate edges of the components of the TSS masked.



Traffic Separation Scheme with appropriate masking

To give an indication of the effect of masking in a complex area such as a maritime area containing a TSS, the above Figure includes a **Caution Area** feature of type surface which has not had its edges masked. Due to the existence of the magenta “!” symbols within the **Caution Area**, and the fact that the edges of the **Caution Area** are coincident with the outer edge of the TSS, it is possible to further reduce ECDIS display clutter by masking the edges of the **Caution Area**. The resultant ECDIS display can be seen in the Figure below.

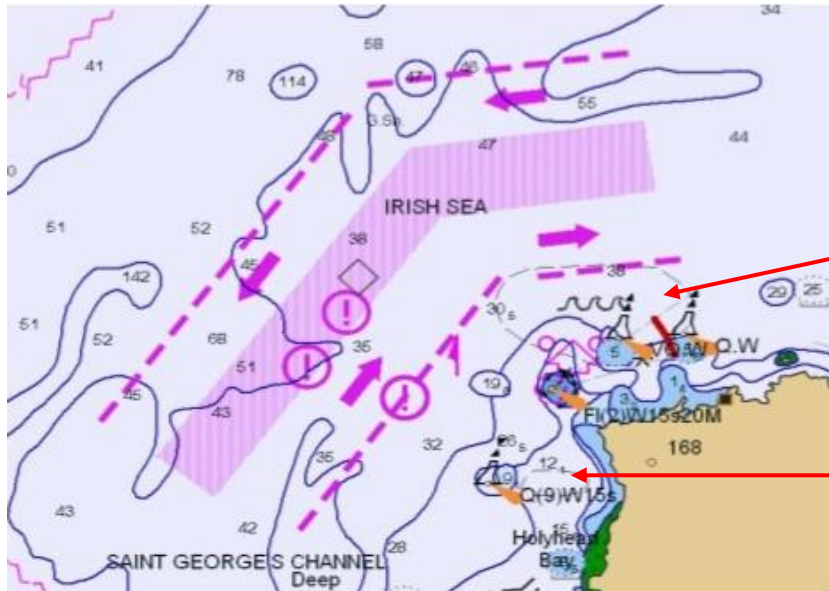

Traffic Separation Scheme with masked Caution Area

NOTE: In the example above it is also possible to mask the areas of water turbulence (indicated in the Figure above by red arrows – see scenario 2 above), however the small area to the east of the West cardinal buoy is too small to display the symbol at the maximum display scale of the ENC data. In cases such as this the compiler should consider capturing this as a **Water Turbulence** feature of type point.

2.6 Description of table format for S-101 meta and geo features

X.X Clause heading

<u>IHO Definition:</u> FEATURE: Definition. (Authority for definition).				
S-101 Geo Feature: Feature (S-57 Acronym) S-101 feature type, name and corresponding S-57 acronym				
Primitives: Point, Curve, Surface Allowable geometric primitive(s)				
<i>Real World</i> Example of real world instance(s) of the Feature.	<i>Paper Chart Symbol</i> Example(s) of paper chart equivalent symbology for the Feature.	<i>ECDIS Symbol</i> Example(s) of ECDIS symbology for the Feature.		
S-101 Attribute	S-57 Acronym	Allowable Encoding Value	Type	Multiplicity
Category of beer		1 : ale 2 : lager 3 : porter 4 : stout 5 : pilsener 6 : bock beer 7 : wheat beer 8 : pale ale 9 : indian pale ale	EN	1,1
This section lists the full list of allowable attributes for the S-101 feature. Attributes are listed in alphabetical order. Sub-attributes (Type prefix (S)) of complex (Type C) attributes are listed in alphabetical order and indented directly under the entry for the complex attribute (see below for example).	This section lists the corresponding S-57 attribute acronym. A blank cell indicates no corresponding S-57 acronym.	This section lists the allowable encoding values for S-101 (for enumerate (E) Type attributes only). Further information about the attribute is available in Section XX.	Attribute type (see clause X.X).	Multiplicity describes the "cardinality" of the attribute in regard to the feature. See clause X.X.
Fixed date range			C	0,1
Date end	(DATEND)		(S) TD	0,1
Date start	(DATSTA)		(S) TD	0,1
<u>INT 1 Reference:</u> The INT 1 location(s) of the Feature – by INT1 Section and Section Number.				
X.X.X Sub-clause heading(s) (see S-4 – B-YYY.Y)				
Introductory remarks. Includes information regarding the real world entity/situation requiring the encoding of the Feature in the ENC, and where required nautical cartographic principles relevant to the Feature to aid the compiler in determining encoding requirements.				
Specific instructions to encode the feature.				
<u>Remarks:</u>				
<ul style="list-style-type: none"> Additional encoding guidance relevant to the feature. 				
X.X.X.X Sub-sub-clause heading(s) (see S-4 – B-CCC.C)				
Clauses related to specific encoding scenarios for the Feature. (Not required for all Features).				
<u>Remarks:</u>				
<ul style="list-style-type: none"> Additional encoding guidance relevant to the scenario (only if required). 				
<u>Distinction:</u> List of features in the Product Specification distinct from the Feature.				

Feature/Information associations							
Type	Association Name	Association Ends					
		Class	Role	Mult	Class	Role	Mult
Aggr Asso Comp	Name of the association (see Section X.X)	Feature or Information Type at “this” end	At “this” end	At “this” end	Feature or Information Type(s) at “other” end	At “other” end	At “other” end
Remarks: Optional: Any constraints or remarks about the association.							

Remarks:

- S-101 Attribute: Indentation of attributes indicates sub-attributes of complex attributes. Complex attributes may also be sub-attributes of complex attributes, which is indicated by further indentation of the attribute name in the tables.
- S-101 Attribute: Attributes shown in grey text are ECDIS “system” attributes which are populated by the ENC production system in order to assist with portrayal of ENC data in ECDIS (see Section X.X). These attributes may be further edited by the compiler as required.
- S-57 Acronym: S-57 attribute acronyms shown in italic style text have been re-modelled in S-101 from S-57.
- Allowable Encoding Value: For (EN) type attributes, the enumerates listed are only those allowable for the particular occurrence of the attribute relevant to the feature. Allowable values may vary for the attribute depending on the feature to which the attribute is bound. Such bindings are defined in the S-101 Feature Catalogue. The full list of enumerates that may be assigned to an attribute in S-101 can be found in Section XX – Attribute and Enumerate Descriptions – of this document.
- Type: The prefix (C) indicates that the attribute is a complex attribute. Complex attributes are aggregates of other attributes that can be simple type or complex type (see clause X.X). The prefix (S) indicates that the attribute is a sub-attribute of a complex attribute. Complex attributes that are sub-attributes of a complex attribute, and their sub-attributes, are indicated by indentation of the attribute name in the S-101 Attribute column.
- Feature/Information associations/ Type: Is one of the role types association (Asso), aggregation (Aggr) or composition (Comp) (see clause X.X).
- Feature/Information associations/Association name: Is the name of the feature association (see Section X).
- Feature/Information associations/Role: Is the association role (see Section X) for both ends of the association, with the left role as it relates to the feature or information class table.
- Feature/Information associations/Mult: Lists the cardinality of the relationships for both ends of the association, with the left cardinality as it relates to the feature or information class table.
- Example of a feature association: The following extract from the S-101 Application Schema shows the **Island Aggregation** feature association:

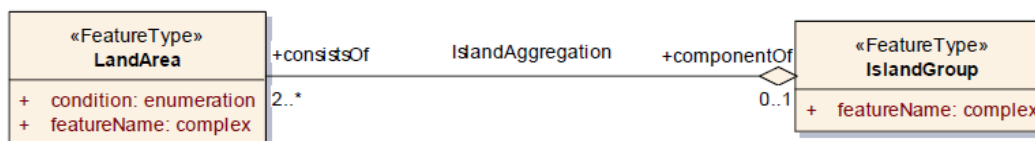

For the **Land Area** table entry (see clause X.X) the information association is shown as follows (see also table for **island Group** (see clause X.X) for the corresponding (or reverse) information association entry:

Feature/Information associations							
Type	Association Name	Association Ends					
		Class	Role	Mult	Class	Role	Mult
Aggr	Island Aggregation	Land Area	Consists of	2,*	Island Group	Component of	0,1

3 Metadata Features

The maximum use must be made of meta features to reduce the attribution on individual features. In a base dataset (EN Application profile, see S-101 ENC Product Specification main document clause X.X), some meta features are mandatory.

These mandatory meta features are in the following list:

Data Coverage: In order to assist in data discovery, the meta feature **Data Coverage** must be used to provide coverage of the part of the dataset covered by Skin of the Earth features. See clause X.X.

Navigational System of Marks: The meta feature **Navigational System of Marks** must provide an exhaustive non-overlapping coverage of the part of the dataset containing data. See clause X.X.

Quality of Bathymetric Data: The meta feature **Quality of Bathymetric Data** defines areas within which uniform assessment exists for the quality of bathymetric data, and is used to provide an assessment of the overall quality of bathymetric data to the mariner. Areas of a dataset at maximum display scale 1:700000 and larger containing depth data or bathymetry must be covered by one or more **Quality of Bathymetric Data** features, which may overlap vertically (see clause X.X). At maximum display scales smaller than 1:700000, **Quality of Bathymetric Data** features must be encoded where no larger maximum display scale ENC data is available.

3.1 Horizontal uncertainty

The attributes **quality of horizontal measurement** and **horizontal position uncertainty** may be applied to any spatial type, in order to qualify the location of a feature.

If it is required to encode the uncertainty of a horizontal clearance (complex attributes **horizontal clearance fixed** and **horizontal clearance open**), it must be done using the sub-attribute **horizontal distance uncertainty**.

horizontal distance uncertainty applies only to **horizontal clearance fixed** and **horizontal clearance open**. There is no attribute to express the accuracy of the attributes **horizontal length** and **horizontal width**.

Horizontal distance uncertainty, **horizontal position uncertainty** and **quality of horizontal measurement** must not be applied to the spatial type of any geo feature if they are identical to the **horizontal distance uncertainty**, **horizontal position uncertainty** and **quality of horizontal measurement** values of the underlying meta feature.

Quality of horizontal measurement gives qualitative information, whereas **horizontal position uncertainty** gives quantitative information.

Remarks:

No remarks.

3.2 Vertical uncertainty

If it is required to encode the uncertainty of a vertical clearance (complex attributes **vertical clearance fixed**, **vertical clearance open**, **vertical clearance closed** and **vertical clearance safe**), it must be done using the complex sub-attribute **vertical uncertainty**.

If several vertical clearances are given for one feature, the uncertainty given must be that of the least accurate.

Remarks:

No remarks.

3.3 Quality of non-bathymetric data

IHO Definition: **QUALITY OF NON-BATHYMETRIC DATA.** An area within which a uniform assessment of the quality of the non-bathymetric data exists. (Adapted from S-57 Edition 3.1, Appendix A – Chapter 1, Page 1.208, November 2000).

S-101 Metadata Feature: Quality of non-bathymetric data (M_ACCY)

Primitives: Surface

Real World

Paper Chart Symbol

ECDIS Symbol

S-101 Attribute	S-57 Acronym	Allowable Encoding Value	Type	Multiplicity
Category of temporal variation		1 : extreme event 2 : likely to change 3 : likely to change but significant shoaling not expected 4 : unlikely to change 5 : unassessed	EN	1,1
Horizontal distance uncertainty	(HORACC)		RE	0,1
Horizontal position uncertainty	(POSACC)		RE	1,1
Orientation uncertainty			RE	0,1
Survey date range			C	0,1
Date end	(SUREND)	ISO 8601:2004	(S) TD	1,1
Date start	(SURSTA)	ISO 8601:2004	(S) TD	0,1
Vertical uncertainty	(VERACC)		C	0,1
Uncertainty fixed			(S) RE	1,1
Uncertainty variable			(S) RE	0,1

INT 1 Reference:

3.3.1 Quality of non-bathymetric data

The meta feature **Quality of Non-bathymetric Data** may be used to provide an indication of the overall uncertainty of position for all non-bathymetric features. It must not be used to provide the uncertainty of bathymetric information.

Horizontal position uncertainty on the **Quality of Non-bathymetric Data** applies to non-bathymetric data situated within the area, while **quality of horizontal measurement** or **horizontal position uncertainty** on the associated spatial types qualifies the location of the **Quality of Non-bathymetric Data** feature itself.

Meta features **Quality of Non-bathymetric Data** and **Quality of Bathymetric Data** may overlap.

Remarks:

- No remarks.

Distinction: Quality of bathymetric data; quality of survey.

3.4 Data coverage

IHO Definition: COVERAGE. A geographical area that describes the coverage and extent of spatial types. (Adapted from S-57 Edition 3.1, Appendix A – Chapter 1, Page 1.210, November 2000).

S-101 Metadata Feature: Data Coverage (M_COVR)

Primitives: Surface

<i>Real World</i>	<i>Paper Chart Symbol</i>	<i>ECDIS Symbol</i>		
S-101 Attribute	S-57 Acronym	Allowable Encoding Value	Type	Multiplicity
Maximum display scale		maximum display scale < minimum display scale	IN	1,1
Minimum display scale		minimum display scale > maximum display scale	IN	1,1

INT 1 Reference:

3.4.1 Coverage

The meta feature **Data Coverage** encodes the area covered by data within the dataset. This feature is also used to provide the ECDIS with the scale information necessary for the determination of dataset loading and unloading in relation to the user selected viewing scale in the ECDIS. There must be a minimum of one **Data Coverage** feature in the dataset. **Data Coverage** features must cover the equivalent area to the extent of the spatial types in the dataset, and must not overlap (see clause **X.X**).

The mandatory attribute **maximum display scale** is used to indicate the largest intended viewing scale for the data. The value populated for **maximum display scale**, therefore, provides a reference for the user selected viewing scale in the ECDIS at which the overscale warning will be displayed if there is no larger maximum display scale ENC dataset available, as well as the ECDIS viewing scale when the cell is loaded. The value also determines the dataset loading strategy as the user defined viewing scale becomes smaller through a series of ENC cells covering a geographic area.

The mandatory attribute **minimum display scale** is used to indicate the smallest intended viewing scale for the data. Where an empty (null) value is populated for **minimum display scale**, the ECDIS will continue to display the data regardless of how small the user selected viewing scale becomes. The value populated for **minimum display scale**, therefore, is intended to be used in a series of ENC cells covering a geographic area to determine the dataset loading strategy as the user selected viewing scale becomes larger.

For ENC, in order to provide a consistent relationship between the encoded data and the way the data is displayed, the values for **maximum display scale** and **minimum display scale** must be taken from the following table:

Maximum display scale	Minimum display scale
10,000,000	empty (null)
3,500,000	10,000,000
1,500,000	3,500,000
700,000	1,500,000
350,000	700,000
180,000	350,000
90,000	180,000
45,000	90,000

22,000	45,000
12,000	22,000
8,000	12,000
4,000	8,000
3,000	4,000
2,000	3,000
1,000	2,000

Typically, only a single **Data Coverage** feature should be used in a dataset. However, if the maximum display scale is different for discrete areas within a single ENC dataset, this must be indicated by encoding separate, non-overlapping **Data Coverage** features, each having a different value populated for **maximum display scale**. Producing Authorities are to note, however, that excessive use of multiple **Data Coverage** features having different values of **maximum display scale** within a single dataset must be avoided, with a maximum number of 3 **Data Coverage** features being permitted. Where different values of **maximum display scale** are used, this should be restricted only to data compiled in order to achieve the intended navigational purpose of the entire dataset. If populated, datasets must have the same value for **minimum display scale** for all **Data Coverage** features in the dataset.

Normally, the nearest larger scale value from the table above, based on the intended optimum display scale for the ENC data as determined by the Producing Authority, must be used for **maximum display scale**, for example an ENC produced from a 1:25000 paper chart should have attribute **maximum display scale** = 22000.

Exceptionally, if source material permits, the next larger scale value from the table may be used.

Where a series of differing maximum display scale ENC datasets are compiled covering the same geographic area, the smallest scale value populated for **maximum display scale** for **Data Coverage** feature(s) in the dataset should correspond to the **minimum display scale**, where populated, for the next largest maximum display scale ENC dataset. The largest scale value populated for **maximum display scale** for **Data Coverage** feature(s) in the dataset must not be a larger scale value than the **maximum display scale** for the next largest maximum display scale ENC dataset, where such a dataset exists.

Remarks:

- This meta feature is intended to support an indication of coverage.
- Where more than one **Data Coverage** feature exists for a dataset, the dataset, when loaded, will be displayed in the ECDIS at a display scale corresponding to the largest scale value populated for **maximum display scale**.
- Where a dataset consists of only one **Data Coverage** feature, the value for the maximum display scale populated in the dataset discovery metadata must be the same as the value populated for **maximum display scale** on the **Data Coverage**.

Distinction:

3.5 Navigational system of marks

IHO Definition: **NAVIGATIONAL SYSTEM OF MARKS.** An area within which a specific system of navigational marks applies. (Adapted from S-57 Edition 3.1, Appendix A – Chapter 1, Page 1.214, November 2000).

S-101 Metadata Feature: Navigational system of marks (M_NSYS)

Primitives: Surface

Real World

Paper Chart Symbol

ECDIS Symbol

S-101 Attribute	S-57 Acronym	Allowable Encoding Value	Type	Multiplicity
Marks navigational – system of	(MARSYS)	1 : IALA A 2 : IALA B 9 : no system 11 : CEVNI	EN	1,1

INT 1 Reference:

3.5.1 Buoyage systems (see S-4 – B-461)

The buoyage system of the dataset must be encoded using the meta feature **Navigational System of Marks**:

All parts of the dataset containing data must be covered by **Navigational System of Marks** features, with the attribute **marks navigational – system of** indicating the buoyage system in operation. **Navigational System of Marks** must not overlap.

Individual buoys and beacons may not be part of the general buoyage system. This should be encoded using the attribute **marks navigational – system of** on these buoy and beacon features.

Remarks:

- For guidance regarding the encoding of aids to navigation in the IALA maritime buoyage system, see clause **X.X**.
- If it is required to encode an area within which the navigational system of marks has been established in relation to a specific direction, it must be done using the feature **Local Direction of Buoyage** (see clause **X.X**).

Distinction: Local direction of buoyage.

3.6 Local direction of buoyage

IHO Definition: **LOCAL DIRECTION OF BUOYAGE.** An area within which the navigational system of marks has been established in relation to a specific direction. (Adapted from S-57 Edition 3.1, Appendix A – Chapter 1, Page 1.214, November 2000).

S-101 Metadata Feature: Local direction of buoyage (*M_NSYS*)

Primitives: Surface

Real World

Paper Chart Symbol

ECDIS Symbol

S-101 Attribute	S-57 Acronym	Allowable Encoding Value	Type	Multiplicity
Orientation			C	1,1
Orientation uncertainty			(S) RE	0,1
Orientation value	(ORIENT)		(S) RE	1,1
Scale minimum	(SCAMIN)	See clause X.X	IN	0,1

INT 1 Reference:

3.6.1 Local direction of buoyage (see S-4 – B-461.5)

Within a dataset, there may be some areas where the direction of buoyage is defined by local rules and must, therefore, be specified. If required, these areas must be encoded as **Local Direction of Buoyage** features, with the mandatory complex attribute **orientation** indicating the direction of buoyage. **Local Direction of Buoyage** features must not overlap, but in areas where local buoyage directions apply, **Local Direction of Buoyage** features must overlap **Navigational System of Marks** features (see clause X.X) (see Figure below).

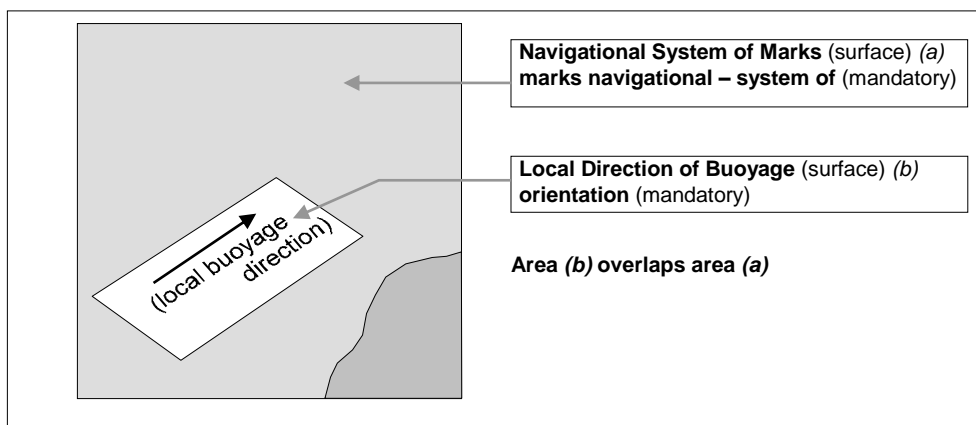

Buoyage system and direction

Remarks:

- No remarks.

Distinction: Navigational system of marks.

3.7 Quality of bathymetric data

IHO Definition: **QUALITY OF BATHYMETRIC DATA.** An area within which a uniform assessment of the quality of the bathymetric data exists. (S-57 Edition 3.1, Appendix A – Chapter 1, Page 1.216, November 2000).

S-101 Metadata Feature: Quality of Bathymetric Data (M_QUAL)

Primitives: Surface

Real World

Paper Chart Symbol

ECDIS Symbol

S-101 Attribute	S-57 Acronym	Allowable Encoding Value	Type	Multiplicity
Category of temporal variation		1 : extreme event 2 : likely to change 3 : likely to change but significant shoaling not expected 4 : unlikely to change 5 : unassessed	EN	1,1
Data assessment		1 : Assessed 2 : Oceanic 3 : Unassessed	EN	1,1
Depth range maximum value	(DRVAL2)		RE	0,1
Depth range minimum value	(DRVAL1)		RE	0,1
Features detected			C	1,1
Least depth of detected features measured			(S) BO	1,1
Significant features detected			(S) BO	1,1
Size of features detected			(S) RE	0,1
Full seafloor coverage achieved			BO	1,1
Horizontal position uncertainty	(POSACC)		RE	1,1
Survey date range			C	1,1
Date end	(SUREND)	ISO 8601:2004	(S) TD	1,1
Date start	(SURSTA)	ISO 8601:2004	(S) TD	0,1
Vertical uncertainty	(SOUACC)		C	1,1
Uncertainty fixed			(S) RE	1,1
Uncertainty variable			(S) RE	0,1

INT 1 Reference:

3.7.1 Quality, reliability and accuracy of bathymetric data (see S-4 – B-297)

Information about quality, reliability and uncertainty of bathymetric data is given using:

- the meta feature **Quality of Bathymetric Data** for an assessment of the quality of bathymetric data;
- the meta feature **Quality of Survey** for additional information about individual surveys (see clause X.X);
- the attributes **quality of vertical measurement**, **technique of vertical measurement** and complex attribute **vertical uncertainty** on groups of soundings or individual features;
- the attributes **horizontal position uncertainty**, **quality of horizontal measurement** and **category of temporal variation** on the spatial types (see clause X.X).

For the mariner, **Quality of Bathymetric Data** provides the most useful information. Therefore, the use of **Quality of Bathymetric Data** is mandatory for areas containing depth data or bathymetry on ENC datasets at maximum display scale 1:700000 and larger.

More detailed information about a survey may be given using **Quality of Survey** (see clause X.X). For example, in incompletely surveyed areas, lines of passage soundings may be indicated as such using a curve **Quality of Survey** feature. This information is more difficult for the mariner to interpret. Therefore, the use of **Quality of Survey** is optional.

For individual features (wrecks, obstructions etc), or small groups of soundings, **quality of vertical measurement**, **technique of vertical measurement** and **vertical uncertainty** may be used to provide additional information about quality and uncertainty.

The meta feature **Quality of Bathymetric Data** defines areas within which uniform assessment exists for the quality of bathymetric data, and must be used to provide an assessment of the overall quality of bathymetric data to the mariner. Areas of a dataset containing depth data or bathymetry must be covered by one or more **Quality of Bathymetric Data**, which may overlap vertically in order to define the quality of bathymetric data at varying depths in the water column.

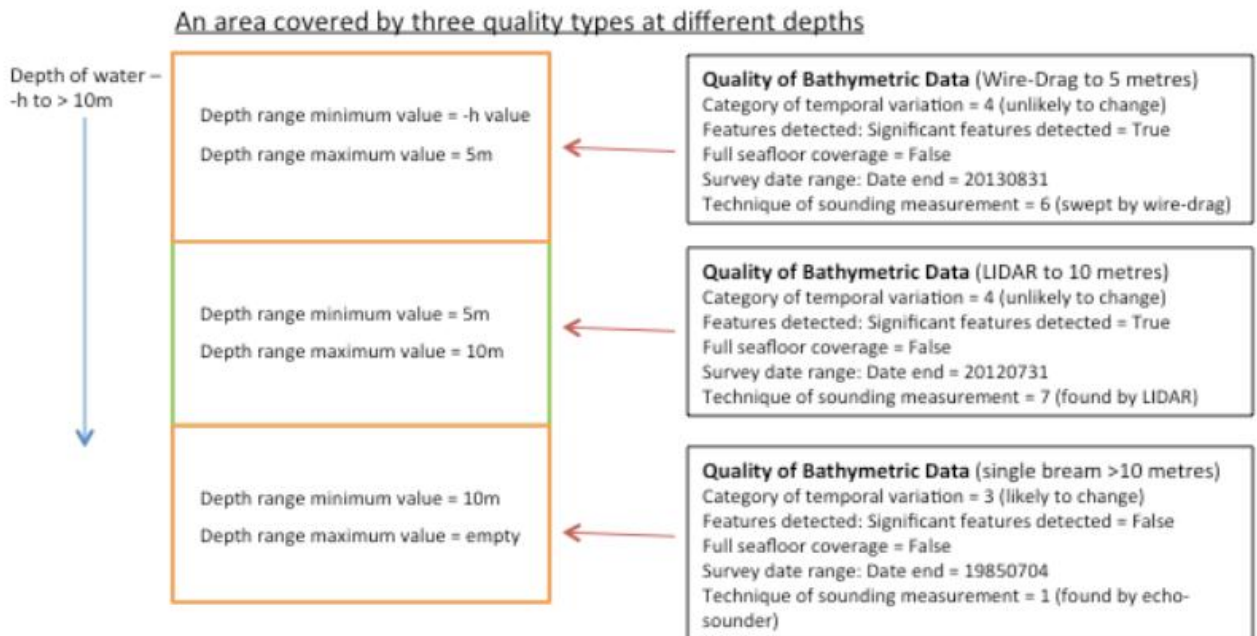

Remarks:

- The mandatory attribute **data assessment** provides an overall indicative level of assessment of bathymetric data from which further attribution is derived, and assists with portrayal of bathymetric data quality information in ECDIS:
 - Where the value for **data assessment** is set to 1 (assessed), all additional attribution for the **Quality of Bathymetric Data** feature must be indicative of the quality of bathymetric data for the area.
 - Where the value for **data assessment** is set to 2 (oceanic), all additional attribution for the **Quality of Bathymetric Data** feature should be indicative of the quality of bathymetric data for the area for a mariner's ECDIS pick report, however no portrayal of the quality information will display on the ECDIS.
 - Where the value for **data assessment** is set to 3 (unassessed), the mandatory attributes **category of temporal variation** = 5 (unassessed); **features detected** (least depth of detected features measured and significant features detected) = *False*; **full seafloor coverage achieved** = *False*; and **horizontal position uncertainty** and **vertical uncertainty (uncertainty fixed)** = [empty (null)] must be populated.
- To express completeness of bathymetric data, the complex attribute **features detected** must be encoded. **Features detected** indicates that a systematic method of exploring the sea floor, or the water column to the

depth indicated by population of the attribute **depth range maximum value**, was undertaken to detect significant features. The sub-attributes **size of features detected** and **least depth of detected features measured** must not be encoded unless the sub-attribute **significant features detected** is set to *True*.

- Wherever possible, meaningful and useful values for the attributes **category of temporal variation**, **full seafloor coverage achieved**, and the complex attribute **features detected** must be used for areas of bathymetry. For areas of unstable seafloors, the complex attribute **survey date range (date end)** must be used to indicate the date of the survey of the underlying bathymetric data.
- **Depth range minimum value** must only be used on a **Quality of Bathymetric Data** feature where a swept area occupies the entire **Quality of Bathymetric Data** surface, or **Quality of Bathymetric Data** features overlap. Where these features overlap such that varying bathymetric data qualities exist at different depths in the water column, the **depth range minimum value** for a **Quality of Bathymetric Data** must be equal to the **depth range maximum value** for the **Quality of Bathymetric Data** feature defining the quality for the level above (see diagram above).
- **Depth range maximum value** must only be used on a **Quality of Bathymetric Data** feature to specify the maximum depth to which all other attributes for the **Quality of Bathymetric Data** feature applies. When **depth range maximum value** is specified, values populated for all other attributes apply only to depths equal to or shallower than **depth range maximum value**. No quality information is provided for depths deeper than **depth range maximum value**. Where **Quality of Bathymetric Data** features overlap such that varying bathymetric data qualities exist at different depths in the water column, the **depth range maximum value** for a **Quality of Bathymetric Data** must be equal to the **depth range minimum value** for the **Quality of Bathymetric Data** feature defining the quality for the level below (see diagram above).
- **Quality of Bathymetric Data** encoded over **Unsurveyed Area** must have mandatory attributes **data assessment** = 3 (unassessed) **category of temporal variation** = 5 (unassessed); **features detected (least depth of detected features measured and significant features detected)** = *False*; **full seafloor coverage achieved** = *False*; and **horizontal position uncertainty** and **vertical uncertainty (uncertainty fixed)** = [empty (null)].
- **Horizontal position uncertainty** is used on a **Quality of Bathymetric Data** feature to specify the positional uncertainty of the depths covered by the surface.
- **Vertical uncertainty** is used on a **Quality of Bathymetric Data** feature to specify the vertical uncertainty of the depths covered by the surface. When **depth range minimum value** is specified, **vertical uncertainty** refers only to the uncertainty of the swept depth defined by **depth range minimum value**.
- If the attribute **technique of vertical measurement** is required, it must be encoded on either the meta feature **Quality of Survey** (see clause X.X) or on individual geo features (for example **Sounding**).
- When the **Quality of Bathymetric Data** surface contains data from only one survey, the date of survey must be specified using the complex attribute **survey date range**, sub-attribute **date end**. When the **Quality of Bathymetric Data** surface contains data from two or more surveys, the date of the most recent and the oldest survey must be specified using the complex attribute **survey date range**.
- Additional quality information may be given using the meta feature **Quality of Survey**.
- **Quality of Bathymetric Data** areas must not be encoded over land.
- **Horizontal position uncertainty** on the **Quality of Bathymetric Data** applies to bathymetric data situated within the surface, while **quality of horizontal measurement** or **horizontal position uncertainty** on the associated spatial types qualifies the location of the **Quality of Bathymetric Data** feature itself.
- As a result of some disasters, for example earthquakes, tsunamis, hurricanes, it is possible that large areas of seafloor have moved and/or become cluttered with dangerous obstructions. Emergency surveys may subsequently be conducted over essential shipping routes and inside harbours. Outside these surveys, all existing detail is now suspect, whatever the quality of the previous surveys. In such cases, the attribute **category of temporal variation** should be reclassified to value 1 (event), the Boolean attribute **full seafloor coverage achieved** set to *False*, and complex attribute **features detected**, Boolean sub-attributes **least depth of detected features measured** and **significant features detected** set to *False* in the affected areas outside the area covered by emergency surveys.
- Meta features **Quality of Bathymetric Data** and **Quality of Non-bathymetric Data** may overlap.

3.7.1.1 Feature detection

In the context of bathymetry, a feature is any object, whether manmade or not, projecting above the sea floor, which may be considered to be a danger to surface navigation. Refer to S-44.

The ability to detect bathymetric features must be encoded using the complex attribute **features detected**. The sub-attribute **significant features detected** indicates whether the survey was capable of detecting features of a size indicated by the sub-attribute **size of features detected**. The sub-attribute **least depth of detected features measured** indicates whether the least depth of detected features was found. For instance,

if a wreck was found, but it is not certain that the least depth of that wreck was measured, **least depth of detected features measured** must be set to *False*.

3.7.1.2 Temporal variation

The changeability of the bathymetry must be encoded using **category of temporal variation**. In order for a time reference to be given for the expression of temporal variation, the relevant dates of the bathymetric data must be encoded using the complex attribute **survey date range** if **category of temporal variation** is set to *1* (event) or *2* (likely to change).

3.7.1.3 Sounding uncertainty

Sounding uncertainty is encoded using the complex attribute **vertical uncertainty** on **Quality of Bathymetric Data**. If it is required to encode additional sounding uncertainty information, it must be done using the complex attribute **vertical uncertainty** on individual geo features (for example **Sounding**).

The uncertainty of sounding must not be encoded using **sounding uncertainty** on the depth geo feature, unless it is different from the value of **vertical uncertainty** encoded on **Quality of Bathymetric Data**.

Distinction: Quality of non-bathymetric data; quality of survey.

3.8 Sounding datum

IHO Definition: **SOUNDING DATUM.** The horizontal plane or tidal datum to which soundings have been reduced. Also called datum for sounding reduction. (Adapted from IHO Dictionary – S-32).

S-101 Metadata Feature: Sounding datum (M_SDAT)

Primitives: Surface

Real World

Paper Chart Symbol

ECDIS Symbol

S-101 Attribute	S-57 Acronym	Allowable Encoding Value	Type	Multiplicity
Vertical datum	(VERDAT)	1 : Mean low water spring 2 : Mean lower low water springs 3 : Mean sea level 4 : Lowest low water 5 : Mean low water 6 : Lowest low water springs 7 : Approximate mean low water springs 8 : Indian spring low water 9 : Low water springs 10 : Approximate lowest astronomical tide 11 : Nearly lowest low water 12 : Mean lower low water 13 : Low water 14 : Approximate mean low water 15 : Approximate mean lower low water 16 : Mean high water 17 : Mean high water springs 18 : High water 19 : Approximate mean sea level 20 : High water springs 21 : Mean higher high water 22 : Equinoctial spring low water 23 : Lowest astronomical tide 24 : Local datum 25 : International great lakes datum 1985 26 : Mean water level 27 : Lower low water large tide 28 : Higher high water large tide 29 : Nearly highest high water 30 : Highest astronomical tide (HAT)	EN	1,1

INT 1 Reference:

3.8.1 Sounding datum

Sounding datum information is encoded in the dataset metadata or by the meta feature **Sounding Datum**, and must be constant over large areas. The values encoded in the attributes **value of sounding**, **depth range minimum value**, **depth range maximum value** and **value of depth contour**, and the sounding values encoded in **Sounding** features (positive values down), are referenced to this datum.

The default value for the entire dataset must be given in the “Vertical Datum” [VDAT] subfield of the “Coordinate Reference System Header” [CRSH] field.

If the sounding datum for an area is different from the value given in the [VDAT] subfield for the dataset, it must be encoded using **Sounding Datum**. The areas covered by these meta features must not overlap. If it is required to encode a sounding datum for individual features that is different from the dataset header, or a **Sounding Datum** feature covering the features, it must be encoded using the attribute **vertical datum** on the individual features.

Depth contours, grouped soundings and depth areas going across areas having different values of sounding datum must be split at the border of those areas. Other features that should be split include **Marine Farm/Culture**, **Obstruction** and **Wreck**, but only where the value of **value of sounding** is known; and **Berth**, **Cable Submarine**, **Deep Water Route Centreline**, **Deep Water Route Part**, **Dredged Area**, **Dry Dock**, **Fairway**, **Floating Dock**, **Gate**, **Pipeline Submarine/On Land**, **Recommended Route Centreline**, **Recommended Track**, **Swept Area**, **Two-Way Route Part** and **Quality of Bathymetric Data**, but only if the value of **depth range minimum value** and/or **depth range maximum value** is known.

Remarks:

- No remarks.

Distinction: Vertical datum.

3.9 Vertical datum

IHO Definition: VERTICAL DATUM. Any level surface from which to reference elevations. Also called datum level, reference level, reference plane, levelling datum, datum for heights. (Adapted from IHO Dictionary – S-32).

S-101 Metadata Feature: Vertical datum of data (M_VDAT)

Primitives: Surface

Real World

Paper Chart Symbol

ECDIS Symbol

S-101 Attribute	S-57 Acronym	Allowable Encoding Value	Type	Multiplicity
Vertical datum	(VERDAT)	3 : Mean sea level 16 : Mean high water 17 : Mean high water springs 18 : High water 19 : Approximate mean sea level 20 : High water springs 21 : Mean higher high water 24 : Local datum 25 : International great lakes datum 1985 26 : Mean water level 28 : Higher high water large tide 29 : Nearly highest high water 30 : Highest astronomical tide (HAT)	EN	1,1

INT 1 Reference:

3.9.1 Vertical datum

Vertical datum information is encoded in the dataset metadata, using the meta feature **Vertical Datum of Data**, or by populating the attribute **vertical datum** on individual geo features. The values encoded in the attributes **elevation**, **height** and **clearance vertical** (positive values up) are referenced to the specified datum(s). **vertical datum** must not be encoded on any feature unless at least one of the above attributes is also encoded on that feature.

The default value for the entire dataset must be given in the “Vertical Datum” [VDAT] subfield of the “Coordinate Reference System Header field” [CRSH] field.

If the vertical datum for an area is different from the value given in the VDAT subfield for the dataset, it must be encoded using **Vertical Datum of Data**. The areas covered by these meta features must not overlap.

Height contours, going across areas having different values of vertical datum, must be split at the border of these areas.

Various height datums may be used within an ENC. For example, different datums may be used for the following:

- altitude of spot heights, height contours, landmarks,
- elevation of lights,
- vertical clearance.

Where different vertical datums are used for the various vertical measurements, the default value given in the metadata for the dataset or **Vertical Datum of Data** applies to the first group of the above list. The attribute **vertical datum** on an individual feature applies to the elevation of lights and vertical clearances and must only

be populated if different from the value given by the dataset metadata or **Vertical Datum of Data**.

Remarks:

- No remarks.

Distinction: Sounding datum.

3.10 Quality of survey

IHO Definition: QUALITY OF SURVEY. An area within which a uniform assessment of the reliability of source survey information exists. (S-57 Edition 3.1, Appendix A – Chapter 1, Page 1.218, November 2000).

S-101 Metadata Feature: Quality of survey (M_SREL)

Primitives: Curve, Surface

Real World

Paper Chart Symbol

ECDIS Symbol

S-101 Attribute	S-57 Acronym	Allowable Encoding Value	Type	Multiplicity
Depth range maximum value	(DRVAL2)		RE	0,1
Depth range minimum value	(DRVAL1)		RE	0,1
Features detected			C	0,1
Least depth of detected features measured			(S) BO	1,1
Significant features detected			(S) BO	1,1
Size of features detected			(S) RE	0,1
Full seafloor coverage achieved			BO	0,1
Line spacing maximum	(SDISMX)		IN	0,1
Line spacing minimum	(SDISMN)		IN	0,1
Measurement distance maximum			RE	0,1
Measurement distance minimum			RE	0,1
Quality of horizontal measurement	(QUAPOS)	3 : inadequately surveyed 4 : approximate 6 : unreliable	EN	0,1
Quality of vertical measurement	(QUASOU)	1 : depth known 2 : depth or least depth unknown 3 : doubtful sounding 4 : unreliable sounding 6 : least depth known 7 : least depth unknown, safe clearance at value shown 8 : value reported (not surveyed) 9 : value reported (not confirmed) 10 : maintained depth 11 : not regularly maintained	EN	0,*
Scale value maximum	(SCVAL1)	scale value maximum < scale value minimum	IN	0,1
Scale value minimum	(SCVAL2)	scale value minimum > scale value maximum	IN	0,1
Survey authority	(SURATH)		TE	1,1
Survey date range			C	1,1

Date end	(SUREND)	ISO 8601:2004	(S) TD	1,1
Date start	(SURSTA)	ISO 8601:2004	(S) TD	0,1
Survey type	(SURTYP)	1 : reconnaissance / sketch survey 2 : controlled survey 4 : examination survey 5 : passage survey 6 : remotely sensed 7 : full coverage 8 : systematic survey 9 : non-systematic survey 10 : inadequately surveyed 11 : spot-sounding survey 12 : acoustically swept survey 13 : mechanically swept survey	EN	1,*
Technique of vertical measurement	(TECSOU)	1 : found by echo-sounder 2 : found by side scan sonar 3 : found by multi-beam 4 : found by diver 5 : found by lead-line 6 : swept by wire-drag 8 : swept by vertical acoustic system 9 : found by electromagnetic sensor 10 : photogrammetry 11 : satellite imagery 12 : found by levelling 13 : swept by side-scan sonar 15 : found by LIDAR	EN	0,*

INT 1 Reference:

3.10.1 Survey reliability and source of bathymetric data

The survey reliability and/or details of the source surveys used in compilation may be encoded using the meta feature **Quality of Survey**.

Remarks:

- To express completeness of bathymetric data, the complex attribute **features detected** should be encoded. **features detected** indicates that a systematic method of exploring the sea floor was undertaken to detect significant features. The sub-attributes **size of features detected** and **least depth of detected features measured** must not be encoded unless the sub-attribute **significant features detected** is set to *True*.
- If the complex attribute **vertical uncertainty** is required, it must be encoded on either the meta feature **Quality of Bathymetric Data** (see clause X.X) or on individual geo features (for example **Sounding**).
- If the attribute **measurement distance maximum** is set to 0 (zero) for the full area of the survey, the attribute **full seafloor coverage achieved** should be set to yes.
- Where populated, the value for the attribute **measurement distance minimum** must not be larger than the value populated for **measurement distance maximum**.
- Quality of horizontal measurement** on the **Quality of Survey** applies to bathymetric data situated within the area, while **quality of horizontal measurement** or **horizontal position uncertainty** on the associated spatial types qualifies the location of the **Quality of Survey** feature itself.
- The attributes **depth range maximum value** and **depth range minimum value** may be used to define the quality of individual surveys at varying depths in the water column, similar to the method used for indicating the overall quality of bathymetry using **Quality of Bathymetric Data** (see clause X.X).

3.10.2 Quality of sounding

If it is required to encode the quality of sounding, it must be done using the attribute **quality of vertical measurement** on either the **Quality of Survey** or on individual geo features (for example **Sounding**).

The quality of sounding must not be encoded using **quality of vertical measurement** on the depth geo feature, unless it is different from the value of **quality of vertical measurement** encoded on **Quality of Survey** (see tables at clauses X.X and X.X).

3.10.3 Technique of vertical measurement

If it is required to encode the technique of sounding measurement, it must be done using the attribute **technique of vertical measurement** on either **Quality of Survey** or on individual geo features (for example **Sounding**).

Technique of vertical measurement must not be populated with multiple values to indicate the technique of sounding measurement for multiple surveys. **Technique of vertical measurement** may be populated with multiple values only where the area is covered by a survey that has used multiple techniques, for example an area covered by a survey using a modern echosounder combined with a sonar or mechanical sweep system.

The technique of sounding measurement must not be encoded using **technique of vertical measurement** on the depth geo feature, unless it is different from the value of **technique of vertical measurement** encoded on an overlapping **Quality of Survey**; and the information is considered to be important to navigation.

Remarks:

- No remarks.

Distinction: Accuracy of data; quality of bathymetric data

3.11 Update information

IHO Definition: **UPDATE INFORMATION.** The Update Information metadata feature is used to represent a change to the information shown.

S-101 Metadata Feature: Update information

Primitives: Point, Curve, Surface

Real World

Paper Chart Symbol

ECDIS Symbol

S-101 Attribute	S-57 Acronym	Allowable Encoding Value	Type	Multiplicity
Update description			C	1,*
Language		ISO 639-3	(S) TE	0,1
Text			(S) TE	1,1
Scale minimum	(SCAMIN)	See clause X.X	IN	0,1
Source			TE	0,1

INT 1 Reference:

3.11.1 Update information

If it is required to encode information about changes made to ENC data it must be done using **Update Information**. This feature must be encoded to cover the extent of changed data incorporated in the SENC via ENC Updates (ER Application Profile), and may also be used to indicate changes introduced in ENC New Editions. It carries information about the changes. **Update Information** may be associated with features which have changed using the association **Updated Information** (see clause X.X).

Remarks:

- The mandatory attribute **update description** must be used to provide a brief textual description of the changes to the dataset included in the Update. If a more detailed description of the Update is required, this should be encoded using an associated instance of the information class **Nautical Information** (see clause X.X), complex attribute **information**.
- The attribute **source** may be used to indicate the related paper chart notice to mariner's number.
- At each new edition of an ENC cell **Update Information** features which are no longer relevant must be deleted.
- Where information has been deleted from an ENC the **Update Information** feature should cover the extent of the deleted information.

Distinction: Information area; caution area.

Feature/Information associations

Type	Association Name	Association Ends					
		Class	Role	Mult	Class	Role	Mult
Asso	Updated Information	Update Information	Updates	0,1	All Geo features	Identifies	1,*

4 Geo Features – Magnetic Data

4.1 Magnetic Variation

IHO Definition: **MAGNETIC VARIATION.** The angle between the magnetic and geographic meridians at any place, expressed in degrees east or west to indicate the direction of magnetic north from true north. Also called magnetic declination. (IHO Dictionary – S-32).

S-101 Geo Feature: Magnetic variation (MAGVAR)

Primitives: Point, Curve, Surface

Real World

Paper Chart Symbol

ECDIS Symbol

S-101 Attribute	S-57 Acronym	Allowable Encoding Value	Type	Multiplicity
Reference year for magnetic variation	(RYRMGV)	ISO 8601:2004 (YYYY----)	TD	1,1
Value of annual change in magnetic variation	(VALACM)	+/- minutes. Positive (unsigned) value indicates easterly. Negative value indicates westerly	RE	1,1
Value of magnetic variation	(VALMAG)	+/- degrees. Positive (unsigned) value indicates easterly. Negative value indicates westerly	RE	1,1
Scale minimum	(SCAMIN)	See clause X.X	IN	0,1

INT 1 Reference: B 68, 70-71

4.1.1 Magnetic variation (see S-4 – B-261; B-270 to B-273)

Of the various magnetic data, magnetic variation is the most important element for the mariner. Until a world magnetic model is universally available for inclusion in ECDIS, if it is required to encode magnetic variation, it must be done using the feature **Magnetic Variation**. As a minimum, updates to the magnetic variation should be supplied to coincide with changes of epoch (that is, every five years).

Remarks:

- There remains a requirement to include magnetic variation information in ENC's whilst SOLAS regulations include the requirement for a magnetic compass and deviation card. User feedback indicates that it can be difficult to access magnetic variation information in ECDIS where it has been encoded using the point or curve primitive. In order to make magnetic variation information easily accessible to ECDIS users, it is recommended to encode this information as **Magnetic Variation** features of type surface. Encoding this information using the surface primitive ensures that the user can interrogate the ENC data using the ECDIS Pick Report function at any chart location to identify the value of magnetic variation at that location.
- The mandatory attribute **reference year for magnetic variation** must be used to populate the year value only (see clause X.X for format of date type attributes).
- Magnetic models are typically updated every five years (for example 2005, 2010... termed epochs). Magnetic variation can be calculated from computer models, or derived from charts produced by certain Hydrographic Offices or mapping authorities, which show the spatial distribution of magnetic variation values worldwide for the current epoch, by means of lines of equal magnetic variation (termed isogonals). The rate-of-change curves, which are over-printed on such charts, enable values for any point to be extrapolated for any time within the current epoch.

Distinction: Local magnetic anomaly.

4.2 Local Magnetic Anomaly

IHO Definition: **LOCAL MAGNETIC ANOMALY.** An anomaly of the magnetic field of the Earth, extending over a relatively small area, due to local magnetic influences. Also called local attraction or magnetic anomaly. (IHO Dictionary – S-32).

S-101 Geo Feature: Local magnetic anomaly (LOCMAG)

Primitives: Point, Curve, Surface

Real World

Paper Chart Symbol

ECDIS Symbol

S-101 Attribute	S-57 Acronym	Allowable Encoding Value	Type	Multiplicity
Feature name			C	0,*
Display name			(S) BO	0,1
Language		ISO 639-3	(S) TE	0,1
Name	(OBJNAM) (NOBJNM)		(S) TE	1,1
Reported date	(SORDAT)	ISO 8601:2004	TD	0,1
Value of local magnetic anomaly			C	1,1
Magnetic anomaly value maximum	(VALLMA)	anomaly value maximum < anomaly value minimum (+/- minutes)	(S) RE	1,1
Magnetic anomaly value minimum		anomaly value minimum > anomaly value maximum (+/- minutes)	(S) RE	0,1
Scale minimum	(SCAMIN)	See clause X.X	IN	0,1

INT 1 Reference: B 82.1-2

4.2.1 Local magnetic anomaly (see S-4 – B-274)

If it is required to encode an abnormality in magnetic variation for a localised area, it must be done using the feature **Local Magnetic Anomaly**.

If the area cannot be defined, the feature should be represented as a point.

Remarks:

- Where the mandatory complex attribute **value of local magnetic anomaly** contains a value in the sub-attribute **magnetic anomaly value maximum** only, the deviation is assumed to be positive and negative by that amount. Where the positive and negative values for the local magnetic anomaly differ, the positive value must be populated in **anomaly value maximum**, and the negative value in the sub-attribute **magnetic anomaly value minimum**. The plus/minus character must not be encoded.
- Abnormal magnetic variation should not be encoded unless it varies by more than about 3° from the normal magnetic variation (see clause X.X) for the area.

Distinction: Magnetic variation.

5 Geo Features – Natural Features

The use of Global Navigation Satellite Systems (GNSS) as an integral component of ECDIS has raised questions as to the level of topographic detail that is required in ENC's to enable safe navigation using ECDIS. When determining the topographic information necessary for inclusion in ENC, all operational conditions of vessels must be taken into consideration, including the potential for corruption or failure of a vessel's GNSS reception. Such a failure would require the mariner to navigate by fixing their position using traditional methods, necessitating a sufficient level of depiction of topographic detail in the ENC to facilitate navigation using these methods, appropriate to the Navigational Purpose of the ENC.

In addition, mariners will continue to use visual or radar fixing as an independent method of confirming the position of their vessel as shown on the ECDIS, in order to gain a greater level of confidence in terms of their navigation.

Encoders are advised, therefore, that when determining the level of depiction of topographic detail required for ENC, this should be done in accordance with the following principles:

The types of features charted and the distance inland to which they are shown will vary with the maximum display scale of the ENC data, type of terrain, availability of source data and, possibly, adequacy of regular navigational aids. The significance to the mariner must be judged by the requirements of both visual and radar navigation.

The navigator sees the coast in profile; the cartographer compiles it in plan and must always be aware that the navigator's interest in land detail is at its greatest at the coastline and falls off rapidly inland. On a low-lying coast, even minor clues to position near the coast, for example sand dunes, hillocks, low bluffs, may be very useful on most detailed ENC datasets. On steep coasts with deep water close inshore, sea traffic is likely to be concentrated off projecting points of land, and the nature of each headland must be made clear, whether it has vertical cliffs, or a sloping or low profile, for example.

Off coasts inadequately marked by navigational aids, detailed topography in the coastal belt will allow the mariner to clear dangers with the aid of improvised visual transits of charted topographical features.

No definite standards can be stated but the following principles should be observed:

- The density of topographic detail shown should be kept to a minimum consistent with providing navigators with all identifiable features and with a general picture of the relief as far as the probable skyline. This practice should enable landmarks to stand out from less important detail.
- Treatment of detail should vary with distance inland, for example inconspicuous features such as marshes and minor lakes and streams should be shown only when within about a mile of the coast.

Additional guidance regarding the level of depiction of topographic detail in regard to specific features is included in the following clauses.

5.1 Cliffs (see S-4 – B-312.3)

A coast backed by rock or earth cliffs gives a good radar return and is useful for visual identification from a considerable distance off, where cliffs alternate with low lying coast along the shoreline. Where cliffs are prominent features they should be encoded on the larger maximum display scale for the ENC data; as an exception, where cliffs predominate over extensive stretches of coastline, it may be neither feasible nor particularly useful to insert a cliff throughout. Cliff top heights are useful for calculating or estimating distance off, (for clearing inshore dangers) and should be encoded where possible.

If it is required to encode a non-coastal cliff, it must be done using the feature **Sloping Ground** (see clause X.X) and/or using the feature **Slope Topline** (see clause X.X), with attribute **category of slope** = 6 (cliff). For example:

Sloping Ground may be used at large scale to indicate the horizontal extent of the cliff.

Slope Topline should be used on its own to encode cliffs at small scale, or in conjunction with **Sloping Ground** to indicate the crest of the cliff when it is considered useful to know its elevation, and/or to encode a cliff on land distant from the coastline.

Remarks:

- When the cliff is coincident with the coastline, a **Coastline** feature, with attribute **category of coastline** = 1 (steep coast) should be encoded, and there should be no **Sloping Ground** or **Slope Topline** encoded.

5.2 Cuttings and embankments (see S-4 – B-363.2 and B-364.1)

If it is required to encode cuttings and embankments, this must be done in the same way as cliffs; using **Sloping Ground** and/or **Slope Topline** features (see clauses X.X and X.X), with attribute **category of slope** = 1 (cutting) or 2 (embankment).

Remarks:

- Cuttings and embankments should be encoded only when likely to be visible from seaward.

5.3 Coastline

IHO Definition: **COASTLINE.** A line where shore and water meet. Although the terminology of coasts and shores is rather confused, shoreline and coastline are generally used as synonyms. (IHO Dictionary – S-32).

S-101 Geo Feature: Coastline (COALNE)

Primitives: Curve

Real World

Paper Chart Symbol

ECDIS Symbol

S-101 Attribute	S-57 Acronym	Allowable Encoding Value	Type	Multiplicity
Category of coastline	(CATCOA)	1 : steep coast 2 : flat coast 6 : glacier (seaward end) 7 : mangrove 8 : marshy shore 10 : ice coast	EN	0,1
Colour	(COLOUR)	1 : white 2 : black 3 : red 4 : green 6 : yellow 7 : grey 8 : brown 11 : orange 13 : pink	EN	0,*
Elevation	(ELEVAT)		RE	0,1
Feature name			C	0,*
Display name			(S) BO	0,1
Language		ISO 639-3	(S) TE	0,1
Name	(OBJNAM) (NOBJNM)		(S) TE	1,1
Nature of surface	(NATSUR)	1 : mud 2 : clay 3 : silt 4 : sand 5 : stone 6 : gravel 8 : cobbles 9 : rock 11 : lava 14 : coral 17 : shells	EN	0,*
Radar conspicuous	(CONRAD)		BO	0,1
Visually conspicuous	(CONVIS)	1 : visually conspicuous 2 : not visually conspicuous 3 : prominent	EN	0,1

INT 1 Reference: C 1-8, 25, 32-33

5.3.1 Coastline (see S-4 – B-310 and B-311)

Natural sections of coastlines, lakeshores and riverbanks should be encoded as **Coastline**, whereas artificial sections of coastlines, lakeshores, riverbanks, canal banks and basin borders should be encoded as

Shoreline Construction (see clause X.X). The exception to this general rule is when a lake, river, canal, or basin is not navigable at the maximum display scale for the ENC data, in which case the boundary of the lake, river, canal, or basin must not be encoded as **Coastline** or **Shoreline Construction** as the boundary of these specific areas (**Lake, River, Canal, Dock Area, Lock Basin**) create the portrayal of the bank or shoreline.

Coastline and **Shoreline Construction** features form the border of the **Land Area** feature (see clause X.X).

5.3.2 Natural coastline (see S-4 – B-312 and B-353.8)

Spatial types associated with coastlines considered to be inadequately surveyed at the maximum display scale for the ENC data (see S-4 – B-311) should be encoded using spatial attribute **quality of horizontal measurement** = 3 (inadequately surveyed).

If it is required to encode a description of the nature of the coastline, it must be done using the attributes **category of coastline** and **nature of surface**. Other surface features may be used to describe the land region adjacent to the coastline (see clause X.X).

A steep coast may give a good radar return and is useful for visual identification from a considerable distance off, particularly where cliffs alternate with low lying coast along the shoreline.

Remarks:

- **Coastline** must only exist at the boundary of **Land Area** of type surface.
- **Coastline** and **Shoreline Construction** of type curve must not overlap. Similarly, **Coastline** should not share an edge with a **Shoreline Construction** of type surface (see clause X.X) having attribute **water level effect** undefined or populated with the values 2 (always dry) or 1 (partly submerged at high water), which is covered by **Land Area**.
- If the seaward edge of an encoded saltpan area is coincident with the coastline, it should be encoded using **Coastline**, with **category of coastline** = 2 (flat coast).
- If the seaward edge of a mangrove area, marsh area or glacier is coincident with the coastline, the coastline should be encoded as **Coastline**, with attribute **category of coastline** = 7 (mangrove), 8 (marshy shore) or 9 (glacier (seaward end)). The coastline's spatial type should have the attribute **quality of horizontal measurement** = 4 (approximate). If it is required to encode the area behind the coastline, this must be done using a **Vegetation** feature (for mangrove and marsh – see clause X.X) or an **Ice Area** feature (for glacier – see clause X.X).
- Where the source indicates the top of a cliff is coincident with the coastline at the maximum display scale of the ENC data, a **Coastline** feature, with **category of coastline** = 1 (steep coast) should be encoded. In such cases, there should be no **Slope Topline** or **Sloping Ground** features encoded, in order to avoid clutter. If it is required to indicate that such a section of the coastline provides a good radar return, it must be done using attribute **radar conspicuous** on the **Coastline** feature. If it is required to encode a section of the coastline that is visually conspicuous, it must be done using attribute **visually conspicuous** on the **Coastline** feature.
- If the source indicates that the top of a coastal cliff is offset inshore from the coastline at the maximum display scale of the ENC data, a **Slope Topline** feature (see clause X.X) and/or a **Sloping Ground** feature (see clause X.X) may be encoded. In such cases, the **Coastline** feature should not have a value populated for **category of coastline**. If it is required to indicate that such a section of the coastline provides a good radar return, it must be done using attribute **radar conspicuous** on the **Slope Topline** and/or **Sloping Ground** feature. If it is required to encode a section of the coastline that is visually conspicuous, it must be done using attribute **visually conspicuous** on the **Slope Topline** and/or **Sloping Ground** feature.

Distinction: Shoreline construction; slope topline; sloping ground.

5.4 Land area

IHO Definition: **LAND AREA.** The solid portion of the Earth's surface, as opposed to sea, water. (IHO Dictionary – S-32).

S-101 Geo Feature: Land area (LNDARE)

Primitives: Point, Curve, Surface

Real World

Paper Chart Symbol

ECDIS Symbol

S-101 Attribute	S-57 Acronym	Allowable Encoding Value	Type	Multiplicity
Condition	(CONDTN)	1 : under construction 3 : under reclamation 5 : planned construction	EN	0,1
Feature name			C	0,*
Display name			(S) BO	0,1
Language		ISO 639-3	(S) TE	0,1
Name	(OBJNAM) (NOBJNM)		(S) TE	1,1
Status	(STATUS)	18 : existence doubtful	EN	0,1
Scale minimum	(SCAMIN)	See clause X.X	IN	0,1

INT 1 Reference: K 10

5.4.1 Land area

Land areas that are never covered by the sea must be encoded using the feature **Land Area**. **Land Area** features of type surface are part of the Skin of the Earth.

Rivers, canals, lakes, basins and docks, which are not navigable at the maximum display scale for the ENC data, must be encoded on top of **Land Area** features (see clause X.X).

Remarks:

- If it is required to describe the natural scenery of the land, it must be done using the feature **Land Region** (see clause X.X).
- **Land Area** is usually of type surface; it may, however, be of type point (for example islet, rock that does not cover), or of type curve (for example islet, offshore bar, isthmus).
- **Land Area** of type curve or point must not be encoded on top of **Land Area** of type surface, unless it is also covered by a **Lake, River, Dock Area, Lock Basin** or **Canal** feature of type surface.
- The limits of a **Land Area** of type surface must share the geometry of at least one of the following features:
 - **Coastline, Shoreline Construction, Gate, Dam** of type curve;
 - **Data Coverage, Gate, Dam, River, Tunnel, Dry Dock, Canal, Lake, Lock Basin, Dock Area, Land Area** of type surface;
 - **Causeway, Shoreline Construction, Mooring/Warping Facility, Wreck, Obstruction, Pylon/Bridge Support** of type surface; and having attribute **water level effect** = 1 (partly submerged at high water), 2 (always dry) or 6 (subject to inundation or flooding).

5.4.2 Rocks which do not cover (islets) (see S-4 – B-421.1)

A surface feature must be encoded using:

- A **Land Area** feature of type surface (mandatory)
- **Coastline** or **Shoreline Construction** features of type curve (mandatory)
- **Land Elevation** features of type curve and/or point (optional)

A curve feature must be encoded using:

- A **Land Area** feature of type curve (mandatory)
- **Land Elevation** features of type point (optional)

A point feature must be encoded using:

- A **Land Area** feature of type point (mandatory)
- A **Land Elevation** feature of type point (optional)

Distinction: Canal; coastline; depth area; lake; land region; river; seabed area; shoreline construction; vegetation.

Feature/Information associations							
Type	Association Name	Association Ends					
		Class	Role	Mult	Class	Role	Mult
Aggr	Island Aggregation	Land Area	Consists of	2,*	Island Group	Component of	0,1

5.5 Island group

IHO Definition: **ISLAND GROUP**. A named group of islands, including archipelago's.

S-101 Geo Feature: Island group

Primitives: None

<i>Real World</i>	<i>Paper Chart Symbol</i>	<i>ECDIS Symbol</i>
-------------------	---------------------------	---------------------

S-101 Attribute	S-57 Acronym	Allowable Encoding Value	Type	Multiplicity
Feature name			C	0,*
Display name			(S) BO	0,1
Language		ISO 639-3	(S) TE	0,1
Name	(OBJNAM) (NOBJNM)		(S) TE	1,1

INT 1 Reference:

5.5.1 Island groups

If it is required to encode the name of a group of islands, it must be done using the named aggregation **Island Group**, with all relevant **Land Area** features (see clause X.X) included in the aggregation.

Remarks:

- Names of individual islands within an island group must be encoded using the attribute **feature name** on the relevant **Land Area** feature.

Distinction: Land area; land region.

Feature/Information associations

Type	Association Name	Association Ends					
		Class	Role	Mult	Class	Role	Mult
Aggr	Island Aggregation	Island Group	Component of	0,1	Land Area, Island Group	Consists of	2,*

5.6 Land elevation

IHO Definition: **LAND ELEVATION.** An elevation is the vertical distance of a point or a level, on, or affixed to, the surface of the earth, measured from a specified vertical datum. (Adapted from IHO Dictionary – S-32).

S-101 Geo Feature: Land elevation (LNDELV)

Primitives: Point, Curve

Real World

Paper Chart Symbol

ECDIS Symbol

S-101 Attribute	S-57 Acronym	Allowable Encoding Value	Type	Multiplicity
Elevation	(ELEVAT)		RE	1,1
Feature name			C	0,*
Display name			(S) BO	0,1
Language		ISO 639-3	(S) TE	0,1
Name	(OBJNAM) (NOBJNM)		(S) TE	1,1
Visually conspicuous	(CONVIS)	1 : visually conspicuous 2 : not visually conspicuous 3 : prominent	EN	0,1
Scale minimum	(SCAMIN)	See clause X.X	IN	0,1

INT 1 Reference: C 10-13

5.6.1 Height contours, spot heights (see S-4 – B-351 and B-352.1-2)

It is assumed that mariners will understand most methods of representation of relief with little difficulty. In general it is assumed that Producing Authorities will choose the representation of relief most suitable to the terrain being charted and the navigational requirements. It is therefore left to national discretion to:

- omit all relief representation, except dykes and sea walls;
- omit all relief representation, except spot heights and cliffs;
- show relief by contours (and spot heights); or
- show relief by form lines (and spot heights).

Spot heights on ENC datasets should be confined to summits of hills, mountains and cliffs, particularly on datasets from which contours and form lines have been omitted; navigators will generally assume that heights selected for ENC are summits.

If it is required to encode a height contour or spot height, it must be done using the feature **Land Elevation**.

Land Elevation features must be covered by a **Land Area** feature of type surface, or a **Wreck** feature of type surface having attribute **water level effect** = 1 (partially submerged at high water) or 2 (always dry), or fall on a **Land Area** feature of type curve, or share the geometry of a **Land Area** of type point or a **Wreck** feature of type point having attribute **water level effect** = 1 (partially submerged at high water) or 2 (always dry).

Spatial types associated with approximate contours or spot heights should be encoded using the attribute **quality of horizontal measurement** = 4 (approximate).

Remarks:

- Where it would not be worthwhile to contour ENC data of smaller maximum display scale, form lines (emphasizing a few 'remarkable' hills) and/or spot heights may be used to emphasize individual features.
- Contours should reflect the nature of the topography; that is, they should not be rounded or smoothed (by generalisation) when they should really be angular.
- The contour interval must be uniform for any dataset, or series of datasets of the same or similar maximum display scale, except that the lowest contour may be a supplementary one, for example 25 metres where

the basic interval is every 50 metres, or 10 metres where the basic interval is every 25 metres. Ideally the contour interval should be chosen so that not more than 10 contours are needed for the full range of height on a single dataset or particular series of datasets (for clarity and economy).

Distinction: Slope topline; sloping ground.

5.7 River

IHO Definition: **RIVER.** A relatively large natural stream of water. (IHO Dictionary – S-32)

S-101 Geo Feature: River (RIVERS)

Primitives: Curve, Surface

Real World

Paper Chart Symbol

ECDIS Symbol

S-101 Attribute	S-57 Acronym	Allowable Encoding Value	Type	Multiplicity
Feature name			C	0,*
Display name			(S) BO	0,1
Language		ISO 639-3	(S) TE	0,1
Name	(OBJNAM) (NOBJNM)		(S) TE	1,1
Status	(STATUS)	5 : periodic/intermittent	EN	0,1
Scale minimum	(SCAMIN)	See clause X.X	IN	0,1

INT 1 Reference: C 20, 21

5.7.1 Rivers (see S-4 – B-353)

Inland navigable waters must be compiled as fully as practicable, consistent with the maximum display scale of the ENC data. Other rivers should be compiled only in a limited way to assist in providing a general indication of the topography (except close to the coastline where they may be of direct significance to the mariner).

If it is required to encode a non-navigable river, stream or creek, it must be done using the feature **River**.

Remarks:

- If the river is navigable at the maximum display scale for the ENC data, it must be encoded using the feature **Depth Area**, **Dredged Area** (see clause X.X) or **Unsurveyed Area**, and the riverbanks must be encoded using the feature **Coastline** or **Shoreline Construction**. The river must not be encoded as a **River** feature in this case. If it is required to encode the name of the river, it must be done using a **Sea Area/Named Water Area** feature with attribute **category of sea area** = 53 (river).
- Where the river is navigable at the maximum display scale for the ENC data, special consideration should be given to encoding features specific to the river such as minimum depths within the navigable area; overhead clearances; distances along the river; and locks and lock gates (and any associated traffic signals).
- If it is required to encode a river that is not navigable at the maximum display scale for the ENC data, it must be done using **River**, covered by a **Land Area** feature. The name of the river should be encoded using the complex attribute **feature name** on the **River** feature.
- Intermittent rivers are those that are dry most of the time, and where required must be encoded as a **River** feature with attribute **status** = 5 (periodic/intermittent).
- If it is required to encode an island in a non-navigable river encoded on **Land Area**, this must be done by encoding a “hole” in the **River** feature if the island is a surface at the maximum display scale for the ENC data, or encoding **Land Area** of type point if the island is a point at the maximum display scale for the ENC data. Encoders must not encode **Land Area** surfaces on top of **Land Area** surfaces. If it is required to encode an island in a non-navigable river encoded on **Unsurveyed Area**, this must be done by encoding a “hole” in both the **River** and **Unsurveyed Area** features and replacing with **Land Area** if the island is a surface at the maximum display scale for the ENC data, or encoding **Land Area** of type point if the island is a point at the maximum display scale for the ENC data. Encoders must not encode **Land Area** surfaces on top of **Unsurveyed Area** surfaces.

- Some dry riverbeds, known as wadi's, may be prominent topographic features. If it is required to encode a wadi, it should be done using a **Land Region** feature (see clause X.X), with the name of the wadi encoded using the complex attribute **feature name**.

Distinction: Canal; lake; sea area/named water area; tideway.

5.8 Rapids

IHO Definition: **RAPID(S)**. Portions of a stream with accelerated current where it descends rapidly but without a break in the slope of the bed sufficient to form a waterfall. Usually used in the plural. (IHO Dictionary – S-32).

S-101 Geo Feature: Rapids (RAPIDS)

Primitives: Point, Curve, Surface

Real World

Paper Chart Symbol

ECDIS Symbol

S-101 Attribute	S-57 Acronym	Allowable Encoding Value	Type	Multiplicity
Feature name			C	0,*
Display name			(S) BO	0,1
Language		ISO 639-3	(S) TE	0,1
Name	(OBJNAM) (NOBJNM)		(S) TE	1,1
Vertical length	(VERLEN)		RE	0,1
Scale minimum	(SCAMIN)	See clause X.X	IN	0,1

INT 1 Reference: C 22

5.8.1 Rapids (see S-4 – B-353.5)

If it is required to encode rapids within a river, it must be done using the feature **Rapids**.

Remarks:

- The area covered by rapids must also be covered by a **River** feature (see clause X.X) and a **Land Area** feature if there is no navigable water adjoining the **Rapids**; or an **Unsurveyed Area** feature if there is navigable water adjacent to the **Rapids**.

Distinction: Current – non-gravitational; river; tidal stream panel data; water turbulence; waterfall.

5.9 Waterfall

IHO Definition: **WATERFALL.** A vertically descending part of a watercourse where it falls from a height (for example: over a rock or a precipice). In place names, commonly shortened to “fall” or “falls”, for example “Niagara Falls”. (Defence Geospatial Information Working Group; Feature Data Dictionary Register, 2010).

S-101 Geo Feature: Waterfall (WATFAL)

Primitives: Point, Curve

Real World

Paper Chart Symbol

ECDIS Symbol

S-101 Attribute	S-57 Acronym	Allowable Encoding Value	Type	Multiplicity
Feature name			C	0,*
Display name			(S) BO	0,1
Language		ISO 639-3	(S) TE	0,1
Name	(OBJNAM) (NOBJNM)		(S) TE	1,1
Vertical length	(VERLEN)		RE	0,1
Visually conspicuous	(CONVIS)	1 : visually conspicuous 2 : not visually conspicuous 3 : prominent	EN	0,1
Scale minimum	(SCAMIN)	See clause X.X	IN	0,1

INT 1 Reference: C 22

5.9.1 Waterfalls (see S-4 – B-353.5)

If it is required to encode a waterfall within a river, it must be done using the feature **Waterfall**.

Remarks:

- The area covered by a waterfall must also be covered by a **River** feature (see clause X.X) and a **Land Area**.

Distinction: Rapids; river.

5.10 Lake

<u>IHO Definition:</u> LAKE . A large body of water entirely surrounded by land. (IHO Dictionary – S-32).				
S-101 Geo Feature: Lake (LAKARE)				
Primitives: Surface				
<i>Real World</i>		<i>Paper Chart Symbol</i>		<i>ECDIS Symbol</i>
S-101 Attribute	S-57 Acronym	Allowable Encoding Value	Type	Multiplicity
Elevation	(ELEVAT)		RE	0,1
Feature name			C	0,*
Display name			(S) BO	0,1
Language		ISO 639-3	(S) TE	0,1
Name	(OBJNAM) (NOBJNM)		(S) TE	1,1
Scale minimum	(SCAMIN)	See clause X.X	IN	0,1
Status	(STATUS)	5 : periodic/intermittent	EN	0,1
<u>INT 1 Reference:</u> C 23				
5.10.1 Lakes (see S-4 – B-353.6)				
Inland navigable waters must be compiled as fully as practicable, consistent with the maximum display scale of the ENC data. Other lakes should be compiled only in a limited way to assist in providing a general indication of the topography (except close to the coastline where they may be of direct significance to the mariner).				
If it is required to encode a non-navigable lake, it must be done using the feature Lake .				
<u>Remarks:</u>				
<ul style="list-style-type: none"> • If the lake is navigable at the maximum display scale for the ENC data, it must be encoded using the feature Depth Area, Dredged Area (see clause X.X) or Unsurveyed Area, and the lake shore must be encoded using the feature Coastline or Shoreline Construction. The lake must not be encoded as a Lake feature in this case. If it is required to encode the name of the lake, it must be done using a Sea Area/Named Water Area feature, with attribute category of sea area = 52 (lake). • If it is required to encode a lake that is not navigable at the maximum display scale for the ENC data, it must be done using Lake, covered by a Land Area feature. The name of the lake should be encoded using the complex attribute feature name on the Lake feature. • If it is required to encode an island in a non-navigable lake encoded on Land Area, this must be done by encoding a “hole” in the Lake feature if the island is a surface at the maximum display scale for the ENC data, or encoding Land Area of type point if the island is a point at the maximum display scale for the ENC data. Encoders must not encode Land Area surfaces on top of Land Area surfaces. If it is required to encode an island in a non-navigable lake encoded on Unsurveyed Area, this must be done by encoding a “hole” in both the Lake and Unsurveyed Area features and replacing with Land Area if the island is a surface at the maximum display scale for the ENC data, or encoding Land Area of type point if the island is a point at the maximum display scale for the ENC data. Encoders must not encode Land Area surfaces on top of Unsurveyed Area surfaces. • Intermittent lakes are those that are dry most of the time, and where required must be encoded as a Lake feature with attribute status = 5 (periodic/intermittent). 				
<u>Distinction:</u> Canal; depth area; river.				

5.11 Land region

IHO Definition: **LAND REGION.** An area of natural or cultivated scenery defined by its geographical characteristics and may be known by its proper name. (Adapted from S-57 Edition 3.1, Appendix A – Chapter 1, Page 1.92, November 2000).

S-101 Geo Feature: Land region (LNDRGN)

Primitives: Point, Curve, Surface

Real World

Paper Chart Symbol

ECDIS Symbol

S-101 Attribute	S-57 Acronym	Allowable Encoding Value	Type	Multiplicity
Category of land region	(CATLND)	1 : fen 2 : marsh 3 : moor/bog 4 : heathland 5 : mountain range 6 : lowlands 7 : canyon lands 8 : paddy field 9 : agricultural land 10 : savanna/grassland 11 : parkland 12 : swamp 13 : landslide 14 : lava flow 15 : salt pan 16 : moraine 17 : crater 18 : cave 19 : rock column or pinnacle 20 : cay	EN	0,*
Feature name			C	0,*
Display name			(S) BO	0,1
Language		ISO 639-3	(S) TE	0,1
Name	(OBJNAM) (NOBJNM)		(S) TE	1,1
Nature of surface	(NATSUR)	1 : mud 2 : clay 3 : silt 4 : sand 5 : stone 6 : gravel 7 : pebbles 8 : cobbles 9 : rock 11 : lava 14 : coral 17 : shells 18 : boulder	EN	0,*
Water level effect	(WATLEV)	1 : partly submerged at high water 6 : subject to inundation or flooding	EN	0,1

Scale minimum	(SCAMIN)	See clause X.X	IN	0,1
<p><u>INT 1 Reference:</u> C 24, 26, 33</p> <p>5.11.1 Natural sceneries (see S-4 – B-350)</p> <p>If it is required to describe the natural scenery of the land, or to give the geographic name of an area on land (see clause X.X), it should be encoded using the feature Land Region.</p> <p><u>Remarks:</u></p> <ul style="list-style-type: none"> • This feature has a use similar to that of the feature Sea Area/Named Water Area (see clause X.X), but for the land. • Sand dunes, hills and cliffs must be encoded, where required, using the feature classes Sloping Ground and/or Slope Topline (see clauses X.X and X.X) • At least one of the attributes category of land region or feature name must be populated. • A Land Region surface should be bounded, if possible, by existing curves used by other features (for example Coastline). If necessary, however, this surface may be bounded by other curves created to close the surface, or to describe a new surface. • For named capes, points, peninsulas and other types of Land Region where there is no specific value for the attribute category of land region, the generic term “Cape”, “Point”, “Peninsula”, etc may be included on the complex attribute feature name, unless the name has been populated on an underlying Land Area, in which case Land Region should not be encoded. • Land Region features of type surface may overlap. • For additional guidance on encoding geographic names, see clause X.X. <p>5.11.1.1 Marsh (see S-4 – B-312.2)</p> <p>If it is required to encode a marshy area behind the coastline, it must be done using a Land Region feature, with attribute category of land region = 2 (marsh).</p> <p>If the seaward edge of a marsh area is coincident with the coastline, the coastline should be encoded as a Coastline feature, with attribute category of coastline = 8 (marshy shore), and the coastline’s spatial type should have the attribute quality of horizontal measurement = 4 (approximate) for the visible coastline.</p> <p>5.11.1.2 Salt pans (see S-4 – B-353.7)</p> <p>If it is required to encode an area on land in which seawater is evaporated, it must be done using a Land Region feature, with attribute category of land region = 15 (salt pan) covered by a Land Area feature (that is, the salt pan must not form a hole in the land area).</p> <p>If the seaward edge of an encoded salt pan area is coincident with the coastline, this edge should also be encoded using a Coastline feature, with attribute category of coastline = 2 (flat coast).</p> <p>5.11.1.3 Lava flow (see S-4 – B-355)</p> <p>If it is required to encode a lava flow, it must be done using a Land Region feature, with attribute category of land region = 14 (lava flow).</p> <p>If the seaward edge of an encoded lava flow area is coincident with the coastline, this edge should also be encoded using a Coastline feature (see clause X.X), with attribute nature of surface = 11 (lava). If the source indicates that the lava flow is active, the coastline’s spatial type should have the attribute quality of horizontal measurement = 4 (approximate).</p> <p><u>Distinction:</u> Land area; sea area/named water area; slope topline; sloping ground; vegetation.</p>				

5.12 Vegetation

IHO Definition: **VEGETATION.** Plants collectively or individually, especially those dominating a particular area or habitat. (Adapted from Defence Geospatial Information Working Group; Feature Data Dictionary Register, 2010).

S-101 Geo Feature: Vegetation (VEGATN)

Primitives: Point, Curve, Surface

Real World

Paper Chart Symbol

ECDIS Symbol

S-101 Attribute	S-57 Acronym	Allowable Encoding Value	Type	Multiplicity
Category of vegetation	(CATVEG)	3 : bush 4 : deciduous wood 5 : coniferous wood 6 : wood in general (inc. mixed wood) 7 : mangroves 11 : reed 13 : tree in general 14 : evergreen tree 15 : conifer tree 16 : palm tree 17 : nipa palm tree 18 : casuarinas tree 19 : eucalypt tree 20 : deciduous tree 21 : mangrove tree 22 : filao tree	EN	1,1
Elevation	(ELEVAT)		RE	0,1
Feature name			C	0,*
Display name			(S) BO	0,1
Language		ISO 639-3	(S) TE	0,1
Name	(OBJNAM) (NOBJNM)		(S) TE	1,1
Height	(HEIGHT)		RE	0,1
Vertical length	(VERLEN)		RE	0,1
Visually conspicuous	(CONVIS)	1 : visually conspicuous 2 : not visually conspicuous 3 : prominent	EN	0,1
Scale minimum	(SCAMIN)	See clause X.X	IN	0,1

INT 1 Reference: C 14, 30, 31.1-8, 32, 33

5.12.1 Vegetation (see S-4 – B-312.4; B-352.4 and B-354)

In most areas the vegetation cover is of negligible importance on charts with the exception of:

- Areas where trees or marsh form the apparent coastline; see S-4 – B-312;
- Isolated trees or clumps of trees forming landmarks;
- Where, near the coast, wooded areas alternate with areas without tree cover and so may assist in identifying headlands or other stretches of coastline.

The following features should be omitted from even the largest maximum display scale ENC data:

- Grassland, cultivated fields (including paddy fields), bushes.
- Trees along roads, fences, ditches, and scattered trees (unless landmarks).
- Woodland cover within urban areas (unless adjacent to the coast).
- Woodland cover which is the general ground cover and therefore useless for identification of position.

If it is required to encode an isolated tree used as a landmark, it must be done using a **Vegetation** feature, with attribute **category of vegetation** = 13 to 22.

If it is required to encode a mangrove area, it must be done using a **Vegetation** feature, with **category of vegetation** = 7 (mangroves).

Remarks:

- The attribute **height** is used to encode the approximate altitude of the highest point of the top of the vegetation. Where the source shows an island with the approximate height of the top of the vegetation above height datum (see INT1 - C14), a **Vegetation** feature should be encoded co-incident with the **Land Area** feature of the island, with attribute **height** corresponding to the value shown on the source.
- Where the source indicates that a mangrove area is in the intertidal area, a **Vegetation** feature, with attribute **category of vegetation** = 7 (mangroves) should be encoded on top of the intertidal area (**Depth Area** with attributes **depth range minimum value** = $-H$ and **depth range maximum value** = 0 – see clause X.X). The seaward spatial type(s) of the mangrove area should have the attribute **quality of horizontal measurement** = 4 (approximate). The landward edge of the mangrove area should be encoded as **Coastline** (see clause X.X), having no value populated for the attribute **category of coastline**, and no value for **quality of horizontal measurement** on the related spatial type(s).

Distinction: Seabed area; weed/kelp.

5.13 Ice area

IHO Definition: **ICE AREA.** An area of ice over land or water. (S-57 Edition 3.1, Appendix A – Chapter 1, Page 1.84, November 2000).

S-101 Geo Feature: Ice area (ICEARE)

Primitives: Surface

Real World

Paper Chart Symbol

ECDIS Symbol

S-101 Attribute	S-57 Acronym	Allowable Encoding Value	Type	Multiplicity
Category of ice	(CATICE)	1 : fast ice 5 : glacier 8 : polar ice	EN	1,1
Elevation	(ELEVAT)		RE	0,1
Feature name			C	0,*
Display name			(S) BO	0,1
Language		ISO 639-3	(S) TE	0,1
Name	(OBJNAM) (NOBJNM)		(S) TE	1,1
Height	(HEIGHT)		RE	0,1
Periodic date range			C	0,*
Date end	(PEREND)	ISO 8601:2004	(S) TD	1,1
Date start	(PERSTA)	ISO 8601: 2004	(S) TD	1,1
Reported date	(SORDAT)	ISO 8601: 2004	TD	0,1
Status	(STATUS)	1 : permanent 5 : periodic/intermittent 18 : existence doubtful	EN	0,*
Vertical length	(VERLEN)		RE	0,1
Visually conspicuous	(CONVIS)	1 : visually conspicuous 2 : not visually conspicuous 3 : prominent	EN	0,1
Scale minimum	(SCAMIN)	See clause X.X	IN	0,1

INT 1 Reference: C 25; N 60.1-2

5.13.1 Ice areas (see S-4 – B-353.8 and B-449.1)

If it is required to encode an ice area, it must be done using the feature **Ice Area**.

Remarks:

- **Ice Area** features that are located in the sea must be covered by an **Unsurveyed Area** feature, if the depth of water beneath them is unknown, or covered by a **Depth Area** feature, if the depth is known.
- As ice fronts move, a date when the limit was surveyed should be included, if possible, using the attribute **reported date**.

5.13.1.1 Glaciers (see S-4 – B-353.8)

If it is required to encode the portion of a glacier that is on land, it must be done using an **Ice Area** feature, with attribute **category of ice** = 5 (glacier) covered by a **Land Area** feature (that is, the glacier does not form a

hole in the land area).

If the seaward edge of an encoded glacier is coincident with the coastline, this edge should be encoded using a **Coastline** feature, with attribute **category of coastline** = 6 (glacier (seaward end)), and the coastline's spatial type should have the attribute **quality of horizontal measurement** = 4 (approximate) for the visible coastline.

Distinction: Depth area; land area.

5.14 Sloping ground

<u>IHO Definition:</u> SLOPING GROUND . An inclined surface. (Adapted from IHO Dictionary – S-32).				
S-101 Geo Feature: Sloping ground (SLOGRD)				
Primitives: Point, Surface				
<i>Real World</i>		<i>Paper Chart Symbol</i>		<i>ECDIS Symbol</i>
S-101 Attribute	S-57 Acronym	Allowable Encoding Value	Type	Multiplicity
Category of slope	(CATSLO)	1 : cutting 2 : embankment 3 : dune 4 : hill 5 : pingo 6 : cliff 7 : scree	EN	0,1
Colour	(COLOUR)	1 : white 2 : black 3 : red 4 : green 6 : yellow 7 : grey 8 : brown 11 : orange 13 : pink	EN	0,*
Feature name			C	0,*
Display name			(S) BO	0,1
Language		ISO 639-3	(S) TE	0,1
Name	(OBJNAM) (NOBJNM)		(S) TE	1,1
Nature of surface	(NATSUR)	4 : sand 5 : stone 6 : gravel 7 : pebbles 9 : rock 11 : lava	EN	0,*
Radar conspicuous	(CONRAD)		BO	0,1
Visually conspicuous	(CONVIS)	1 : visually conspicuous 2 : not visually conspicuous 3 : prominent	EN	0,1
Scale minimum	(SCAMIN)	See clause X.X	IN	0,1
<u>INT 1 Reference:</u> C 3, 4, 8; D 14, 15				
5.14.1 Sloping ground (see S-4 – B-312.1; B-312.3; B-363.2 and B-364.1)				
If it is required to encode the characteristics of a prominent or visually conspicuous inclined land surface, it must be done using the feature Sloping Ground .				
<u>Remarks:</u>				
<ul style="list-style-type: none"> • Sloping Ground of type surface that are not radar conspicuous (that is, radar conspicuous not 				

populated)) and having attribute **category of slope** = 1 (cutting), 2 (embankment), 3 (dune), 4 (hill), 5 (pingo) or 7 (scree) do not symbolise in the ECDIS. Where it is required to encode such areas, alternative features such as **Landmark** or **Vegetation** should be used.

5.14.1.1 Dunes, sand hills (see S-4 – B-312.3)

If it is required to encode a sand dune or sand hill, it must be done using the feature **Sloping Ground** with attribute **category of slope** = 3 (dune) or 4 (hill) and attribute **nature of surface** = 4 (sand). If these features are positioned along the coastline, a **Coastline** feature must also be encoded.

If it is required to encode the height of a dune or sand hill, a **Land Elevation** feature (see clause X.X) must also be encoded.

Distinction: Land elevation; slope topline.

5.15 Slope topline

IHO Definition: **SLOPE TOPLINE.** The upper marking of a slope, for example the ridge line or the separation line between two different gradients. (S-57 Edition 3.1, Appendix A – Chapter 1, Page 1.160, November 2000).

S-101 Geo Feature: Slope topline (SLOTOP)

Primitives: Curve

Real World

Paper Chart Symbol

ECDIS Symbol

S-101 Attribute	S-57 Acronym	Allowable Encoding Value	Type	Multiplicity
Category of slope	(CATSLO)	1 : cutting 2 : embankment 6 : cliff	EN	0,1
Colour	(COLOUR)	1 : white 2 : black 3 : red 4 : green 6 : yellow 7 : grey 8 : brown 11 : orange 13 : pink	EN	0,*
Elevation	(ELEVAT)		RE	0,1
Feature name			C	0,*
Display name			(S) BO	0,1
Language		ISO 639-3	(S) TE	0,1
Name	(OBJNAM) (NOBJNM)		(S) TE	1,1
Nature of surface	(NATSUR)	4 : sand 5 : stone 6 : gravel 7 : pebbles 9 : rock 11 : lava	EN	0,*
Radar conspicuous	(CONRAD)		BO	0,1
Visually conspicuous	(CONVIS)	1 : visually conspicuous 2 : not visually conspicuous 3 : prominent	EN	0,1
Scale minimum	(SCAMIN)	See clause X.X	IN	0,1

INT 1 Reference: C 3; D 14, 15

5.15.1 Slope topline (see S-4 – B-312.1; B-363.2 and B-364.1)

If it is required to encode the upper marking of a prominent or visually conspicuous land slope, it must be done using the feature **Slope Topline**.

Remarks:

- No remarks.

Distinction: Land elevation; sloping ground.

5.16 Tideway

IHO Definition: TIDEWAY. A natural water course in intertidal areas where water flows during the ebb or flow. (S-57 Edition 3.1, Appendix A – Chapter 1, Page 1.181, November 2000).

S-101 Geo Feature: Tideway (TIDEWY)

Primitives: Curve, Surface

Real World

Paper Chart Symbol

ECDIS Symbol

S-101 Attribute	S-57 Acronym	Allowable Encoding Value	Type	Multiplicity
Feature name			C	0,*
Display name			(S) BO	0,1
Language		ISO 639-3	(S) TE	0,1
Name	(OBJNAM) (NOBJNM)		(S) TE	1,1
Scale minimum	(SCAMIN)	See clause X.X	IN	0,1

INT 1 Reference:

5.16.1 Tideways (see S-4 – B-413.3)

If it is required to encode a natural watercourse in intertidal areas, for example formed by the outflow of a stream or by tidal action, it must be done using the feature **Tideway**.

Remarks:

- No remarks.

Distinction: Canal; river; sea area/named water area.

6 Geo Features – Cultural Features

6.1 Built-up area

IHO Definition: **BUILT-UP AREA.** An area of land containing a concentration of buildings and/or other structures. (Adapted from Defence Geospatial Information Working Group; Feature Data Dictionary Register, 2010).

S-101 Geo Feature: Built-up area (BUAARE)

Primitives: Point, Surface

Real World

Paper Chart Symbol

ECDIS Symbol

S-101 Attribute	S-57 Acronym	Allowable Encoding Value	Type	Multiplicity
Category of built-up area	(CATBUA)	1 : urban area 2 : settlement 3 : village 4 : town 5 : city 6 : holiday village	EN	0,1
Condition	(CONDTN)	1 : under construction 2 : ruined 5 : planned construction	EN	0,1
Feature name			C	0,*
Display name			(S) BO	0,1
Language		ISO 639-3	(S) TE	0,1
Name	(OBJNAM) (NOBJNM)		(S) TE	1,1
Height	(HEIGHT)		RE	0,1
Radar conspicuous	(CONRAD)		BO	0,1
Reported date	(SORDAT)	ISO 8601: 2004	TD	0,1
Visually conspicuous	(CONVIS)	1 : visually conspicuous 2 : not visually conspicuous 3 : prominent	EN	0,1
Scale minimum	(SCAMIN)	See clause X.X	IN	0,1

INT 1 Reference: D 1-4

6.1.1 Built-up areas (see S-4 – B-370.3-4 and B-370.6-7)

When representing built-up areas, the aim of the compiler must be to create the correct impression of the extent of the built-up area.

If it is required to encode a built-up area, it must be done using the feature **Built-Up Area**.

Remarks:

- A built-up area crossed by curve features (for example roads, streets, railways) should not be divided into multiple features, unless separate sections of the built-up area have at least one different attribute value.
- However, for presentation purposes, a built up area of type surface crossed by a river or canal of type surface must be divided into several features, with the built-up area features not overlapping the river or canal feature. A built up area of type surface should not overlap a lake, dock or lock basin feature of type surface.

- Several buildings or built-up areas may be referred to by the same settlement, village or town name on the source. In such cases, the individual buildings or built-up areas should be encoded as separate unnamed features, using the features **Building** or **Built-Up Area**, and additionally, an **Administration Area** feature (see clause X.X) covering the whole named area should be created with the name encoded using the attribute **feature name**. The encoded **Administration Area** feature should also have the attribute **jurisdiction** = 3 (national sub-division).
- **Built-Up Area** should be covered by **Land Area** features of type surface, or be coincident with **Land Area** features of type point.
- Where the source indicates that a built-up area extends into navigable water (over **Depth Area** or **Unsurveyed Area** object(s)), an encoded **Built-Up Area** feature of type area, where required, should be extended over the water area. The seaward edge of the built-up area (“apparent” coastline) must be encoded using a **Coastline** feature having no value populated for the attribute **category of coastline**, and the corresponding spatial edge(s) should have the spatial attribute **quality of position** = 4 (approximate). The actual coastline should be encoded as **coastline**, having no value populated for **category of coastline** and no value for **quality of position** on the related spatial edge(s). Underlying bathymetry (depth contours, soundings) should be encoded as required. Exceptionally, encoders may extend the underlying **Land Area** feature seaward to the “apparent” coastline, which should have the corresponding spatial edge(s) populated with the spatial attribute **quality of position** = 4 (approximate). This encoding should be considered for generalization purposes on smaller scale ENC’s.
- For encoding individual buildings over navigable water, see clause X.X.

Distinction: Building single; landmark; railway; road.

6.2 Building, single

IHO Definition: BUILDING. A free-standing self-supporting construction that is roofed, usually walled, and is intended for human occupancy (for example: a place of work or recreation) and/or habitation. (Defence Geospatial Information Working Group; Feature Data Dictionary Register, 2010).

S-101 Geo Feature: Building (BUISGL)

Primitives: Point, Surface

Real World

Paper Chart Symbol

ECDIS Symbol

S-101 Attribute	S-57 Acronym	Allowable Encoding Value	Type	Multiplicity
Building shape	(BUIHP)	5 : high-rise building 6 : pyramid 7 : cylindrical 8 : spherical 9 : cubic	EN	0,1
Colour	(COLOUR)	1 : white 2 : black 3 : red 4 : green 5 : blue 6 : yellow 7 : grey 8 : brown 9 : amber 10 : violet 11 : orange 12 : magenta 13 : pink	EN	0,* (ordered)
Colour pattern	(COLPAT)	1 : horizontal stripes 2 : vertical stripes 3 : diagonal stripes 4 : squared 5 : stripes (direction unknown) 6 : border stripe	EN	0,1
Condition	(CONDTN)	1 : under construction 2 : ruined 5 : planned construction	EN	0,1
Elevation	(ELEVAT)		RE	0,1
Feature name			C	0,*
Display name			(S) BO	0,1
Language		ISO 639-3	(S) TE	0,1
Name	(OBJNAM) (NOBJNM)		(S) TE	1,1
Function	(FUNCTN)	2 : harbour-master's office 3 : custom office 4 : health office 5 : hospital 6 : post office 7 : hotel 8 : railway station	EN	0,*

		9 : police station 10 : water-police station 11 : pilot office 12 : pilot lookout 13 : bank office 14 : headquarters for district control 15 : transit shed/warehouse 16 : factory 17 : power station 18 : administrative 19 : educational facility 20 : church 21 : chapel 22 : temple 23 : pagoda 24 : Shinto shrine 25 : Buddhist temple 26 : mosque 27 : marabout 28 : lookout 29 : communication 30 : television 31 : radio 32 : radar 33 : light support 34 : microwave 35 : cooling 36 : observation 37 : timeball 38 : clock 39 : control 40 : airship mooring 41 : stadium 42 : bus station 44 : sea rescue control 45 : observatory 46 : ore crusher 47 : boathouse 48 : pumping station		
Height	(HEIGHT)		RE	0,1
Multiplicity of features			C	0,1
Multiplicity known			(S) BO	1,1
Number of features			(S) IN	0,1
Nature of construction	(NATCON)	1 : masonry 2 : concreted 6 : wooden 7 : metal 8 : glass reinforced plastic (GRP) 12 : glass	EN	0,*
Status	(STATUS)	4 : not in use 7 : temporary 8 : private 12 : illuminated 13 : historic 14 : public	EN	0,*
Radar conspicuous	(CONRAD)		BO	0,1
Reported date	(SORDAT)	ISO 8601: 2004	TD	0,1
Vertical clearance fixed			C	0,1

Vertical clearance value	(VERCLR)		(S) RE	1,1
Vertical uncertainty	(VERACC)		(S) C	0,1
Uncertainty fixed			(S) RE	1,1
Uncertainty variable			(S) RE	0.1
Vertical datum	(VERDAT)	3 : Mean sea level 16 : Mean high water 17 : Mean high water springs 18 : High water 19 : Approximate mean sea level 20 : High water springs 21 : Mean higher high water 24 : Local datum 25 : International great lakes datum 1985 26 : Mean water level 28 : Higher high water large tide 29 : Nearly highest high water 30 : Highest astronomical tide (HAT)	EN	0,1
Vertical length	(VERLEN)		RE	0,1
Visually conspicuous	(CONVIS)	1 : visually conspicuous 2 : not visually conspicuous 3 : prominent	EN	0,1
Scale minimum	(SCAMIN)	See clause X.X	IN	0,1
In the water			BO	0,1

INT 1 Reference: D 5-6, 8, 13; E 10.1, 10.3, 11, 13-18; F 51, 60-63

6.2.1 Buildings (see S-4 – B-325; B-328.1; B-362.2; B-370.3; B-370.5; B-372 and B-373.1-4)

Waterfront, landmark and some public buildings should be encoded precisely and individually on the larger maximum display scale ENC data. When representing buildings generally, forming urban and suburban areas, villages, and other built-up areas, the aim of the compiler must be to create the correct impression of the extent of the built-up area and the density of the buildings.

Within built-up areas, only waterfront, landmark, and certain public buildings of interest should be encoded individually.

Scattered buildings of no individual importance must be omitted when more than about 1 mile (or 2 kilometres) inland. Nearer the shore they may be generalised by encoding a few representative buildings, sufficient to give the correct impression of building density.

Public buildings, with the possible exception of Post Offices and Hospitals, are charted mainly as visual features or points of reference ashore, not for their interest for particular functions. Except where they could be useful landmarks for navigation, they should be encoded only on largest maximum display scale ENC data.

Buildings constructed as places of worship often form significant landmarks; their size and structure incorporating towers, spires, cupolas, etc often render them conspicuous. These buildings when known to be prominent or conspicuous should be encoded up to several miles inland, with sufficient information to enable them to be easily identified. When the maximum display scale for the ENC data permits, the building should be encoded as a surface feature with attention being drawn to any significant features (landmarks).

If it is required to encode a building (other than a landmark, tank or silo), it must be done using the feature **Building**.

Remarks:

- For landmarks, see clause X.X; for silos, tanks and water towers, see clause X.X. For common encoding combinations, see clause X.X.

- The feature association **Structure/Equipment** (see clause X.X) must only be used with **Building** features if the main purpose of the building is to act as an aid to navigation (for example a lighthouse).
- A ruined building should be encoded in the same way as the feature in good condition, but with attribute **condition** = 2 (ruined).
- For covered boathouses and other buildings that are located in or partially overlap the navigable water area, any associated features should be encoded as they exist in the "real world"; for example jetties as **Shoreline Construction**, pontoons as **Pontoon**, mooring posts as **Mooring/Warping Facility**. The roofed area may be covered by a **Building** feature of type surface, with attribute **function** = 47 (boathouse). If the service being provided by the structure is known, features **Small Craft Facility** (see clause X.X) or **Harbour Facility** (see clause X.X) may also be encoded.
- For buildings located in or over navigable water, the Boolean attribute **in the water** must be set to *True* to indicate that the feature is to be included in the ECDIS Base Display. Where such structures are located over the water it is not required to encode any supporting structures (for example piles, stilts).
- The complex attribute **vertical clearance fixed** must not be populated, unless the building is located over navigable water (that is, attribute **in the water** set to *True*), for example, for boathouses.
- When a building is shown as a surface, indicating its true shape, and it is required to encode a prominent feature such as a tower or spire that is part of the structure, two features must be created (see Figure below):
 - a **Building** feature of type surface for the main building,
 - a **Landmark** feature of type point for the prominent feature.

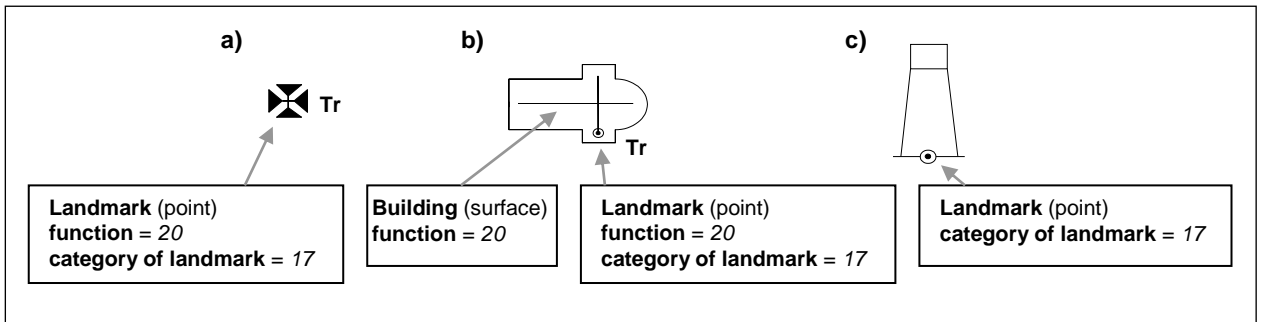

6.2.2 Harbour offices (see S-4 – B-325)

If it is required to encode a harbour office, it must be done using a **Building** feature, with the attribute **function** taking at least one of the values:

- 2 - harbour-master's office
- 3 - custom office
- 4 - health office
- 11 - pilot office

6.2.3 Transit sheds and warehouses (see S-4 – B-328.1)

If it is required to encode a transit shed or warehouse, it must be done using a **Building** feature, with attributes **function** = 15 (transit shed/warehouse), and if it is required, **feature name (name)** = name or number of the shed.

Distinction: Built-up area; coastguard station; landmark; rescue station; silo; tank.

Feature/Information associations							
Type	Association Name	Association Ends					
		Class	Role	Mult	Class	Role	Mult
Comp	Structure/Equipment	Building	Supported by	0,1	Daymark, Fog Signal, Light Air Obstruction, Light All Around, Light Fog Detector, Light Sectored, Physical AIS Aid to Navigation, Radar	Supports	1,*

					Transponder Beacon, Retroreflector, Signal Station Traffic, Signal Station Warning		
Aggr	Range System Aggregation	Building	Consists of	1,*	Range System	Component of	0,1

6.3 Airport/airfield

IHO Definition: **AIRPORT/AIRFIELD.** A defined area on land (including any buildings, installations and equipment) intended to be used either wholly or in part for the arrival, departure and surface movement of aircraft. (Adapted from Defence Geospatial Information Working Group; Feature Data Dictionary Register, 2010).

S-101 Geo Feature: Airport/airfield (AIRARE)

Primitives: Point, Surface

<i>Real World</i>		<i>Paper Chart Symbol</i>		<i>ECDIS Symbol</i>	
S-101 Attribute	S-57 Acronym	Allowable Encoding Value	Type	Multiplicity	
Category of airport/airfield	(CATAIR)	1 : military aeroplane airport 2 : civil aeroplane airport 3 : military heliport 4 : civil heliport 5 : glider airfield 6 : small planes airfield 8 : emergency airfield 9 : search and rescue airfield	EN	0,*	
Condition	(CONDTN)	1 : under construction 2 : ruined 3 : under reclamation 5 : planned construction	EN	0,1	
Feature name			C	0,*	
Display name			(S) BO	0,1	
Language		ISO 639-3	(S) TE	0,1	
Name	(OBJNAM) (NOBJNM)		(S) TE	1,1	
Reported date	(SORDAT)	ISO 8601: 2004	TD	0,1	
Status	(STATUS)	1 : permanent 2 : occasional 4 : not in use 5 : periodic/intermittent 6 : reserved 7 : temporary 8 : private 12 : illuminated 14 : public	EN	0,*	
Scale minimum	(SCAMIN)	See clause X.X	IN	0,1	

INT 1 Reference: D 17

6.3.1 Airfields (see S-4 – B-366)

Airfields (or airports) within a few miles of the coast must be charted on larger and medium maximum display scale ENC data; they are significant to coastal navigation because of the many visual and audible features associated with them and the related air traffic.

For ENC data at larger maximum display scales, an airport should be encoded using a combination of the following features: **Airport/Airfield** (surface), **Runway** (surface or curve), **Building** (surface or point) and **Landmark** (surface or point). At least one **Airport/Airfield** or **Runway** must be in this set of features.

For ENC data at smaller maximum display scales, an airport should be encoded as an **Airport/Airfield** of type point.

Remarks:

- If individual buildings are visually conspicuous, they must be encoded as separate features.
- If it is required to encode the control tower, it must be done using a **Landmark** feature, with attributes **function** = 39 (control) and **category of landmark** = 17 (tower). If it is required to encode other buildings, this must be done using the feature **Building**.
- If it is required to encode a seaplane landing area, it must be done using the feature **Seaplane Landing Area** (see clause X.X).
- For navigational aids associated with air navigation, and air obstruction lights, see clauses related to navigational aids.

Distinction: Runway; seaplane landing area.

6.4 Runway

IHO Definition: **RUNWAY.** A defined area, on a land aerodrome, prepared for the landing and take-off run of aircraft, including helicopters. (Adapted from IHO Dictionary – S-32).

S-101 Geo Feature: Runway (RUNWAY)

Primitives: Point, Curve, Surface

Real World

Paper Chart Symbol

ECDIS Symbol

S-101 Attribute	S-57 Acronym	Allowable Encoding Value	Type	Multiplicity
Category of runway	(CATRUN)	1 : aeroplane runway 2 : helicopter landing pad	EN	0,*
Condition	(COND TN)	1 : under construction 2 : ruined 3 : under reclamation 5 : planned construction	EN	0,1
Feature name			C	0,*
Display name			(S) BO	0,1
Language		ISO 639-3	(S) TE	0,1
Name	(OBJNAM) (NOBJNM)		(S) TE	1,1
Nature of construction	(NATCON)	1 : masonry 2 : concreted 4 : hard surfaced 5 : unsurfaced 6 : wooden 7 : metal	EN	0,*
Periodic date range			C	0,*
Date end	(PEREND)	ISO 8601: 2004	(S) TD	1,1
Date start	(PERSTA)	ISO 8601: 2004	(S) TD	1,1
Reported date	(SORDAT)	ISO 8601: 2004	TD	0,1
Status	(STATUS)	1 : permanent 2 : occasional 4 : not in use 5 : periodic/intermittent 6 : reserved 7 : temporary 8 : private 12 : illuminated 14 : public	EN	0,*
Scale minimum	(SCAMIN)	See clause X.X	IN	0,1

INT 1 Reference: D 17

6.4.1 Airfields (see S-4 – B-366)

Airfields (or airports) within a few miles of the coast must be encoded on large and medium maximum display scale ENC data; they are significant to coastal navigation because of the many visual and audible features associated with them and the related air traffic.

For larger maximum display scale ENC data, an airport should be encoded using a combination of the

following features: **Airport/Airfield** (surface), **Runway** (surface or curve), **Building** (surface or point) and **Landmark** (surface or point). At least one **Airport/Airfield** or **Runway** must be in this set of features.

Remarks:

- Two or more crossing runways may be encoded as one surface.
- If it is required to encode a seaplane landing area, it must be done using the feature **Seaplane Landing Area** (see clause X.X).
- For navigational aids associated with air navigation, and air obstruction lights, see clauses related to navigational aids.

Distinction: Airport/airfield; seaplane landing area.

6.5 Bridge

IHO Definition: BRIDGE. A structure erected over a depression or an obstacle such as a body of water, railroad, etc., to provide a roadway for vehicles or pedestrians. (IHO Dictionary – S-32).				
S-101 Geo Feature: Bridge (BRIDGE)				
Primitives: Curve, Surface, None				
<i>Real World</i>		<i>Paper Chart Symbol</i>		<i>ECDIS Symbol</i>
S-101 Attribute	S-57 Acronym	Allowable Encoding Value	Type	Multiplicity
Category of bridge	(CATBRG)	1 : fixed bridge 2 : opening bridge 3 : swing bridge 4 : lifting bridge 5 : bascule bridge 6 : pontoon bridge 7 : drawbridge 8 : transporter bridge 9 : footbridge 10 : viaduct 11 : aqueduct 12 : suspension bridge	EN	0,1
Colour	(COLOUR)	1 : white 2 : black 3 : red 4 : green 5 : blue 6 : yellow 7 : grey 8 : brown 9 : amber 10 : violet 11 : orange 12 : magenta 13 : pink	EN	0,* (ordered)
Colour pattern	(COLPAT)	1 : horizontal stripes 2 : vertical stripes 3 : diagonal stripes 4 : squared 5 : stripes (direction unknown) 6 : border stripe	EN	0,1
Condition	(CONDTN)	1 : under construction 2 : ruined 5 : planned construction	EN	0,1
Feature name			C	0,*
Display name			(S) BO	0,1
Language		ISO 639-3	(S) TE	0,1
Name	(OBJNAM) (NOBJNM)		(S) TE	1,1
Fixed date range			C	0,1
Date end	(DATEND)	ISO 8601: 2004	(S) TD	0,1

Date start	(DATSTA)	ISO 8601: 2004	(S) TD	0,1
Height	(HEIGHT)		RE	0,1
Nature of construction	(NATCON)	1 : masonry 2 : concreted 6 : wooden 7 : metal 11 : latticed	EN	0,*
Radar conspicuous	(CONRAD)		BO	0,1
Reported date	(SORDAT)	ISO 8601: 2004	TD	0,1
Status	(STATUS)	1 : permanent 2 : occasional 4 : not in use 5 : periodic/intermittent 7 : temporary 12 : illuminated	EN	0,*
Visually conspicuous	(CONVIS)	1 : visually conspicuous 2 : not visually conspicuous 3 : prominent	EN	0,1
Scale minimum	(SCAMIN)	See clause X.X	IN	0,1

INT 1 Reference: D 20-24

6.5.1 Bridges (see S4 – B-381)

If it is required to encode a bridge, it must be done using the feature **Bridge**. Bridges may be encoded over water that is navigable or non-navigable at the maximum display scale of the ENC data. Where the bridge is encoded over navigable water, the components of the bridge must be associated with the feature **Bridge** (see clause X.X) using the associations **Bridge Aggregation** (see clause X.X) and **Bridge Association** (see clause X.X) (that is, the **Bridge** feature has no geometry, but inherits the geometry of the component features). Where the bridge is encoded over non-navigable water, then it must be encoded, where required, using a **Bridge** feature having no component features (that is, the **Bridge** feature has geometry of type curve or surface).

The value of the vertical clearance between (high) water level and any fixed overhead obstruction must always be given, where known, on the largest maximum display scale ENC data intended for navigation under the obstruction, and for detailed passage planning. The datum above which clearances are given must be a high water level, preferably Highest Astronomical Tide (HAT), where the tide is appreciable. The value for the vertical clearance must be encoded using the features **Span Fixed** or **Span Opening** (see clauses X.X and X.X), with the clearance(s) populated using the complex attributes **vertical clearance fixed**, **vertical clearance closed** and/or **vertical clearance open**, and sub-attributes populated relevant to the span. In areas where the tidal range is not appreciable the datum above which clearances are given should be Mean Sea Level (MSL).

Remarks:

- Water under a bridge must be encoded using the features **Depth Area**, **Dredged Area** or **Unsurveyed Area** (and appropriate **Depth Contour** and **Sounding** features) if the waterway is navigable at the maximum display scale for the ENC data, or using the features **Land Area** if the waterway is not navigable at the maximum display scale for the ENC data.
- When there is a fixed vertical clearance, closed vertical clearance, or open vertical clearance given for a bridge, it should be applied only to the portion of the bridge to which the clearance refers, using the features **Span Fixed** or **Span Opening** (see clauses X.X and X.X). All encoded bridge spans must be associated with the **Bridge** feature using the association **Bridge Aggregation** (see clause X.X). See examples in the Figures below. If there are no vertical clearances given for a bridge and it is over water that is navigable at the maximum display scale of the ENC data, a single **Span Fixed** or **Span Opening** feature must be encoded covering the area of the bridge, having mandatory vertical clearance attributes populated with an empty (null) value.
- The attribute **height** is used, where required, to encode the height of the highest point on the bridge structure (see clause X.X).
- If it is required to encode a sliding bridge, it must be done using a **Bridge** feature, with attribute **category of bridge** = 7 (drawbridge).

- If it is required to encode a distance mark that is included on or associated with a bridge, this must be done using the feature **Distance Mark** (see clause X.X).
- In navigable water, bridge supports must be encoded, where possible, using a **Pylon/Bridge Support** feature (see clause X.X), with attribute **category of pylon** = 4 (bridge/pylon tower) or 5 (bridge pier).
- It is not mandatory to encode roads or railways on bridges.

6.5.2 Examples of Encoding Common Bridge Types

OPENING BRIDGE

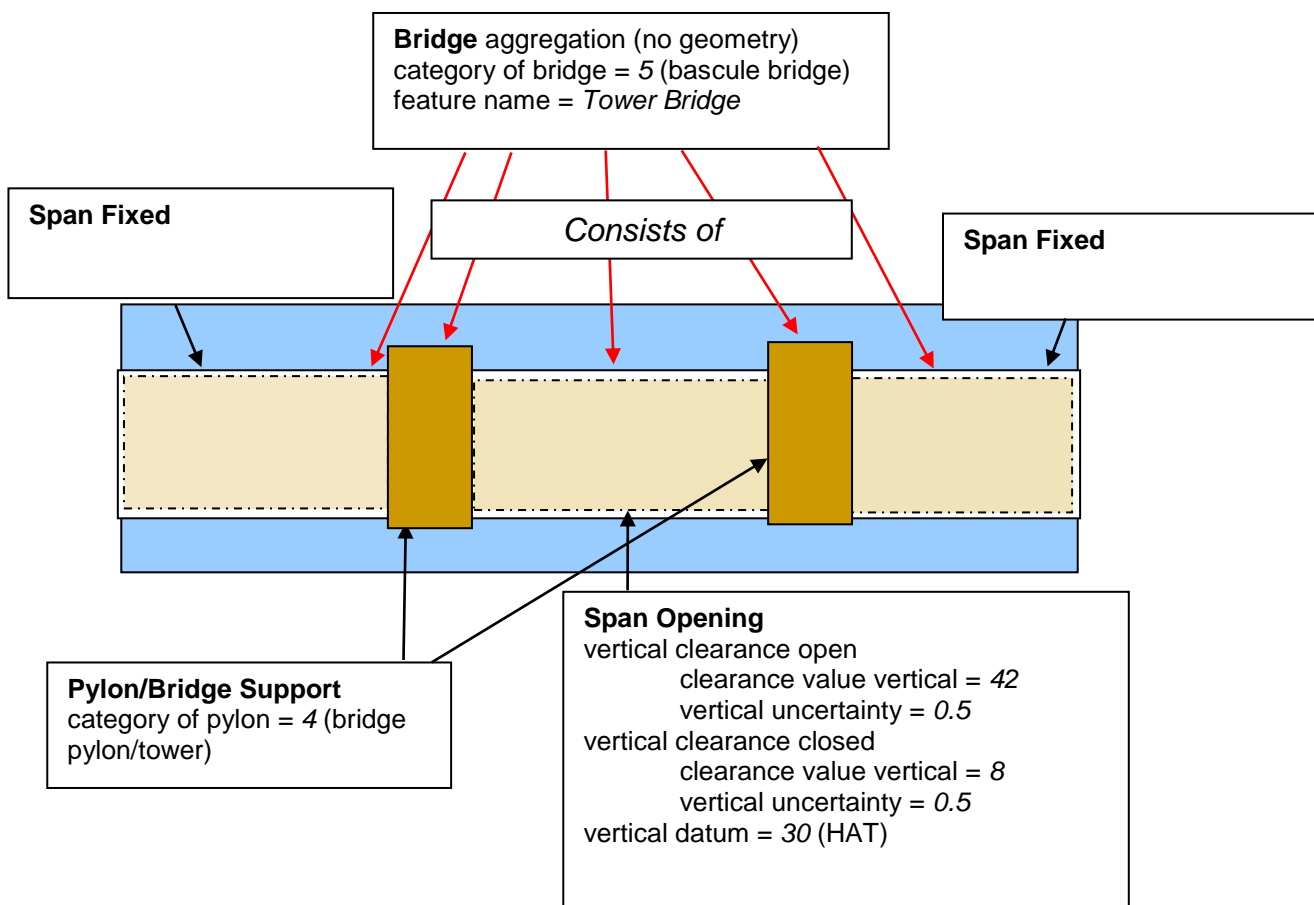

Distinction: Pipeline, overhead; pylon/bridge support; span fixed; span opening.

Feature/Information associations

Type	Association Name	Association Ends					
		Class	Role	Mult	Class	Role	Mult
Comp	Structure/Equipment	Bridge	Supported by	0,1	Daymark, Fog Signal, Light Air Obstruction, Light All Around, Light Fog Detector, Light Sector, Physical AIS Aid to Navigation, Radar Transponder Beacon, Retroreflector, Signal Station Traffic, Signal Station Warning	Supports	1,*
Aggr	Bridge Aggregation	Bridge	Component of	0,1	Span Fixed, Span Opening, Pylon/Bridge	Consists of	1,*

					Support		
--	--	--	--	--	----------------	--	--

6.6 Span fixed

IHO Definition: **SPAN FIXED.** A fixed component of the deck of a bridge spanning successive bridge piers. (Adapted from Defence Geospatial Information Working Group; Feature Data Dictionary Register, 2013).

S-101 Geo Feature: Span fixed

Primitives: Curve, Surface

Real World

Paper Chart Symbol

ECDIS Symbol

S-101 Attribute	S-57 Acronym	Allowable Encoding Value	Type	Multiplicity
Fixed date range			C	0,1
Date end	(DATEND)	ISO 8601: 2004	(S) TD	0,1
Date start	(DATSTA)	ISO 8601: 2004	(S) TD	0,1
Horizontal clearance fixed			C	0,1
Horizontal clearance value	(HORCLR)		(S) RE	1,1
Horizontal distance uncertainty	(HORACC)		(S) RE	0,1
Vertical clearance fixed			C	1,1
Vertical clearance value	(VERCLR)		(S) RE	1,1
Vertical uncertainty	(VERACC)		(S) C	0,1
Uncertainty fixed			(S) RE	1,1
Uncertainty variable			(S) RE	0,1
Vertical datum	(VERDAT)	3 : Mean sea level 16 : Mean high water 17 : Mean high water springs 18 : High water 19 : Approximate mean sea level 20 : High water springs 21 : Mean higher high water 24 : Local datum 25 : International great lakes datum 1985 26 : Mean water level 28 : Higher high water large tide 29 : Nearly highest high water 30 : Highest astronomical tide (HAT)	EN	0,1

INT 1 Reference:

6.6.1 Span fixed

If it is required to encode the clearance characteristics (vertical or horizontal) for any fixed part of a bridge between piers or supports, it must be done using the feature **Span Fixed**, which must be associated with the feature **Bridge** (see clause X.X) using the association **Bridge Aggregation** (see clause X.X). See clause X.X for examples of **Span Fixed** features aggregated to **Bridge**.

The value of the vertical clearance between (high) water level and any fixed overhead obstruction must always

be given, where known, on the largest optimum display scale ENC data intended for navigation under the overhead obstruction, and for detailed passage planning. The datum above which clearances are given must be a high water level, preferably Highest Astronomical Tide (HAT), where the tide is appreciable. Clearances must be populated using the complex attribute **vertical clearance fixed** and sub-attributes populated relevant to the feature, rounded down to the nearest whole metre (unless under 10m, when metres and decimetres may be quoted). In areas where the tidal range is not appreciable the datum above which clearances are given should be Mean Sea Level (MSL).

Remarks:

- **Span Fixed** features should only be encoded if the span is entirely or partly over navigable water at the maximum display scale for the ENC data.
- Where the maximum display scale of the ENC data is such that individual spans on a fixed bridge over navigable water cannot be indicated, the entire bridge should be covered by a single **Span Fixed** feature, having attributes populated according to the most navigationally important span.

Distinction: Bridge; conveyor; overhead cable; overhead pipeline; span opening.

Feature/Information associations							
Type	Association Name	Association Ends					
		Class	Role	Mult	Class	Role	Mult
Comp	Structure/Equipment	Span Fixed	Supported by	0,1	Daymark, Fog Signal, Light Air Obstruction, Light All Around, Light Fog Detector, Light Sectored, Physical AIS Aid to Navigation, Radar Transponder Beacon, Retroreflector, Signal Station Traffic, Signal Station Warning	Supports	1,*
Aggr	Bridge Aggregation	Span Fixed	Consists of	1,*	Bridge	Component of	0,1

6.7 Span opening

IHO Definition: SPAN OPENING. An opening component of the deck of a bridge spanning successive bridge piers. (Adapted from Defence Geospatial Information Working Group; Feature Data Dictionary Register, 2013).

S-101 Geo Feature: Span opening

Primitives: Curve, Surface

Real World

Paper Chart Symbol

ECDIS Symbol

S-101 Attribute	S-57 Acronym	Allowable Encoding Value	Type	Multiplicity
Fixed date range			C	0,1
Date end	(DATEND)	ISO 8601: 2004	(S) TD	0,1
Date start	(DATSTA)	ISO 8601: 2004	(S) TD	0,1
Horizontal clearance fixed			C	0,1
Horizontal clearance value	(HORCLR)		(S) RE	1,1
Horizontal distance uncertainty	(HORACC)		(S) RE	0,1
Vertical clearance closed			C	1,1
Vertical clearance value	(VERCCL)		(S) RE	1,1
Vertical uncertainty	(VERACC)		(S) C	0,1
Uncertainty fixed			(S) RE	1,1
Uncertainty variable			(S) RE	0,1
Vertical clearance open			C	1,1
Vertical clearance value	(VERCOP)		(S) RE	1,1
Vertical uncertainty	(VERACC)		(S) C	0,1
Uncertainty fixed			(S) RE	1,1
Uncertainty variable			(S) RE	0,1
Vertical datum	(VERDAT)	3 : Mean sea level 16 : Mean high water 17 : Mean high water springs 18 : High water 19 : Approximate mean sea level 20 : High water springs 21 : Mean higher high water 24 : Local datum 25 : International great lakes datum 1985 26 : Mean water level 28 : Higher high water large tide 29 : Nearly highest high water 30 : Highest astronomical tide (HAT)	EN	0,1

INT 1 Reference:**6.7.1 Span opening**

If it is required to encode the clearance characteristics (vertical or horizontal) for an opening part of a bridge between piers or supports, it must be done using the feature **Span Opening**, which must be associated with the feature **Bridge** (see clause X.X) using the association **Bridge Aggregation** (see clause X.X). See clause X.X for examples of **Span Opening** features used in conjunction with **Bridge** features.

The value of the vertical clearance between (high) water level and any opening overhead obstruction must always be given, where known, on the largest optimum display scale ENC data intended for navigation under the overhead obstruction, and for detailed passage planning. The datum above which clearances are given must be a high water level, preferably Highest Astronomical Tide (HAT), where the tide is appreciable. Clearances must be populated using the complex attributes **vertical clearance closed** and **vertical clearance open** for the span and sub-attributes populated relevant to the feature, rounded down to the nearest whole metre (unless under 10m, when metres and decimetres may be quoted). In areas where the tidal range is not appreciable the datum above which clearances are given should be Mean Sea Level (MSL).

Remarks:

- **Span Opening** features should only be encoded if the span is entirely or partly over navigable water at the maximum display scale for the ENC data.
- Where the maximum display scale of the ENC data is such that individual spans over navigable water cannot be indicated, the entire bridge should be covered by a single **Span Opening** feature, having attributes populated according to the opening span.
- The complex attributes **vertical clearance closed** and **vertical clearance open** must be encoded for both the opening (vertical open) and closed (vertical closed) clearance values. Where the open vertical clearance is unlimited, **vertical clearance open** must be populated with an empty (null) value.
- Where it is required to encode time schedule information relating to the opening and closing times for the span, including any scheduled closure times or amended schedules for festivals or national holidays, this should be done using an associated instance of the information classes **Service Hours** (see clause X.X) and/or **Non-Standard Working Day** (see clause X.X).

Distinction: Bridge; conveyor; overhead cable; overhead pipeline; span fixed.

Feature/Information associations

Type	Association Name	Association Ends					
		Class	Role	Mult	Class	Role	Mult
Comp	Structure/Equipment	Span Opening	Supported by	0,1	Daymark, Fog Signal, Light Air Obstruction, Light All Around, Light Fog Detector, Light Sector, Physical AIS Aid to Navigation, Radar Transponder Beacon, Retroreflector, Signal Station Traffic, Signal Station Warning	Supports	1,*
Aggr	Bridge Aggregation	Span Opening	Consists of	1,*	Bridge	Component of	0,1
Asso	Additional Information	Span Opening	Provides information	1,*	Non-Standard Working Day, Service Hours	Information provided for	0,1

6.8 Conveyor

IHO Definition: CONVEYOR. A mechanical device for conveying bulk material or people using an endless moving belt or series of rollers. (Adapted from Defence Geospatial Information Working Group; Feature Data Dictionary Register, 2010).

S-101 Geo Feature: Conveyor (CONVYR)

Primitives: Curve, Surface

Real World

Paper Chart Symbol

ECDIS Symbol

S-101 Attribute	S-57 Acronym	Allowable Encoding Value	Type	Multiplicity
Category of conveyor	(CATCON)	1 : aerial cableway (telepheric) 2 : conveyor 3 : flume 4 : lift/elevator	EN	0,1
Colour	(COLOUR)	1 : white 2 : black 3 : red 4 : green 5 : blue 6 : yellow 7 : grey 8 : brown 9 : amber 10 : violet 11 : orange 12 : magenta 13 : pink	EN	0,* (ordered)
Colour pattern	(COLPAT)	1 : horizontal stripes 2 : vertical stripes 3 : diagonal stripes 4 : squared 5 : stripes (direction unknown) 6 : border stripe	EN	0,1
Condition	(CONDTN)	1 : under construction 2 : ruined 5 : planned construction	EN	0,1
Feature name			C	0,*
Display name			(S) BO	0,1
Language		ISO 639-3	(S) TE	0,1
Name	(OBJNAM) (NOBJNM)		(S) TE	1,1
Fixed date range			C	0,1
Date end	(DATEND)	ISO 8601: 2004	(S) TD	0,1
Date start	(DATSTA)	ISO 8601: 2004	(S) TD	0,1
Height	(HEIGHT)		RE	0,1
Lifting capacity	(LIFCAP)		RE	0,1

Multiplicity of features			C	0,1
Multiplicity known			(S) BO	1,1
Number of features			(S) IN	0,1
Product	(PRODCT)	4 : stone 5 : coal 6 : ore 10 : bauxite 11 : coke 12 : iron ingots 13 : salt 14 : sand 15 : timber 16 : sawdust/wood chips 17 : scrap metal 22 : grain 25 : clay	EN	0,1
Radar conspicuous	(CONRAD)		BO	0,1
Reported date	(SORDAT)	ISO 8601: 2004	TD	0,1
Status	(STATUS)	4 : not in use 12 : illuminated	EN	0,*
Vertical clearance fixed			C	0,1
Vertical clearance value	(VERCLR)		(S) RE	1,1
Vertical uncertainty	(VERACC)		(S) C	0,1
Uncertainty fixed			(S) RE	1,1
Uncertainty variable			(S) RE	0.1
Vertical length	(VERLEN)		RE	0,1
Visually conspicuous	(CONVIS)	1 : visually conspicuous 2 : not visually conspicuous 3 : prominent	EN	0,1
Vertical datum	(VERDAT)	3 : Mean sea level 16 : Mean high water 17 : Mean high water springs 18 : High water 19 : Approximate mean sea level 20 : High water springs 21 : Mean higher high water 24 : Local datum 25 : International great lakes datum 1985 26 : Mean water level 28 : Higher high water large tide 29 : Nearly highest high water 30 : Highest astronomical tide (HAT)	EN	0,1
Scale minimum	(SCAMIN)	See clause X.X	IN	0,1

INT 1 Reference: D 25

6.8.1 Conveyors (see S-4 – B-382.3)

If it is required to encode a conveyor, it must be done using the feature **Conveyor**.

The value of the vertical clearance between (high) water level and any fixed overhead obstruction must always be given, where known, on the largest maximum display scale ENC data intended for navigation under the

obstruction, and for detailed passage planning. The datum above which clearances are given must be a high water level, preferably Highest Astronomical Tide (HAT), where the tide is appreciable. The value for the vertical clearance must be encoded using the complex attribute **vertical clearance fixed**, and sub-attributes populated relevant to the feature, rounded down to the nearest whole metre (unless under 10m, when metres and decimetres may be quoted). In areas where the tidal range is not appreciable the datum above which clearances are given should be Mean Sea Level (MSL).

Remarks:

- If it is required to encode an overhead cable car, it must be done using a **Conveyor** feature, with attribute **category of conveyor** = 1 (aerial cableway (telepheric)).
- In navigable water, conveyor supports must be encoded, where possible, using a **Pylon/Bridge Support** feature (see clause X.X), with attribute **category of pylon** = 3 (aerial cableway/sky pylon).

Distinction: Cable, overhead; crane; pylon/bridge support.

Feature/Information associations							
Type	Association Name	Association Ends					
		Class	Role	Mult	Class	Role	Mult
Comp	Structure/Equipment	Conveyor	Supported by	0,1	Daymark, Fog Signal, Light Air Obstruction, Light All Around, Light Fog Detector, Light Sectored, Physical AIS Aid to Navigation, Radar Transponder Beacon, Retroreflector, Signal Station Traffic, Signal Station Warning	Supports	1,*

6.9 Overhead cables

IHO Definition: CABLE, OVERHEAD. A single continuous rope-like bundle consisting of multiple strands of fiber, plastic, metal, and/or glass, which is supported by structures such as poles or pylons and passing over or nearby navigable waters. (Adapted from Defence Geospatial Information Working Group; Feature Data Dictionary Register, 2012).

S-101 Geo Feature: Cable overhead (CBLOHD)

Primitives: Curve

<i>Real World</i>	<i>Paper Chart Symbol</i>	<i>ECDIS Symbol</i>		
S-101 Attribute	S-57 Acronym	Allowable Encoding Value	Type	Multiplicity
Category of cable	(CATCBL)	1 : power line 3 : transmission line 4 : telephone 5 : telegraph	EN	0,1
Condition	(CONDTN)	1 : under construction 5 : planned construction	EN	0,1
Fixed date range			C	0,1
Date end	(DATEND)	ISO 8601: 2004	(S) TD	0,1
Date start	(DATSTA)	ISO 8601: 2004	(S) TD	0,1
Ice factor	(ICEFAC)		RE	0,1
Feature name			C	0,*
Display name			(S) BO	0,1
Language		ISO 639-3	(S) TE	0,1
Name	(<i>OBJNAM</i>) (<i>NOBJNM</i>)		(S) TE	1,1
Multiplicity of features			C	0,1
Multiplicity known			(S) BO	1,1
Number of features			(S) IN	0,1
Radar conspicuous	(CONRAD)		BO	0,1
Reported date	(<i>SORDAT</i>)	ISO 8601: 2004	TD	0,1
Status	(STATUS)	1 : permanent 4 : not in use 5 : periodic/intermittent 7 : temporary 12 : illuminated 28 : buoyed	EN	0,*
Vertical clearance fixed			C	0,1
Vertical clearance value	(<i>VERCLR</i>)		(S) RE	1,1
Vertical uncertainty	(<i>VERACC</i>)		(S) C	0,1
Uncertainty fixed			(S) RE	1,1
Uncertainty variable			(S) RE	0,1
Vertical clearance safe			C	0,1

Clearance value vertical	(VERCSA)		(S) RE	1,1
Vertical uncertainty	(VERACC)		(S) C	0,1
Uncertainty fixed			(S) RE	1,1
Uncertainty variable			(S) RE	0.1
Vertical datum	(VERDAT)	3 : Mean sea level 16 : Mean high water 17 : Mean high water springs 18 : High water 19 : Approximate mean sea level 20 : High water springs 21 : Mean higher high water 24 : Local datum 25 : International great lakes datum 1985 26 : Mean water level 28 : Higher high water large tide 29 : Nearly highest high water 30 : Highest astronomical tide (HAT)	EN	0,1
Visually conspicuous	(CONVIS)	1 : visually conspicuous 2 : not visually conspicuous 3 : prominent	EN	0,1
Scale minimum	(SCAMIN)	See clause X.X	IN	0,1

INT 1 Reference: D 26, 27

6.9.1 Overhead cables (see S-4 – B-382)

If it is required to encode an overhead cable, it must be done using the feature **Cable Overhead**.

The value of the vertical clearance between (high) water level and any fixed overhead obstruction must always be given, where known, on the largest maximum display scale ENC data intended for navigation under the obstruction, and for detailed passage planning. The datum above which clearances are given must be a high water level, preferably Highest Astronomical Tide (HAT), where the tide is appreciable. The value for the vertical clearance must be encoded using the complex attributes **vertical clearance fixed** and sub-attributes populated relevant to the feature, rounded down to the nearest whole metre (unless under 10m, when metres and decimetres may be quoted). In areas where the tidal range is not appreciable the datum above which clearances are given should be Mean Sea Level (MSL).

For power cables or transmission lines carrying very high voltages, an additional vertical clearance of from 2 to 5 metres may be needed to avoid an electrical discharge. When known, the authorised safe clearance (known as the safe vertical clearance), which is the physical clearance minus a safety margin, must be populated using the complex attribute **vertical clearance safe** having the sub-attribute **clearance value vertical** populated with the safe clearance value.

Remarks:

- If it is required to encode telepheric cables, this must be done using **Conveyor** features (see clause X.X), with attribute CATCON = 1 (aerial cableway (telepheric)).
- Where a cable has radar reflectors at known positions, they must be encoded as separate **Radar Reflector** features (see clause X.X). If the whole cable is radar conspicuous, the maximum display scale for the ENC data is too small to show individual reflectors, or the positions of the radar reflectors are not known, the **Cable Overhead** should be encoded with attribute **radar conspicuous**.
- In navigable water, overhead cable supports must be encoded, where possible, using a **Pylon/Bridge Support** feature (see clause X.X), with attribute **category of pylon** = 1 or 2.

Distinction: Cable area; cable, submarine; conveyor; pylon/bridge support.

Feature/Information associations							
Type	Association Name	Association Ends					
		Class	Role	Mult	Class	Role	Mult
Comp	Structure/Equipment	Cable Overhead	Supported by	0,1	Radar Reflector	Supports	1,*

6.10 Pipeline, overhead

IHO Definition: OVERHEAD PIPELINE. A string of interconnected pipes, supported by pylons and passing over or nearby navigable waters, used for the transport of matter, nowadays mainly oil or gas. (Adapted from IHO Dictionary – S-32 and S-57 Edition 3.1, Appendix A – Chapter 1, Page 1.119, November 2000).

S-101 Geo Feature: Pipeline overhead (PIPOHD)

Primitives: Curve

Real World

Paper Chart Symbol

ECDIS Symbol

S-101 Attribute	S-57 Acronym	Allowable Encoding Value	Type	Multiplicity
Category of pipeline/pipe	(CATPIP)	2 : outfall pipe 3 : intake pipe 4 : sewer 6 : supply pipe	EN	0,1
Condition	(CONDTN)	1 : under construction 5 : planned construction	EN	0,1
Feature name			C	0,*
Display name			(S) BO	0,1
Language		ISO 639-3	(S) TE	0,1
Name	(<i>OBJNAM</i>) (<i>NOBJNM</i>)		(S) TE	1,1
Fixed date range			C	0,1
Date end	(DATEND)	ISO 8601: 2004	(S) TD	0,1
Date start	(DATSTA)	ISO 8601: 2004	(S) TD	0,1
Multiplicity of features			C	0,1
Multiplicity known			(S) BO	1,1
Number of features			(S) IN	0,1
Product	(PRODCT)	1 : oil 2 : gas 3 : water 7 : chemicals 8 : drinking water 9 : milk 18 : liquefied natural gas (LNG) 19 : liquefied petroleum gas (LPG) 20 : wine 22 : grain	EN	0,*
Radar conspicuous	(CONRAD)		BO	0,1
Reported date	(<i>SORDAT</i>)	ISO 8601: 2004	TD	0,1
Status	(STATUS)	1 : permanent 4 : not in use 7 : temporary 12 : illuminated	EN	0,*
Vertical clearance fixed			C	0,1

Vertical clearance value	(VERCLR)		(S) RE	1,1
Vertical uncertainty	(VERACC)		(S) C	0,1
Uncertainty fixed			(S) RE	1,1
Uncertainty variable			(S) RE	0.1
Vertical datum	(VERDAT)	3 : Mean sea level 16 : Mean high water 17 : Mean high water springs 18 : High water 19 : Approximate mean sea level 20 : High water springs 21 : Mean higher high water 24 : Local datum 25 : International great lakes datum 1985 26 : Mean water level 28 : Higher high water large tide 29 : Nearly highest high water 30 : Highest astronomical tide (HAT)	EN	0,1
Visually conspicuous	(CONVIS)	1 : visually conspicuous 2 : not visually conspicuous 3 : prominent	EN	0,1
Scale minimum	(SCAMIN)	See clause X.X	IN	0,1

INT 1 Reference: D 28

6.10.1 Overhead pipelines (see S-4 – B-383)

If it is required to encode an overhead pipeline passing over or nearby navigable waters, it must be done using the feature **Pipeline Overhead**.

The value of the vertical clearance between (high) water level and any fixed overhead obstruction must always be given, where known, on the largest maximum display scale ENC data intended for navigation under the obstruction, and for detailed passage planning. The datum above which clearances are given must be a high water level, preferably Highest Astronomical Tide (HAT), where the tide is appreciable. The value for the vertical clearance must be encoded using the complex attribute **vertical clearance fixed**, and sub-attributes populated relevant to the feature, rounded down to the nearest whole metre (unless under 10m, when metres and decimetres may be quoted). In areas where the tidal range is not appreciable the datum above which clearances are given should be Mean Sea Level (MSL).

Remarks:

- Where an overhead pipeline is disused, it should be encoded with the attribute **status = 4** (not in use), and the attributes **category of pipe** and **product** must not be encoded.
- Where a pipeline has radar reflectors at known positions, they must be encoded as separate **Radar Reflector** features (see clause X.X). If the whole pipeline is radar conspicuous, the maximum display scale for the ENC data is too small to show individual reflectors, or the positions of the radar reflectors are not known, the **Pipeline Overhead** should be encoded with attribute **radar conspicuous**.

Distinction: Pipeline, submarine/on land, submarine pipeline area.

Feature/Information associations							
Type	Association Name	Association Ends					
		Class	Role	Mult	Class	Role	Mult
Comp	Structure/Equipment	Pipeline Overhead	Supported by	0,1	Daymark, Fog Signal, Light Air Obstruction,	Supports	1,*

					Light All Around, Light Fog Detector, Light Sected, Physical AIS Aid to Navigation, Radar Transponder Beacon, Retroreflector, Signal Station Traffic, Signal Station Warning		
--	--	--	--	--	---	--	--

6.11 Pylon/bridge support

IHO Definition: **PYLON/BRIDGE SUPPORT.** A vertical construction consisting, for example, of a steel framework or pre-stressed concrete to carry cables, a bridge, etc. (S-57 Edition 3.1, Appendix A – Chapter 1, Page 1.125, November 2000).

S-101 Geo Feature: Pylon/bridge support (PYLONS)

Primitives: Point, Surface

Real World

Paper Chart Symbol

ECDIS Symbol

S-101 Attribute	S-57 Acronym	Allowable Encoding Value	Type	Multiplicity
Category of pylon	(CATPYL)	1 : power transmission pylon/pole 2 : telephone/telegraph pylon/pole 3 : aerial cableway/sky pylon 4 : bridge pylon/tower 5 : bridge pier	EN	1,1
Colour	(COLOUR)	1 : white 2 : black 3 : red 4 : green 5 : blue 6 : yellow 7 : grey 8 : brown 9 : amber 10 : violet 11 : orange 12 : magenta 13 : pink	EN	0,* (ordered)
Colour pattern	(COLPAT)	1 : horizontal stripes 2 : vertical stripes 3 : diagonal stripes 4 : squared 5 : stripes (direction unknown) 6 : border stripe	EN	0,1
Condition	(CONDTN)	1 : under construction 2 : ruined 5 : planned construction	EN	0,1
Feature name			C	0,*
Display name			(S) BO	0,1
Language		ISO 639-3	(S) TE	0,1
Name	(OBJNAM) (NOBJNM)		(S) TE	1,1
Fixed date range			C	0,1
Date end	(DATEND)	ISO 8601: 2004	(S) TD	0,1
Date start	(DATSTA)	ISO 8601: 2004	(S) TD	0,1
Height	(HEIGHT)		RE	0,1

Multiplicity of features			C	0,1
Multiplicity known			(S) BO	1,1
Number of features			(S) IN	0,1
Nature of construction	(NATCON)	1 : masonry 2 : concreted 6 : wooden 7 : metal 11 : latticed	EN	0,*
Radar conspicuous	(CONRAD)		BO	0,1
Reported date	(SORDAT)	ISO 8601: 2004	TD	0,1
Status	(STATUS)	4 : not in use 12 : illuminated	EN	0,*
Vertical length	(VERLEN)		RE	0,1
Visually conspicuous	(CONVIS)	1 : visually conspicuous 2 : not visually conspicuous 3 : prominent	EN	0,1
Water level effect	(WATLEV)	1 : partly submerged at high water 2 : always dry 3 : always under water / submerged 4 : covers and uncovers 5 : awash 6 : subject to inundation or flooding	EN	0,1
Scale minimum	(SCAMIN)	See clause X.X	IN	0,1

INT 1 Reference: D 26

6.11.1 Pylons and bridge supports (see S-4 – B-381.5 and B-382.1)

The actual position of pylons supporting bridges and cables must be indicated on at least the largest maximum display scale ENC data, where they are positioned in the navigable channel or where likely to be useful for position-fixing.

Remarks:

- A **Pylon/Bridge Support** feature of type surface with attribute **water level effect** = 1, 2 or 6 must be covered by a **Land Area** feature of type surface (see clause X.X).

Distinction: Landmark.

<u>Feature/Information associations</u>							
Type	Association Name	Association Ends					
		Class	Role	Mult	Class	Role	Mult
Comp	Structure/Equipment	Pylon/Bridge Support	Supported by	0,1	Daymark, Fog Signal, Light Air Obstruction, Light All Around, Light Fog Detector, Light Sectored, Physical AIS Aid to Navigation, Radar Transponder Beacon, Retroreflector, Signal Station Traffic, Signal Station Warning	Supports	1,*

Aggr	Bridge Aggregation	Pylon/Bridge Support	Consists of	1,*	Bridge	Component of	0,1
------	--------------------	-----------------------------	-------------	-----	---------------	--------------	-----

6.12 Fence/wall

IHO Definition: **FENCE/WALL.** A man-made barrier used as an enclosure or boundary or for protection. (Adapted from Defence Geospatial Information Working Group; Feature Data Dictionary Register, 2013).

S-101 Geo Feature: Fence/wall (FNCLNE)

Primitives: Curve

Real World

Paper Chart Symbol

ECDIS Symbol

S-101 Attribute	S-57 Acronym	Allowable Encoding Value	Type	Multiplicity
Category of fence	(CATFNC)	1 : fence 3 : hedge 4 : wall	EN	0,*
Colour	(COLOUR)	1 : white 2 : black 3 : red 4 : green 5 : blue 6 : yellow 7 : grey 8 : brown 9 : amber 10 : violet 11 : orange 12 : magenta 13 : pink	EN	0,* (ordered)
Colour pattern	(COLPAT)	1 : horizontal stripes 2 : vertical stripes 3 : diagonal stripes 4 : squared 5 : stripes (direction unknown) 6 : border stripe	EN	0,1
Condition	(CONDTN)	1 : under construction 2 : ruined 5 : planned construction	EN	0,1
Elevation	(ELEVAT)		RE	0,1
Feature name			C	0,*
Display name			(S) BO	0,1
Language		ISO 639-3	(S) TE	0,1
Name	(OBJNAM) (NOBJNM)		(S) TE	1,1
Height	(HEIGHT)		RE	0,1
Nature of construction	(NATCON)	1 : masonry 2 : concreted 3 : loose boulders 6 : wooden 7 : metal 11 : latticed	EN	0,*
Radar conspicuous	(CONRAD)		BO	0,1

Reported date	(SORDAT)	ISO 8601: 2004	TD	0,1
Status	(STATUS)	1 : permanent 7 : temporary 12 : illuminated 13 : historic	EN	0,*
Vertical length	(VERLEN)		RE	0,1
Visually conspicuous	(CONVIS)	1 : visually conspicuous 2 : not visually conspicuous 3 : prominent	EN	0,1
Scale minimum	(SCAMIN)	See clause X.X	IN	0,1

INT 1 Reference:**6.12.1 Fences and walls**

If it is required to encode a fence or wall, it must be done using the feature **Fence/Wall**.

Remarks:

- No remarks.

Distinction:

6.13 Railway

IHO Definition: **RAILWAY**. A rail or set of parallel rails on which a train, tram, or rail wagon runs. (Defence Geospatial Information Working Group; Feature Data Dictionary Register, 2010).

S-101 Geo Feature: Railway (RAILWY)

Primitives: Curve

Real World

Paper Chart Symbol

ECDIS Symbol

S-101 Attribute	S-57 Acronym	Allowable Encoding Value	Type	Multiplicity
Condition	(CONDTN)	1 : under construction 2 : ruined 5 : planned construction	EN	0,1
Feature name			C	0,*
Display name			(S) BO	0,1
Language		ISO 639-3	(S) TE	0,1
Name	(OBJNAM) (NOBJNM)		(S) TE	1,1
Height	(HEIGHT)		RE	0,1
Reported date	(SORDAT)	ISO 8601: 2004	TD	0,1
Status	(STATUS)	1 : permanent 4 : not in use 6 : reserved 12 : illuminated 13 : historic 14 : public	EN	0,*
Scale minimum	(SCAMIN)	See clause X.X	IN	0,1

INT 1 Reference: D 13

6.13.1 Railways (see S-4 – B-328.4 and B-362)

In urbanized areas, depiction of railways within some miles of the coast is part of the ENCs' function in giving a general indication of the degree of land development. In largely undeveloped areas, the depiction of railways to isolated ports draws attention to such ports and may be of some maritime interest for transport purposes. Railways should be encoded on larger and medium maximum display scale ENC data.

Where railways run just inshore of the coast, or down to it, together with associated bridges, signal posts and other structure, they provide essential identification features. It should not generally be necessary to depict the smaller associated features - posts, gantries etc.

If it is required to encode a railway, it must be done using the feature **Railway**.

Remarks:

- If it is required to encode a railway station, it must be done using a **Building** feature, with attribute **function** = 8 (railway station). On the largest maximum display scale ENC data, the names of railway terminals or main stations may be populated using the attribute **feature name** for the **Building**.
- Abandoned railways (those which are mostly still intact) should be encoded, if required, as **Railway** with the attribute **status** = 4 (not in use).

Distinction: Road; shoreline construction; tunnel.

6.14 Road

IHO Definition: ROAD. A route with a specially prepared surface that is intended for use by wheeled vehicles or pedestrians. (Adapted from Defence Geospatial Information Working Group; Feature Data Dictionary Register, 2013).

S-101 Geo Feature: Road (ROADWY)

Primitives: Curve, Surface

Real World

Paper Chart Symbol

ECDIS Symbol

S-101 Attribute	S-57 Acronym	Allowable Encoding Value	Type	Multiplicity
Category of road	(CATROD)	1 : motorway 2 : major road 3 : minor road 4 : track/path 5 : major street 6 : minor street	EN	0,1
Condition	(COND TN)	1 : under construction 2 : ruined 5 : planned construction	EN	0,1
Feature name			C	0,*
Display name			(S) BO	0,1
Language		ISO 639-3	(S) TE	0,1
Name	(OBJNAM) (NOBJNM)		(S) TE	1,1
Nature of construction	(NATCON)	1 : masonry 2 : concreted 4 : hard surfaced 5 : unsurfaced	EN	0,*
Reported date	(SORDAT)	ISO 8601: 2004	TD	0,1
Status	(STATUS)	1 : permanent 4 : not in use 6 : reserved 7 : temporary 8 : private 12 : illuminated 13 : historic 14 : public	EN	0,*
Scale minimum	(SCAMIN)	See clause X.X	IN	0,1

INT 1 Reference: D 7, 10-12

6.14.1 Roads and tracks (see S-4 – B-365)

On the largest maximum display scale continuous coastal series of ENC's, and larger maximum display scale ENC data, all roads and tracks running down to the coastline should be encoded where the maximum display scale permits. Particular attention must be given to local roads serving minor piers, boat hards and landings. Inland, major roads within a few miles of the coast should be encoded to give a general indication of the degree of development, but tracks and all or some of the minor roads should be omitted. In largely undeveloped areas, with very few roads, it may be desirable to encode even minor roads inland.

On smaller maximum display scale ENC data, roads must be omitted.

If it is required to encode a road or track, it must be done using the feature **Road**.

Remarks:

- No remarks

Distinction: Causeway; railway.

6.15 Tunnel

IHO Definition: TUNNEL. A passage that is open to the atmosphere at both ends, buried under the seabed or laid over the sea floor or bored under the ground or through mountains. (S-57 Edition 3.1, Appendix A – Chapter 1, Page 1.191, November 2000).				
S-101 Geo Feature: Tunnel (TUNNEL)				
Primitives: Curve, Surface				
<i>Real World</i>		<i>Paper Chart Symbol</i>		<i>ECDIS Symbol</i>
S-101 Attribute	S-57 Acronym	Allowable Encoding Value	Type	Multiplicity
Condition	(CONDTN)	1 : under construction 2 : ruined 5 : planned construction	EN	0,1
Feature name			C	0,*
Display name			(S) BO	0,1
Language		ISO 639-3	(S) TE	0,1
Name	(OBJNAM) (NOBJNM)		(S) TE	1,1
Horizontal clearance fixed			C	0,1
Horizontal clearance value	(HORCLR)		(S) RE	1,1
Horizontal distance uncertainty	(HORACC)		(S) RE	0,1
Reported date	(SORDAT)	ISO 8601: 2004	TD	0,1
Status	(STATUS)	1 : permanent 3 : recommended 4 : not in use 6 : reserved 8 : private 14 : public	EN	0,*
Vertical clearance fixed			C	0,1
Vertical clearance value	(VERCLR)		(S) RE	1,1
Vertical uncertainty	(VERACC)		(S) C	0,1
Uncertainty fixed			(S) RE	1,1
Uncertainty variable			(S) RE	0,1
Vertical datum	(VERDAT)	3 : Mean sea level 16 : Mean high water 17 : Mean high water springs 18 : High water 19 : Approximate mean sea level 20 : High water springs 21 : Mean higher high water 24 : Local datum 25 : International great lakes datum 1985 26 : Mean water level 28 : Higher high water large	EN	0,1

		tide 29 : Nearly highest high water 30 : Highest astronomical tide (HAT)		
Scale minimum	(SCAMIN)	See clause X.X	IN	0,1
<p><u>INT 1 Reference:</u> D 16</p> <p>6.15.1 Tunnels (see S-4 – B-363.1)</p> <p>If it is required to encode a tunnel, it must be done using the feature Tunnel.</p> <p><u>Remarks:</u></p> <ul style="list-style-type: none"> • If there is a waterway inside the tunnel, and the waterway is navigable at the maximum display scale for the ENC data, it must be encoded as if it were a navigable canal (see clause X.X), using the features Depth Area or Dredged Area in conjunction with the Tunnel feature. There must be no Land Area feature in the area covering the waterway. • If it is required to encode a waterway inside a tunnel that is not navigable at the maximum display scale for the ENC data, it must be done using the feature Canal (see clause X.X) in conjunction with the Tunnel feature. A Land Area feature must cover the tunnel. The complex attributes horizontal clearance fixed and vertical clearance fixed must not be encoded on the Tunnel feature in this case. • If it is required to encode a tunnel that has no waterway inside it (but a railway, road etc), only the Tunnel feature must be encoded (the section of railway or road inside the tunnel must not be encoded), covered by Land Area, Depth Area, Dredged Area or Unsurveyed Area features as appropriate. The complex attributes horizontal clearance fixed and vertical clearance fixed must not be encoded on the Tunnel feature in this case. <p><u>Distinction:</u> Railway; road.</p>				

7 Geo Features – Landmarks

7.1 Buildings, landmarks, tanks, silos: Common encoding combinations

In the following table, the symbol '/' indicates that this attribute does not exist for that particular feature class. A blank indicates that the encoder may choose a relevant value for the attribute. The table contains the most common examples of coding; other coding combinations are possible.

Feature	INT1	Feature class	function	category of landmark	product	category of silo/tank
Administrative		Building	18	/	/	/
Bank office		Building	13	/	/	/
Boundary mark		Landmark		23	/	/
Buddhist temple	E16	Building	25	/	/	/
Bus station		Building	42	/	/	/
Cairn	Q100	Landmark	/	1	/	/
Cemetery	E19	Landmark		2	/	/
Chapel	E11	Building	21	/	/	/
Chimney	E22	Landmark		3	/	
Church	E10.1	Building	20	/	/	/
Church dome, Cupola	E10.4	Landmark	20	15	/	/
Church spire	E10.3	Landmark	20	20	/	/
Church tower	E10.2	Landmark	20	17	/	/
Clock tower		Landmark	38	17	/	/
Column	E24	Landmark	/	10	/	/
Communication mast		Landmark	29	7	/	/
Communication tower		Landmark	29	17	/	/
Control tower		Landmark	39	17	/	/
Cooling tower		Landmark	35	17	/	/
Cross, Calvary	E12	Landmark		14	/	/
Custom office	F61	Building	3	/	/	/
Dish aerial	E31	Landmark		4	/	/
Dome or cupola, part of a building		Landmark		15	/	/
Educational facility		Building	19	/	/	/
Factory		Building	16	/	/	/
Flagstaff, Flagpole	E27	Landmark		5	/	/
Flare stack on land	E23	Landmark		6	/	/
Grain elevator		Silo/Tank	/	/	22	3
Harbour-master's office	F60	Building	2	/	/	/
Headquarters for district control		Building	14	/	/	/
Health office	F62.1	Building	4	/	/	/
Hospital	F62.2	Building	5	/	/	/
Hotel	D6	Building	7	/	/	/

Feature	INT1	Feature class	function	category of landmark	product	category of silo/tank
House, Building	D5	Building		/	/	/
Large rock (or boulder) on land		Landmark	/	21	/	/
Light house (tower)	P1	Landmark	33	17	/	/
Light house (other shapes)	P1	Building	33	/	/	/
Lookout station in general		Building	28	/	/	/
Lookout tower		Landmark	28	17	/	/
Marabout	E18	Building	27	/	/	/
Mast in general		Landmark		7	/	/
Memorial plaque		Landmark		11	/	/
Microwave tower		Landmark	34	17	/	/
Minaret	E17	Landmark	26	20	/	/
Monument	E24	Landmark		9	/	/
Mooring mast		Landmark	40	7	/	/
Mosque	E17	Building	26	/	/	/
Obelisk	E24	Landmark	/	12	/	/
Observation tower		Landmark	36	17	/	/
Observation wheel		Landmark	/	24	/	/
Pagoda	E14	Building	23	/	/	/
Pilot lookout	T2	Building	12	/	/	/
Pilot office	T3	Building	11	/	/	/
Police station		Building	9	/	/	/
Post office	F63	Building	6	/	/	/
Power station		Building	17	/	/	/
Radar dome	E30.4	Landmark	32	15	/	/
Radar mast	E30.1	Landmark	32	7	/	/
Radar scanner	E30.3	Landmark		16	/	/
Radar tower	E30.2	Landmark	32	17	/	/
Radio mast	E28	Landmark	31	7	/	/
Radio tower	E29	Landmark	31	17	/	/
Railway station	D13	Building	8	/	/	/
Shinto shrine	E15	Building	24	/	/	/
Silo	E33	Silo/Tank	/	/		1
Spire, part of a building		Landmark		20	/	/
Stadium		Building	41	/	/	/
Statue	E24	Landmark		13	/	/
Tank	E32	Silo/Tank	/	/		2
Television mast	E28	Landmark	30	7	/	/
Television tower	E29	Landmark	30	17	/	/
Temple	E13	Building	22	/	/	/
Timeball tower		Landmark	37	17	/	/

Feature	INT1	Feature class	function	category of landmark	product	category of silo/tank
Torii		Landmark	/	25	/	/
Tower	E20	Landmark		17	/	/
Tower, part of a building		Landmark		17	/	/
Transit shed, Warehouse	F51	Building	15	/	/	/
Triangulation mark		Landmark		22	/	/
Water tower	E21	Silo/Tank	/	/	3 or 8	4
Water-police station		Building	10	/	/	/
Windmill	E25	Landmark		18	/	/

Remarks:

- If it is required to encode an offshore landmark (as defined by the attribute **category of landmark**), an ECDIS Base Display feature (for example **Pile, Land Area, Pontoon**) must also be encoded coincident to ensure the feature is always displayed on the ECDIS. Where fitted, lights should be encoded as described in clauses **X.X** to **X.X**, with the **Building, Wind Turbine, Landmark** or **Silo/Tank** being used as the structure feature for the relevant light equipment feature(s) (see clause **X.X.X**).
- For encoding wind turbines, see clause **X.X**.

7.2 Landmark

IHO Definition: **LANDMARK.** Any prominent object on land which can be used in determining a location or a direction. (IHO Dictionary – S-32).

S-101 Geo Feature: Landmark (LNDMRK)

Primitives: Point, Curve, Surface

Real World

Paper Chart Symbol

ECDIS Symbol

S-101 Attribute	S-57 Acronym	Allowable Encoding Value	Type	Multiplicity
Category of landmark	(CATLMK)	1 : cairn 2 : cemetery 3 : chimney 4 : dish aerial 5 : flagstaff (flagpole) 6 : flare stack 7 : mast 8 : windsock 9 : monument 10 : column (pillar) 11 : memorial plaque 12 : obelisk 13 : statue 14 : cross 15 : dome 16 : radar scanner 17 : tower 18 : windmill 20 : spire/minaret 21 : large rock (or boulder) on land 22 : triangulation mark 23 : boundary mark 24 : observation wheel 25 : torii	EN	1,*
Category of special purpose mark	(CATSPM)	16 : leading mark 17 : measured distance mark 41 : clearing mark	EN	0,*
Colour	(COLOUR)	1 : white 2 : black 3 : red 4 : green 5 : blue 6 : yellow 7 : grey 8 : brown 9 : amber 10 : violet 11 : orange 12 : magenta 13 : pink	EN	0,* (ordered)
Colour pattern	(COLPAT)	1 : horizontal stripes 2 : vertical stripes 3 : diagonal stripes 4 : squared	EN	0,1

		5 : stripes (direction unknown) 6 : border stripe		
Condition	(COND TN)	1 : under construction 2 : ruined 4 : wingless 5 : planned construction	EN	0,1
Elevation	(ELEVAT)		RE	0,1
Feature name			C	0,*
Display name			(S) BO	0,1
Language		ISO 639-3	(S) TE	0,1
Name	(OBJNAM) (NOBJNM)		(S) TE	1,1
Function	(FUNCTN)	2 : harbour-master's office 3 : custom office 4 : health office 5 : hospital 6 : post office 7 : hotel 8 : railway station 9 : police station 10 : water-police station 11 : pilot office 12 : pilot lookout 13 : bank office 14 : headquarters for district control 15 : transit shed/warehouse 16 : factory 17 : power station 18 : administrative 19 : educational facility 20 : church 21 : chapel 22 : temple 23 : pagoda 24 : Shinto shrine 25 : Buddhist temple 26 : mosque 27 : marabout 28 : lookout 29 : communication 30 : television 31 : radio 32 : radar 33 : light support 34 : microwave 35 : cooling 36 : observation 37 : timeball 38 : clock 39 : control 40 : airship mooring 41 : stadium 42 : bus station 44 : sea rescue control 45 : observatory 46 : ore crusher 47 : boathouse 48 : pumping station	EN	0,*
Height	(HEIGHT)		RE	0,1

Multiplicity of features			C	0,1
Multiplicity known			(S) BO	1,1
Number of features			(S) IN	0,1
Nature of construction	(NATCON)	1 : masonry 2 : concreted 3 : loose boulders 6 : wooden 7 : metal 8 : glass reinforced plastic (GRP) 11 : latticed 12 : glass	EN	0,*
Radar conspicuous	(CONRAD)		BO	0,1
Reported date	(SORDAT)	ISO 8601: 2004	TD	0,1
Status	(STATUS)	2 : occasional 4 : not in use 5 : periodic/intermittent 7 : temporary 8 : private 12 : illuminated 13 : historic 14 : public	EN	0,*
Vertical length	(VERLEN)		RE	0,1
Visually conspicuous	(CONVIS)	1 : visually conspicuous 2 : not visually conspicuous 3 : prominent	EN	1,1
Scale minimum	(SCAMIN)	See clause X.X	IN	0,1
In the water			BO	0,1

INT 1 Reference: D 8; E 10.2-10.4, 22-31; L 11; Q 100

7.2.1 Buildings, landmarks, tanks, silos (see S-4 – B-373; B-373.6; B-374.3-5; B-374.7; B-375.1-2; B-456.2; B-487.3)

Depending on height and the topographic relief, structures considered to be landmarks should be encoded up to several miles inland.

Waterfront, landmark and some public buildings should be encoded precisely and individually on the larger maximum display scale ENC data. When representing buildings generally, including urban and other built-up areas, the aim of the compiler must be to create the correct impression of the extent of the built-up area and the density of the buildings.

If it is required to encode a landmark (other than a tank or silo), it must be done using the feature **Landmark**.

Remarks:

- For buildings, see clause X.X; for silos, tanks and water towers, see clause X.X. For common encoding combinations, see clause X.X. For wind turbines, see clause X.X. For flare stacks on offshore platforms, see clause X.X.
- The feature association **Structure/Equipment** (see clause X.X) must only be used with **Landmark** features if the main purpose of the structure is to act as an aid to navigation (for example a lighthouse).
- A water tower must be encoded, where required, using the feature **Silo/Tank** (see clause X.X).
- A ruined landmark should be encoded in the same way as the feature in good condition, but with attribute **condition** = 2 (ruined).
- Radio and television masts and towers are likely to be visible over long distances and should be encoded as landmarks, even when well inland. They will usually carry air obstruction lights.
- To aid identification of landmarks by the mariner it may be useful to add the height of the top of the structure above ground level (**vertical length**) or above the general height datum (**height**).
- Buildings constructed as places of worship often form significant landmarks; their size and structure incorporating towers, spires, cupolas, etc often render them conspicuous. These buildings when known to

be prominent or conspicuous should be encoded up to several miles inland (see Figure below, examples (a) and (b)).

- The attribute **category of special purpose mark** should only be used if the **Landmark** is used as the front or rear lead for a transit, clearing line or measured distance, or for a leading line. Values for **category of special purpose mark** such as 16 (leading mark), 17 (measured distance mark) or 41 (clearing mark) in particular should be used for these purposes. See also clause X.X.
- For landmarks located in navigable water, the Boolean attribute **in the water** must be set to *True* to indicate that the feature is to be included in the ECDIS Base Display. Where such structures are located in the water it is not required to encode any supporting structures (for example piles).
- When a building is shown as a surface, indicating its true shape, and it is required to encode a prominent feature such as a tower or spire that is part of the structure, two features must be created (see Figure below):
 - a **Building** feature of type surface for the main building,
 - a **Landmark** feature of type point for the prominent feature.

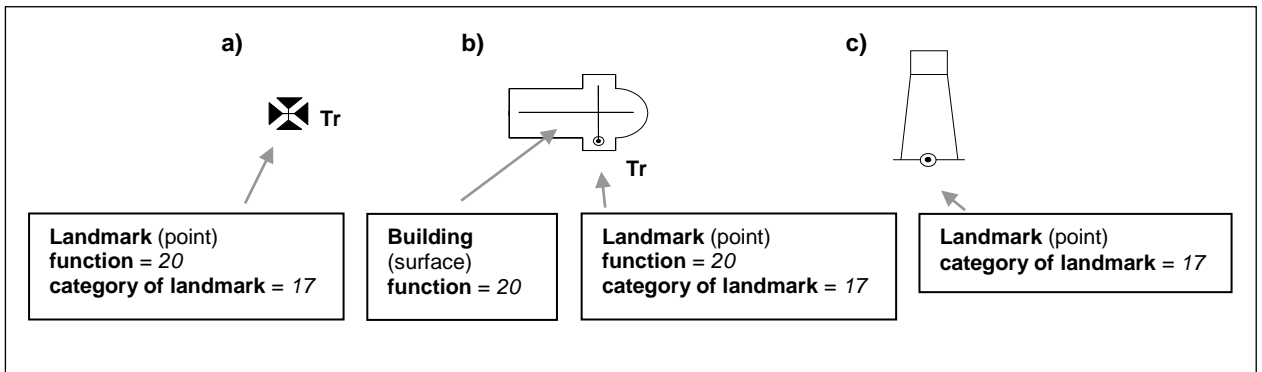

- Not all landmarks are visually conspicuous. If a feature is visually conspicuous (that is, it is distinctly and noticeably visible from seaward), the attribute **visually conspicuous** must be encoded (see S-4 – B-340).

Distinction: Beacon special purpose/general; building single; daymark; pylon/bridge support; silo/tank; wind turbine.

Feature/Information associations							
Type	Association Name	Association Ends					
		Class	Role	Mult	Class	Role	Mult
Comp	Structure/Equipment	Landmark	Supported by	0,1	Daymark, Fog Signal, Light Air Obstruction, Light All Around, Light Fog Detector, Light Sectored, Physical AIS Aid to Navigation, Radar Transponder Beacon, Retroreflector, Signal Station Traffic, Signal Station Warning	Supports	1,*
Aggr	Range System Aggregation	Landmark	Consists of	1,*	Range System	Component of	0,1

7.3 Silo/tank

IHO Definition: SILO/TANK. A large storage structure used for storing loose materials, liquids and/or gases. (Adapted from Defence Geospatial Information Working Group; Feature Data Dictionary Register, 2012).				
S-101 Geo Feature: Silo/tank (SILTNK)				
Primitives: Point, Surface				
<i>Real World</i>		<i>Paper Chart Symbol</i>		<i>ECDIS Symbol</i>
S-101 Attribute	S-57 Acronym	Allowable Encoding Value	Type	Multiplicity
Building shape	(BUIHP)	5 : high-rise building 6 : pyramid 7 : cylindrical 8 : spherical 9 : cubic	EN	0,1
Category of silo/tank	(CATSIL)	1: silo in general 2: tank in general 3: grain elevator 4: water tower	EN	0,1
Colour	(COLOUR)	1 : white 2 : black 3 : red 4 : green 5 : blue 6 : yellow 7 : grey 8 : brown 9 : amber 10 : violet 11 : orange 12 : magenta 13 : pink	EN	0,* (ordered)
Colour pattern	(COLPAT)	1 : horizontal stripes 2 : vertical stripes 3 : diagonal stripes 4 : squared 5 : stripes (direction unknown) 6 : border stripe	EN	0,1
Condition	(CONDTN)	1 : under construction 2 : ruined 5 : planned construction	EN	0,1
Elevation	(ELEVAT)		RE	0,1
Feature name			C	0,*
Display name			(S) BO	0,1
Language		ISO 639-3	(S) TE	0,1
Name	(OBJNAM) (NOBJNM)		(S) TE	1,1
Height	(HEIGHT)		RE	0,1
Multiplicity of features			C	0,1

Multiplicity known			(S) BO	1,1
Number of features			(S) IN	0,1
Nature of construction	(NATCON)	1 : masonry 2 : concreted 6 : wooden 7 : metal 8 : glass reinforced plastic (GRP)	EN	0,*
Product	(PRODCT)	1 : oil 2 : gas 3 : water 5 : coal 7 : chemicals 8 : drinking water 9 : milk 13 : salt 14 : sand 16 : sawdust/wood chips 18 : liquefied natural gas (LNG) 19 : liquefied petroleum gas (LPG) 20 : wine 21 : cement 22 : grain 23 : ice	EN	0,*
Radar conspicuous	(CONRAD)		BO	0,1
Reported date	(SORDAT)	ISO 8601: 2004	TD	0,1
Status	(STATUS)	4 : not in use 12 : illuminated 13 : historic	EN	0,*
Vertical length	(VERLEN)		RE	0,1
Visually conspicuous	(CONVIS)	1 : visually conspicuous 2 : not visually conspicuous 3 : prominent	EN	0,1
Scale minimum	(SCAMIN)	See clause X.X	IN	0,1
In the water			BO	0,1

INT 1 Reference: E 2, 32-33

7.3.1 Tanks, silos (see S-4 – B-340.2 and B-376)

Isolated tanks or gasholders may be good landmarks and should be represented true to scale (that is, as surface) where possible, to enable them to be used as fixing marks. Groups of tanks, as at a refinery, may be useful for general identification of position but cannot usually be used for precise position-fixing because of uncertainty of the location of individual tanks.

If it is required to encode a tank or silo, it must be done using the feature **Silo/Tank**.

Remarks:

- For buildings, see clause X.X; for landmarks, see clause X.X. For common encoding combinations, see clause X.X.
- Groups of silos or tanks (tank farm) in close proximity must be encoded, where required, using the feature **Production/Storage Area** (see clause X.X). Individual, visually conspicuous silos, or tanks within a tank farm, may be encoded as **Silo/Tank** within the **Production/Storage Area**. Multiple silos contained within a single structure may be indicated using the complex attribute **multiplicity of features**.
- For tanks or silos located in or over navigable water, the Boolean attribute **in the water** must be set to *True* to indicate that the feature is to be included in the ECDIS Base Display. Where such structures are located in the water it is not required to encode any supporting structures (for example piles).

Distinction: Building; landmark; production/storage area.

Feature/Information associations

Type	Association Name	Association Ends					
		Class	Role	Mult	Class	Role	Mult
Comp	Structure/Equipment	Silo/Tank	Supported by	0,1	Daymark, Fog Signal, Light Air Obstruction, Light All Around, Light Fog Detector, Light Sectored, Physical AIS Aid to Navigation, Radar Transponder Beacon, Retroreflector, Signal Station Traffic, Signal Station Warning	Supports	1,*
Aggr	Range System Aggregation	Silo/Tank	Consists of	1,*	Range System	Component of	0,1

7.4 Wind turbine

IHO Definition: **WIND TURBINE.** A structure consisting of a tower with rotating blades. Wind turbines convert kinetic energy of the wind into mechanical energy and electricity.

S-101 Geo Feature: Wind turbine

Primitives: Point

Real World

Paper Chart Symbol

ECDIS Symbol

S-101 Attribute	S-57 Acronym	Allowable Encoding Value	Type	Multiplicity
Colour	(COLOUR)	1 : white 2 : black 3 : red 4 : green 5 : blue 6 : yellow 7 : grey 8 : brown 9 : amber 10 : violet 11 : orange 12 : magenta 13 : pink	EN	0,* (ordered)
Colour pattern	(COLPAT)	1 : horizontal stripes 2 : vertical stripes 3 : diagonal stripes 4 : squared 5 : stripes (direction unknown) 6 : border stripe	EN	0,1
Condition	(CONDTN)	1 : under construction 4 : wingless 5 : planned construction	EN	0,1
Elevation	(ELEVAT)		RE	0,1
Feature name			C	0,*
Display name			(S) BO	0,1
Language		ISO 639-3	(S) TE	0,1
Name	(OBJNAM) (NOBJNM)		(S) TE	1,1
Fixed date range			C	0,1
Date end	(DATEND)	ISO 8601: 2004	(S) TD	0,1
Date start	(DATSTA)	ISO 8601: 2004	(S) TD	0,1
Height	(HEIGHT)		RE	0,1
Multiplicity of features			C	0,1
Multiplicity known			(S) BO	1,1
Number of features			(S) IN	0,1
Nature of construction	(NATCON)	2 : concreted 6 : wooden	EN	0,*

		7 : metal 8 : glass reinforced plastic (GRP) 11 : latticed		
Radar conspicuous	(CONRAD)		BO	0,1
Reported date	(SORDAT)	ISO 8601: 2004	TD	0,1
Status	(STATUS)	1 : permanent 2 : occasional 4 : not in use 5 : periodic/intermittent 7 : temporary 8 : private 12 : illuminated 13 : historic 14 : public 28 : buoyed	EN	0,*
Vertical clearance fixed			C	0,1
Vertical clearance value	(VERCLR)		(S) RE	1,1
Vertical uncertainty	(VERACC)		(S) RE	0,1
Uncertainty fixed			(S) RE	1,1
Uncertainty variable			(S) RE	0.1
Vertical datum	(VERDAT)	3 : Mean sea level 16 : Mean high water 17 : Mean high water springs 18 : High water 19 : Approximate mean sea level 20 : High water springs 21 : Mean higher high water 24 : Local datum 25 : International great lakes datum 1985 26 : Mean water level 28 : Higher high water large tide 29 : Nearly highest high water 30 : Highest astronomical tide (HAT)	EN	0,1
Vertical length	(VERLEN)		RE	0,1
Visually conspicuous	(CONVIS)	1 : visually conspicuous 2 : not visually conspicuous 3 : prominent	EN	0,1
Water level effect	(WATLEV)	2 : always dry 7 : floating	EN	0,1
Scale minimum	(SCAMIN)	See clause X.X	IN	0,1
In the water			BO	0,1

INT 1 Reference: L 2, 10-15, 17

7.4.1 Wind turbines (see S-4 – B-374.6; B-445.8-9)

Wind turbines are generally tall, multi-bladed structures, usually with two or three blades, which may pose as obstacles to navigation if located offshore but are often visible over long distances and therefore useful as visual references. Their purpose is to generate electricity for large communities, or to feed a national grid. They are often in groups (known as wind farms). Floating wind turbines are held in position by ground tackle and consequently may be subject to significant lateral and some vertical movement.

If it is required to encode a wind turbine, it must be done using the feature **Wind Turbine**.

Remarks:

- The attribute **elevation** is only applicable for wind turbines on land.
- To aid identification of wind turbines on land by the mariner it may be useful to add the height of the top of the structure above ground level (**vertical length**) or above the general height datum (**height**).
- For offshore wind turbines, the Boolean attribute **in the water** must be set to *True* to indicate that the feature is to be included in the ECDIS Base Display. Where such structures are located in the water it is not required to encode any supporting structures (for example piles).
- For offshore wind turbines (attribute **in the water** = *True*), the attribute **height** is only relevant for fixed turbines, and is referred to the vertical datum (see clause X.X).
- For offshore wind turbines, the attribute **vertical length** is only relevant for floating wind turbines, and is referred to the sea level.
- A ruined wind turbine should be encoded in the same way as the feature in good condition, but with attribute **condition** = 4 (wingless).
- If it is required to encode sites of dismantled offshore wind turbines, this must be done using **Foul Ground** features (see clause X.X), unless the source indicates that any remaining structure protrudes far enough above the seabed so as to be an obstruction to surface navigation, in which case this must be encoded using an **Obstruction** feature (see clause X.X).
- If it is required to encode an offshore wind farm, it must be done using the feature **Offshore Production Area** (see clause X.X). An onshore wind farm must be encoded, where required, using the feature **Production/Storage Area** (see clause X.X).
- Wind turbines may carry lights (see clause X.X) or fog signals (see clause X.X). Where fitted, lights should be encoded as described in clauses X.X to X.X, with the **Wind Turbine** being used as the structure feature for the light equipment feature(s).
- For encoding offshore safety zones around offshore wind turbines, see clause X.X.

Distinction: Beacon special purpose/general; building single; daymark; landmark; pylon/bridge support; silo/tank.

Feature/Information associations							
Type	Association Name	Association Ends					
		Class	Role	Mult	Class	Role	Mult
Comp	Structure/Equipment	Wind Turbine	Supported by	0,1	Daymark, Fog Signal, Light Air Obstruction, Light All Around, Light Fog Detector, Light Sectored, Physical AIS Aid to Navigation, Radar Transponder Beacon, Retroreflector, Signal Station Traffic, Signal Station Warning	Supports	1,*

7.5 Fortified structure

IHO Definition: **FORTIFIED STRUCTURE**. A structure that is specifically designed or reinforced to provide for defence from armed attack. (Adapted from Defence Geospatial Information Working Group; Feature Data Dictionary Register, 2010).

S-101 Geo Feature: Fortified structure (FORSTC)

Primitives: Point, Curve, Surface

Real World

Paper Chart Symbol

ECDIS Symbol

S-101 Attribute	S-57 Acronym	Allowable Encoding Value	Type	Multiplicity
Category of fortified structure	(CATFOR)	1 : castle 2 : fort 3 : battery 4 : blockhouse 5 : fortified tower 6 : redoubt 8 : fortified submarine shelter 9 : rampart	EN	0,1
Condition	(CONDTN)	1 : under construction 2 : ruined	EN	0,1
Feature name			C	0,*
Display name			(S) BO	0,1
Language		ISO 639-3	(S) TE	0,1
Name	(OBJNAM) (NOBJNM)		(S) TE	1,1
Height	(HEIGHT)		RE	0,1
Nature of construction	(NATCON)	1 : masonry 2 : concreted 3 : loose boulders 6 : wooden 7 : metal	EN	0,*
Radar conspicuous	(CONRAD)		BO	0,1
Reported date	(SORDAT)	ISO 8601: 2004	TD	0,1
Status	(STATUS)	4 : not in use 7 : temporary 8 : private 12 : illuminated 13 : historic 14 : public 28 : buoyed	EN	0,*
Vertical length	(VERLEN)		RE	0,1
Visually conspicuous	(CONVIS)	1 : visually conspicuous 2 : not visually conspicuous 3 : prominent	EN	0,1
Scale minimum	(SCAMIN)	See clause X.X	IN	0,1
In the water			BO	0,1

INT 1 Reference: E 34.1-3

7.5.1 Fortified structures (see S-4 – B-379)

Some coastlines have prominent defensive structures, often disused, decayed, or used for non-defence purposes. Such structures range from major castles and forts to minor lookout posts and may be the main distinctive features of headlands or stretches of coastline. National regulations permitting, any such features as are likely to be visible from seaward and should be encoded on the largest maximum display scale ENC data.

If it is required to encode a fortified structure, it must be done using the feature **Fortified Structure**.

Remarks:

- If it is required to encode a Martello tower, it must be done using **Fortified Structure** with attribute **category of fort = 5** (fortified tower).
- Where fitted, lights should be encoded as described in clauses X.X to X.X, with the **Fortified Structure** being used as the structure feature for the relevant light equipment feature(s) (see clause X.X.X).
- For fortified structures located in navigable water, the Boolean attribute **in the water** must be set to *True* to indicate that the feature is to be included in the ECDIS Base Display. Where such structures are located in the water it is not required to encode any supporting structures (for example piles).

Distinction: Building; fence/wall; landmark.

Feature/Information associations

Type	Association Name	Association Ends					
		Class	Role	Mult	Class	Role	Mult
Comp	Structure/Equipment	Fortified Structure	Supported by	0,1	Daymark, Fog Signal, Light Air Obstruction, Light All Around, Light Fog Detector, Light Sectored, Physical AIS Aid to Navigation, Radar Transponder Beacon, Retroreflector, Signal Station Traffic, Signal Station Warning	Supports	1,*
Aggr	Range System Aggregation	Fortified Structure	Consists of	1,*	Range System	Component of	0,1

7.6 Production/storage area

IHO Definition: PRODUCTION/STORAGE AREA. An area on land for the exploitation or storage of natural resources. (S-57 Edition 3.1, Appendix A – Chapter 1, Page 1.124, November 2000).				
S-101 Geo Feature: Production/storage area (PRDARE)				
Primitives: Point, Surface				
<i>Real World</i>		<i>Paper Chart Symbol</i>		<i>ECDIS Symbol</i>
S-101 Attribute	S-57 Acronym	Allowable Encoding Value	Type	Multiplicity
Category of production area	(CATPRA)	1 : quarry 2 : mine 3 : stockpile 4 : power station area 5 : refinery area 6 : timber yard 7 : factory area 8 : tank farm 9 : wind farm 10 : slag heap/spoil heap 11 : production plant	EN	1,1
Condition	(COND TN)	1 : under construction 2 : ruined 3 : under reclamation 5 : planned construction	EN	0,1
Elevation	(ELEVAT)		RE	0,1
Feature name			C	0,*
Display name			(S) BO	0,1
Language		ISO 639-3	(S) TE	0,1
Name	(OBJNAM) (NOBJNM)		(S) TE	1,1
Fixed date range			C	0,1
Date end	(DATEND)	ISO 8601: 2004	(S) TD	0,1
Date start	(DATSTA)	ISO 8601: 2004	(S) TD	0,1
Height	(HEIGHT)		RE	0,1
Product	(PRODCT)	1 : oil 2 : gas 3 : water 4 : stone 5 : coal 6 : ore 7 : chemicals 8 : drinking water 9 : milk 10 : bauxite 11 : coke 12 : iron ingots 13 : salt 14 : sand 15 : timber 16 : sawdust/wood chips	EN	0,*

		17 : scrap metal 18 : liquefied natural gas (LNG) 19 : liquefied petroleum gas (LPG) 20 : wine 21 : cement 22 : grain 23 : electricity 25 : clay		
Radar conspicuous	(CONRAD)		BO	0,1
Reported date	(SORDAT)	ISO 8601: 2004	TD	0,1
Status	(STATUS)	4 : not in use 12 : illuminated	EN	0,*
Vertical length	(VERLEN)		RE	0,1
Visually conspicuous	(CONVIS)	1 : visually conspicuous 2 : not visually conspicuous 3 : prominent	EN	0,1
Scale minimum	(SCAMIN)	See clause X.X	IN	0,1

INT 1 Reference: E 26.2, 35.1-2, 36; F 52

7.6.1 Production and storage areas (see S-4 – B-328.2; 367; 374.6)

Production or storage areas located in close proximity to the coast are often prominent landmarks used by mariners to assist in position-fixing. Features such as quarry faces, stockpiles, power stations, refineries, timber stacks in timber yards, factories, groups of tanks, groups of wind turbines, and slag heaps should be shown on the largest maximum display scale ENC data.

If it is required to encode production or storage area, it must be done using the feature **Production/Storage Area**.

Remarks:

- If there are individual buildings or equipment features contained within this area, they should be encoded as separate features such as **Building, Crane, Landmark** or **Silo/Tank** within the **Production/Storage Area** feature of type surface if the maximum display scale of the ENC data permits.
- If visible from seaward, a quarry face should be encoded as for a cliff (see clause **X.X**), with attribute **category of slope = 6** (cliff).

Distinction: Free port area; offshore production area.

8 Geo Features – Ports

8.1 Works in progress and projected (see S-4 – B-329)

An ENC can seldom show the exact state of work under construction because it may not be known by the encoder and, even if known, may be expected to change between ENC updates (see clause X.X). Where it is possible to provide the mariner with an indication of the status of work under construction, under reclamation or planned, it must be done using the appropriate feature (for example **Shoreline Construction, Causeway, Dock Area, Dry Dock, Pipeline Submarine/On Land**), with the attribute **condition** populated as 1 (under construction), 3 (under reclamation) or 5 (planned construction). Where the encoder wishes to provide such information to the mariner and the details of the works are not known (nature and extent of the works), this should be done using the feature **Caution Area** (see clause X.X), with known details of the works encoded using an associated instance of the information class **Nautical Information** (see clause X.X), complex attribute **information**.

If it is required to provide the mariner with an indication of the date to which information regarding the works is current, it must be done using the attribute **reported date** (see clause X.X).

The coastline existing before the beginning of the works should remain encoded as a **Coastline** or **Shoreline Construction** feature until the completion of the works.

As the works progress and further information is supplied to the Producing Authority, ENC datasets should be updated appropriately through the issue of updates to the dataset or publication of new editions of the dataset (see clause X.X).

On completion of the works, full encoding of the of the new feature(s) in accordance with the relevant clauses in this document must be achieved, and incorporated in the relevant ENC dataset through the issue of an update to the dataset or publication of a new edition of the dataset (see clause X.X).

8.1.1 Works on land (see S-4 – B-329.1)

Features likely to be prominent from seaward should be encoded as described above, where possible. New docks, locks, canals, etc, being excavated should be encoded similarly. The works must be covered by the feature **Land Area** (see clause X.X) until completion of the works.

8.1.2 Works at sea (see S-4 – B-329.2-5)

Works at sea which will extend the coastline seaward, where the line of the future coastline (including piers, etc) is known, must be encoded, where required, as described in clause 8.1 above, using the appropriate features. The existing coastline should remain until the works are completed and the new coastline has been established. The area of reclamation or construction must also be covered by the appropriate feature(s) from the Skin of the Earth. This may be **Depth Area** at commencement of the works, or if the works are planned and have not yet commenced; **Unsurveyed Area** while reclamation/construction is in progress but the area is still covered by water; or **Land Area** where the area of the works has been reclaimed (that is, is always dry).

Works at sea which will be wholly or partly submerged when completed, such as training walls or pipelines must be encoded, if required, using the appropriate feature relevant to the completed feature, in accordance with clause 8.1 above. The appropriately attributed depth information, if known, or **Unsurveyed Area**, must cover the works as appropriate.

Where the extent or nature of the works is unknown, they must be encoded, where required, using the feature **Caution Area** as described in clause 8.1 above.

Because lights and buoys marking the limits of works at sea may be moved without notice, they should be encoded only where it is considered safe to do so. Alternatively, this information may be included by encoding an associated instance of the information class **Nautical Information** (see clause X.X), complex attribute **information**, sub-attribute **text**, for instance, *Outer end marked by red lights*.

8.2 Checkpoint

IHO Definition: **CHECKPOINT**. An official location at which to register, declare and/or inspect goods and/or people. (Adapted from Defence Geospatial Information Working Group; Feature Data Dictionary Register, 2010).

S-101 Geo Feature: Checkpoint (CHKPNT)

Primitives: Point, Surface

Real World

Paper Chart Symbol

ECDIS Symbol

S-101 Attribute	S-57 Acronym	Allowable Encoding Value	Type	Multiplicity
Category of checkpoint	(CATCHP)	1 : custom	EN	0,1
Feature name			C	0,*
Display name			(S) BO	0,1
Language		ISO 639-3	(S) TE	0,1
Name	(OBJNAM) (NOBJNM)		(S) TE	1,1
Status	(STATUS)	1 : permanent 2 : occasional 5 : periodic/intermittent 7 : temporary 9 : mandatory 12 : illuminated	EN	0,*
Scale minimum	(SCAMIN)	See clause X.X	IN	0,1

INT 1 Reference:

8.2.1 Checkpoints

If it is required to encode an official place to register, declare and/or check goods and people, it must be done using the feature **Checkpoint**.

Remarks:

- The **Checkpoint** must only be used to encode the function. In addition, if it is required to encode a physical feature (for example building, fence, gate), it must be done using an appropriate feature (for example **Building, Landmark**).

Distinction: Custom zone.

8.3 Hulks

IHO Definition: **HULK.** A vessel which is permanently moored or aground. It may be abandoned or put to some other use. Its fittings and superstructure may have been removed. (Adapted from IHO Dictionary – S-32).

S-101 Geo Feature: Hulk (HULKES)

Primitives: Point, Surface

Real World

Paper Chart Symbol

ECDIS Symbol

S-101 Attribute	S-57 Acronym	Allowable Encoding Value	Type	Multiplicity
Category of hulk	(CATHLK)	1 : floating restaurant 2 : historic ship 3 : floating museum 4 : floating accommodation 5 : floating breakwater 6 : casino 7 : training vessel	EN	0,*
Colour	(COLOUR)	1 : white 2 : black 3 : red 4 : green 5 : blue 6 : yellow 7 : grey 8 : brown 9 : amber 10 : violet 11 : orange 12 : magenta 13 : pink	EN	0,* (ordered)
Colour pattern	(COLPAT)	1 : horizontal stripes 2 : vertical stripes 3 : diagonal stripes 4 : squared 5 : stripes (direction unknown) 6 : border stripe	EN	0,1
Condition	(CONDTN)	1 : under construction 2 : ruined 5 : planned construction	EN	0,1
Feature name			C	0,*
Display name			(S) BO	0,1
Language		ISO 639-3	(S) TE	0,1
Name	(OBJNAM) (NOBJNM)		(S) TE	1,1
Horizontal length	(HORLEN)		RE	0,1
Horizontal width	(HORWID)		RE	0,1
Radar conspicuous	(CONRAD)		BO	0,1
Reported date	(SORDAT)	ISO 8601: 2004	TD	0,1

Vertical length	(VERLEN)		RE	0,1
Visually conspicuous	(CONVIS)	1 : visually conspicuous 2 : not visually conspicuous 3 : prominent	EN	0,1
Scale minimum	(SCAMIN)	See clause X.X	IN	0,1
<p><u>INT 1 Reference:</u> F 34</p> <p>8.3.1 Hulks (see S-4 – B-330)</p> <p>If it is required to encode a permanently moored ship, it must be done using the feature Hulk.</p> <p><u>Remarks:</u></p> <ul style="list-style-type: none"> • A Hulk feature of type surface must not be bound by curve features Coastline or Shoreline Construction, unless the edge associated with the curve feature is also the boundary of a Land Area feature of type surface. • If it is required to encode a floating production, storage and off-loading vessel, it must be done using the feature Offshore Platform (see clause X.X), with attribute category of offshore platform = 8 (floating production, storage and off-loading vessel (FPSO)). • If it is required to encode a hulk serving the purpose of a floating breakwater, it must be done using a Hulk feature, with attribute category of hulk = 5 (floating breakwater). If it is required to encode a floating breakwater of any other construction, it must be done using the feature Shoreline Construction (see clause X.X), with attributes category of shoreline construction = 1 (breakwater) and water level effect = 7 (floating). <p><u>Distinction:</u> Offshore platform; shoreline construction; wreck.</p>				

Feature/Information associations							
Type	Association Name	Association Ends					
		Class	Role	Mult	Class	Role	Mult
Comp	Structure/Equipment	Hulk	Supported by	0,1	Daymark, Fog Signal, Light Air Obstruction, Light All Around, Light Fog Detector, Light Sector, Physical AIS Aid to Navigation, Radar Transponder Beacon, Retroreflector, Signal Station Traffic, Signal Station Warning	Supports	1,*

8.4 Piles

IHO Definition: PILE. A long heavy timber or section of steel, wood, concrete, etc., forced into the earth or seabed which may serve as a support, as for a pier, or a free standing pole within a marine environment. (IHO Dictionary – S-32).				
S-101 Geo Feature: Pile (PILPNT)				
Primitives: Point, Curve, Surface				
<i>Real World</i>		<i>Paper Chart Symbol</i>		<i>ECDIS Symbol</i>
S-101 Attribute	S-57 Acronym	Allowable Encoding Value	Type	Multiplicity
Category of pile	(CATPLE)	1 : stake 3 : post 4 : tripodal 5 : piling 6 : area of piles 7 : pipe	EN	0,1
Colour	(COLOUR)	1 : white 2 : black 3 : red 4 : green 5 : blue 6 : yellow 7 : grey 8 : brown 9 : amber 10 : violet 11 : orange 12 : magenta 13 : pink	EN	0,* (ordered)
Colour pattern	(COLPAT)	1 : horizontal stripes 2 : vertical stripes 3 : diagonal stripes 4 : squared 5 : stripes (direction unknown) 6 : border stripe	EN	0,1
Condition	(CONDTN)	1 : under construction 2 : ruined 5 : planned construction	EN	0,1
Feature name			C	0,*
Display name			(S) BO	0,1
Language		ISO 639-3	(S) TE	0,1
Name	(OBJNAM) (NOBJNM)		(S) TE	1,1
Fixed date range			C	0,1
Date end	(DATEND)	ISO 8601: 2004	(S) TD	0,1
Date start	(DATSTA)	ISO 8601: 2004	(S) TD	0,1
Height	(HEIGHT)		RE	0,1
Radar conspicuous	(CONRAD)		BO	0,1

Reported date	(SORDAT)	ISO 8601: 2004	TD	0,1
Status	(STATUS)	1 : permanent 4 : not in use 6 : reserved 7 : temporary 8 : private 12 : illuminated 14 : public	EN	0,*
Vertical length	(VERLEN)		RE	0,1
Visually conspicuous	(CONVIS)	1 : visually conspicuous 2 : not visually conspicuous 3 : prominent	EN	0,1
Scale minimum	(SCAMIN)	See clause X.X	IN	0,1

INT 1 Reference: F 22

8.4.1 Piles (see S-4 – B-327.3)

If it is required to encode a pile or post that is not used as a mooring/warping facility or an aid to navigation, it must be done using the feature **Pile**.

Remarks:

- Stumps of piles or posts that are dangerous to navigation must be encoded, where required, using **Obstruction** features (see clause X.X), with attribute **category of obstruction** = 1 (snag/stump), and must not be encoded using **Pile**.
- **Pile** of type curve must only be used for **Pile** having **category of pile** = 5 (piling), which is sometimes termed “row of piles” or “sheet piling”. Point primitive may be used to encode piling for smaller maximum display scale ENC data.
- **Pile** of type surface must only be used for **Pile** having **category of pile** = 6 (area of piles). Point primitive may be used to encode an area of piles for smaller maximum display scale ENC data.
- Stakes and posts that are identified on the source to serve the purpose of aids to navigation must be encoded, where required, using the appropriate beacon feature (for example **Beacon Special Purpose/General**), with attribute **beacon shape** = 1 (stake, pole, perch, post).
- See clause X.X for details of how to encode a pile or post that is used as a mooring/warping facility.

Distinction: Beacon cardinal; beacon isolated danger; beacon lateral; beacon safe water; beacon special purpose/general; mooring/warping facility.

Feature/Information associations							
Type	Association Name	Association Ends					
		Class	Role	Mult	Class	Role	Mult
Comp	Structure/Equipment	Pile	Supported by	0,1	Daymark, Fog Signal, Light Air Obstruction, Light All Around, Light Fog Detector, Light Sected, Physical AIS Aid to Navigation, Radar Transponder Beacon, Retroreflector, Signal Station Traffic, Signal Station Warning	Supports	1,*
Aggr	Range System Aggregation	Pile	Consists of	1,*	Range System	Component of	0,1
Asso	Aids to Navigation Association	Pile	Consists of	1,*	Archipelagic Sea lane, Fairway System, Bridge, Deep Water Route, Two-Way	Component of	0,1

					Route		
--	--	--	--	--	--------------	--	--

8.5 Dyke

IHO Definition: **DYKE.** A dyke (or dike) is an artificial embankment to contain or hold back water. (IHO Dictionary – S-32).

S-101 Geo Feature: Dyke (DYKCON)

Primitives: Curve, Surface

Real World

Paper Chart Symbol

ECDIS Symbol

S-101 Attribute	S-57 Acronym	Allowable Encoding Value	Type	Multiplicity
Condition	(CONDTN)	1 : under construction 2 : ruined 3 : under reclamation 5 : planned construction	EN	0,1
Feature name			C	0,*
Display name			(S) BO	0,1
Language		ISO 639-3	(S) TE	0,1
Name	(OBJNAM) (NOBJNM)		(S) TE	1,1
Fixed date range			C	0,1
Date end	(DATEND)	ISO 8601: 2004	(S) TD	0,1
Date start	(DATSTA)	ISO 8601: 2004	(S) TD	0,1
Height	(HEIGHT)		RE	0,1
Nature of construction	(NATCON)	1 : masonry 2 : concreted 3 : loose boulders 4 : hard surfaced 5 : unsurfaced 6 : wooden 7 : metal	EN	0,*
Radar conspicuous	(CONRAD)		BO	0,1
Reported date	(SORDAT)	ISO 8601: 2004	TD	0,1
Vertical length	(VERLEN)		RE	0,1
Visually conspicuous	(CONVIS)	1 : visually conspicuous 2 : not visually conspicuous 3 : prominent	EN	0,1
Scale minimum	(SCAMIN)	See clause X.X	IN	0,1

INT 1 Reference: F 1

8.5.1 Dykes (see S-4 – B-313.1)

Dykes and seawalls are primarily designed to prevent inundation, and generally have regular outlines.

If it is required to encode a dyke, it must be done using the feature **Dyke**.

Remarks:

- If it is required to encode a dyke whose seaward edge is coincident with the coastline, it must be done using **Dyke**, and with a **Shoreline Construction** feature of type curve along its seaward edge, with no value populated for attribute **category of shoreline construction**.

- When a **Dyke** feature is of type surface, it must be covered by a **Land Area** feature.
- At large compilation scales, the dyke crown (the topline of the dyke) may be encoded as a **Slope Topline** feature (see clause X.X), with attribute **category of slope** = 2 (embankment).

Distinction: Dam; sloping ground; slope topline.

8.6 Shoreline construction

IHO Definition: **SHORELINE CONSTRUCTION**. A fixed artificial structure in the water and/or adjoining the land. It may also refer to features such as training walls, which are not necessarily connected to, nor form part of the shoreline. (S-57 Edition 3.1, Appendix A – Chapter 1, Page 1.154, November 2000, as amended).

S-101 Geo Feature: Shoreline construction (SLCONS)

Primitives: Point, Curve, Surface

<i>Real World</i>	<i>Paper Chart Symbol</i>	<i>ECDIS Symbol</i>
-------------------	---------------------------	---------------------

S-101 Attribute	S-57 Acronym	Allowable Encoding Value	Type	Multiplicity
Category of shoreline construction	(CATSLC)	1 : breakwater 2 : groyne (groin) 3 : mole 4 : pier (jetty) 5 : promenade pier 6 : wharf (quay) 7 : training wall 8 : rip rap 9 : revetment 10 : sea wall 11 : landing steps 12 : ramp 13 : slipway 14 : fender 15 : solid face wharf 16 : open face wharf 17 : log ramp 20 : swimming facility	EN	0,1
Colour	(COLOUR)	1 : white 2 : black 3 : red 4 : green 5 : blue 6 : yellow 7 : grey 8 : brown 9 : amber 10 : violet 11 : orange 12 : magenta 13 : pink	EN	0,* (ordered)
Colour pattern	(COLPAT)	1 : horizontal stripes 2 : vertical stripes 3 : diagonal stripes 4 : squared 5 : stripes (direction unknown) 6 : border stripe	EN	0,1
Condition	(CONDTN)	1 : under construction 2 : ruined 3 : under reclamation 5 : planned construction	EN	0,1
Feature name			C	0,*

Display name			(S) BO	0,1
Language		ISO 639-3	(S) TE	0,1
Name	(OBJNAM) (NOBJNM)		(S) TE	1,1
Fixed date range			C	0,1
Date end	(DATEND)	ISO 8601: 2004	(S) TD	0,1
Date start	(DATSTA)	ISO 8601: 2004	(S) TD	0,1
Height	(HEIGHT)		RE	0,1
Horizontal clearance fixed			C	0,1
Horizontal clearance value	(HORCLR)		(S) RE	1,1
Horizontal distance uncertainty	(HORACC)		(S) RE	0,1
Horizontal length	(HORLEN)		RE	0,1
Horizontal width	(HORWID)		RE	0,1
Nature of construction	(NATCON)	1 : masonry 2 : concreted 3 : loose boulders 4 : hard surfaced 5 : unsurfaced 6 : wooden 7 : metal 8 : glass reinforced plastic (GRP) 11 : latticed	EN	0,*
Radar conspicuous	(CONRAD)		BO	0,1
Reported date	(SORDAT)	ISO 8601: 2004	TD	0,1
Status	(STATUS)	1 : permanent 2 : occasional 3 : recommended 4 : not in use 6 : reserved 7 : temporary 8 : private 12 : illuminated 13 : historic 14 : public 28 : buoyed	EN	0,*
Vertical length	(VERLEN)		RE	0,1
Visually conspicuous	(CONVIS)	1 : visually conspicuous 2 : not visually conspicuous 3 : prominent	EN	0,1
Water level effect	(WATLEV)	1 : partly submerged at high water 2 : always dry 3 : always under water / submerged 4 : covers and uncovers 5 : awash 6 : subject to inundation or flooding 7 : floating	EN	0,1
Scale minimum	(SCAMIN)	See clause X.X	IN	0,1

INT 1 Reference: F 2.1, 2.2, 4.1-6.3, 12-15, 23, 30-33.2

8.6.1 Coastline

Natural sections of coastlines, lakeshores and riverbanks should be encoded as **Coastline** (see clause X.X), whereas artificial sections of coastlines, lakeshores, riverbanks, canal banks and basin borders should be encoded as **Shoreline Construction**. The exception to this general rule is when a lake, river, canal, dock or basin is not navigable at the maximum display scale for the ENC data, in which case the boundaries must not be encoded as **Coastline** or **Shoreline Construction**.

These features form the border of the **Land Area** feature.

8.6.2 Artificial coastline (see S-4 – B-313; B-320-322; B-324 and B-329)

If it is required to encode artificial sections of coastlines; or lakeshores, riverbanks, canal banks and basin borders that are navigable at the maximum display scale for the ENC data, this must be done using the feature **Shoreline Construction**.

The largest maximum display scale ENC data should make clear whether any shoreline construction along the coastline is intended for ships to berth alongside or not. In most instances, the associated detail (name or berth number, depths alongside, dolphins, cargo sheds, cranes or railway lines), in addition to the usually distinctive outline of such features as piers and jetties, will be sufficient to show that ships may come alongside. For shoreline constructions not intended to berth alongside (such as breakwaters and seawalls), an indication that ships do not go alongside may be given by encoding the sloping sides (for example the intertidal portion of the structure). If there is a possibility of misinterpretation by the mariner, the danger may be indicated by encoding an **Obstruction** surface feature (see clause X.X) with the seaward edge running parallel to the shoreline construction.

The Figure below represents a shoreline construction such as a mole, including a berthing facility (INT1 - F12), with a relatively flat top (*abcdlmna*), and sloping sides partly above high water (*nmldefgn*) and partly intertidal (*dopqrhgfed*).

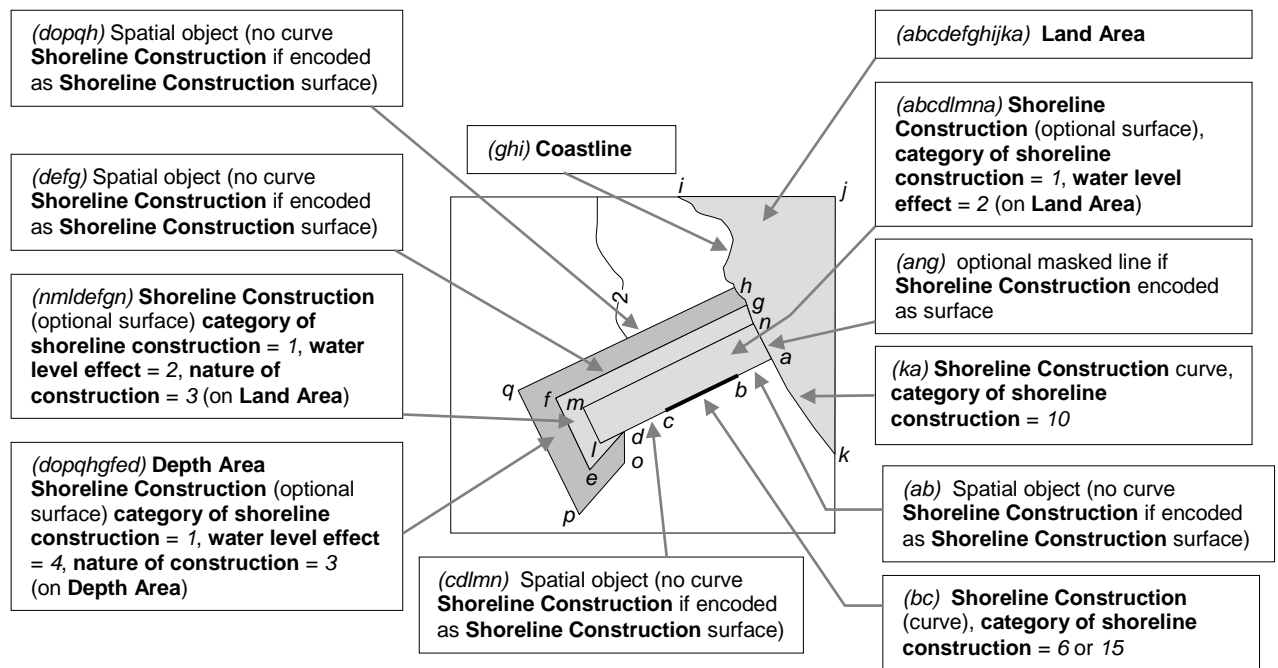

Remarks:

- Each of the three surface parts of the example shoreline construction above may be encoded as separate **Shoreline Construction** features of type surface; the masked curve (*ang*) must be encoded; and, if part of the **Shoreline Construction** boundary has a different characteristic (for example (*bc*) attribute **category of shoreline construction = 6 or 15**), it should be encoded as a separate **Shoreline Construction** feature of type curve. Alternatively, all the boundaries of the components of the shoreline construction may be encoded as **Shoreline Construction** features of type curve.
- In this example, the shoreline construction surface above the high water line must also be covered by a **Land Area** feature of type surface, and the intertidal shoreline construction surface must also be covered by a **Depth Area** feature of type surface with attribute **depth range minimum value = -H** (see clause X.X).
- **Shoreline Construction** features must be broken into their constituent parts where possible, and

categorised using attributes such as **category of shoreline construction** and **water level effect** as indicated on the source.

- If the presence of a feature is only indicated on the source by a textual reference, without a clear symbol (for example 'pier', 'groyne', 'post'), it should be encoded using a **Caution Area** feature (see clause X.X) or an **Information Area** feature (see clause X.X), with the textual reference encoded using an associated instance of the information class **Nautical Information** (see clause X.X), complex attribute **information**. **Caution Area** should be used if the information is considered essential for safe navigation.
- Intertidal or submerged artificial rock walls, such as training walls that are not attached to the shoreline, must be encoded, if required, as **Shoreline Construction** using the appropriate value for **category of shoreline construction**, and **water level effect** = 3 (always under water/submerged) or **water level effect** = 4 (covers and uncovers).

Distinction: Canal bank; causeway; coastline; dry dock; floating dock; gridiron; land area; pontoon.

Feature/Information associations							
Type	Association Name	Association Ends					
		Class	Role	Mult	Class	Role	Mult
Comp	Structure/Equipment	Shoreline Construction	Supported by	0,1	Daymark, Fog Signal, Light Air Obstruction, Light All Around, Light Fog Detector, Light Sector, Physical AIS Aid to Navigation, Radar Transponder Beacon, Retroreflector, Signal Station Traffic, Signal Station Warning	Supports	1,*

8.7 Causeway

IHO Definition: **CAUSEWAY**. A raised way across low or wet ground or water. (IHO Dictionary – S-32).

S-101 Geo Feature: Causeway (CAUSWY)

Primitives: Curve, Surface

Real World

Paper Chart Symbol

ECDIS Symbol

S-101 Attribute	S-57 Acronym	Allowable Encoding Value	Type	Multiplicity
Condition	(CONDTN)	1 : under construction 2 : ruined 3 : under reclamation 5 : planned construction	EN	0,1
Feature name			C	0,*
Display name			(S) BO	0,1
Language		ISO 639-3	(S) TE	0,1
Name	(OBJNAM) (NOBJNM)		(S) TE	1,1
Nature of construction	(NATCON)	1 : masonry 2 : concreted 3 : loose boulders 4 : hard surfaced 5 : unsurfaced 6 : wooden 7 : metal	EN	0,*
Reported date	(SORDAT)	ISO 8601: 2004	TD	0,1
Status	(STATUS)	1 : permanent 7 : temporary 8 : private 12 : illuminated 14 : public	EN	0,*
Water level effect	(WATLEV)	1 : partly submerged at high water 2 : always dry 3 : always under water submerged 4 : covers and uncovers 5 : awash 6 : subject to inundation or flooding	EN	0,1
Scale minimum	(SCAMIN)	See clause X.X	IN	0,1

INT 1 Reference: F 3

8.7.1 Causeways (see S-4 – B-313.3)

A causeway is a raised roadway of solid structure built primarily to provide a route across wet ground or an intertidal area.

If it is required to encode a causeway, it must be done using the feature **Causeway**.

Remarks:

- No remarks.

Distinction: Dam; road.

8.8 Canal

IHO Definition: CANAL. An artificial waterway with no flow, or a controlled flow, used for navigation, or for draining or irrigating land (ditch). (IHO Dictionary – S-32).

S-101 Geo Feature: Canal (CANALS)

Primitives: Curve, Surface

Real World

Paper Chart Symbol

ECDIS Symbol

S-101 Attribute	S-57 Acronym	Allowable Encoding Value	Type	Multiplicity
Category of canal	(CATCAN)	1 : transportation 2 : drainage 3 : irrigation	EN	0,1
Condition	(CONDTN)	1 : under construction 2 : ruined 3 : under reclamation 5 : planned construction	EN	0,1
Fixed date range			C	0,1
Date end	(DATEND)	ISO 8601: 2004	(S) TD	0,1
Date start	(DATSTA)	ISO 8601: 2004	(S) TD	0,1
Horizontal clearance fixed			C	0,1
Horizontal clearance value	(HORCLR)		(S) RE	1,1
Horizontal distance uncertainty	(HORACC)		(S) RE	0,1
Horizontal width	(HORWID)		RE	0,1
Feature name			C	0,*
Display name			(S) BO	0,1
Language		ISO 639-3	(S) TE	0,1
Name	(OBJNAM) (NOBJNM)		(S) TE	1,1
Reported date	(SORDAT)	ISO 8601: 2004	TD	0,1
Status	(STATUS)	1 : permanent 3 : recommended 4 : not in use 5 : periodic/intermittent 6 : reserved 8 : private 14 : public	EN	0,*
Scale minimum	(SCAMIN)	See clause X.X	IN	0,1

INT 1 Reference: F 40

8.8.1 Canals (see S-4 – B-361)

If it is required to encode a non-navigable canal, it must be done using the feature **Canal**.

Remarks:

- If the canal is navigable at the maximum display scale for the ENC data, it must be encoded using the features **Depth Area** or **Dredged Area** (see clause X.X), and the canal banks must be encoded using the features **Coastline** or **Shoreline Construction**. The canal must not be encoded as a **Canal** feature. If it is

required to encode the name of the canal, it must be done using a **Sea Area/Named Water Area** feature, with attribute **category of sea area = 51** (canal).

- Where the canal is navigable at the maximum display scale for the ENC data, special consideration should be given to encoding features specific to the canal such as minimum depths within the navigable area; overhead clearances; distances along the canal; and locks and lock gates (and any associated traffic signals).
- If it is required to encode a canal that is not navigable at the maximum display scale for the ENC data, it must be done using **Canal**, covered by a **Land Area** feature. The name of the canal should be encoded using the complex attribute **feature name** on the **Canal** feature.

Distinction: River; lake; tideway.

8.9 Distance mark

IHO Definition: **DISTANCE MARK.** A distance mark indicates the distance measured from an origin and consists of either a solid visible structure or a distinct location without special installation. Usually found on canals. (S-57 Edition 3.1, Appendix A – Chapter 1, Page 1.55, November 2000).

S-101 Geo Feature: Distance mark (DISMAR)

Primitives: Point

<i>Real World</i>	<i>Paper Chart Symbol</i>	<i>ECDIS Symbol</i>		
S-101 Attribute	S-57 Acronym	Allowable Encoding Value	Type	Multiplicity
Category of distance mark	(CATDIS)	1 : distance mark not physically installed 2 : visible mark, pole 3 : visible mark, board 4 : visible mark, unknown shape	EN	0,1
Feature name			C	0,*
Display name			(S) BO	0,1
Language		ISO 639-3	(S) TE	0,1
Name	(OBJNAM) (NOBJNM)		(S) TE	1,1
Fixed date range			C	0,1
Date end	(DATEND)	ISO 8601: 2004	(S) TD	0,1
Date start	(DATSTA)	ISO 8601: 2004	(S) TD	0,1
Measured distance value	(INFORM) (NINFOM)		C	1,1
Distance unit of measurement		1 : metres 2 : yards 3 : kilometres 4 : statute miles 5: nautical miles	(S) EN	1,1
Reference location			(S) TE	0,1
Waterway distance			(S) RE	1,1
Scale minimum	(SCAMIN)	See clause X.X	IN	0,1

INT 1 Reference: B 25.1-2

8.9.1 Distance marks (see S-4 – B-307 and B-361.3)

Marks which indicate distances along a channel in nautical miles, kilometres or some other unit of measure are considered to be useful on the largest maximum display scale ENC data.

If it is required to encode a distance mark, it must be done using the feature **Distance Mark**.

Remarks:

- The origin from which the distance has been measured is indicated using the sub-attribute **reference location**.
- For encoding a measured distance between two transits of marks established on the shore, see clause X.X.

Distinction: Beacon special purpose.

8.10 Gate

IHO Definition: **GATE.** A structure that may be swung, drawn, or lowered to block an entrance or passageway on a watercourse. (Defence Geospatial Information Working Group; Feature Data Dictionary Register, 2012).

S-101 Geo Feature: Gate (GATCON)

Primitives: Point, Curve, Surface

Real World

Paper Chart Symbol

ECDIS Symbol

S-101 Attribute	S-57 Acronym	Allowable Encoding Value	Type	Multiplicity
Category of gate	(CATGAT)	2 : flood barrage gate 3 : caisson 4 : lock gate 5 : dyke gate 6 : sluice	EN	0,1
Condition	(CONDTN)	1 : under construction 2 : ruined 5 : planned construction	EN	0,1
Depth range minimum value	(DRVAL1)		RE	0,1
Feature name			C	0,*
Display name			(S) BO	0,1
Language		ISO 639-3	(S) TE	0,1
Name	(OBJNAM) (NOBJNM)		(S) TE	1,1
Horizontal clearance open			C	0,1
Horizontal clearance value	(HORCLR)		(S) RE	1,1
Horizontal distance uncertainty	(HORACC)		(S) RE	0,1
Nature of construction	(NATCON)	1 : masonry 2 : concreted 6 : wooden 7 : metal	EN	0,*
Quality of vertical measurement	(QUASOU)	2 : depth or least depth unknown 3 : doubtful sounding 4 : unreliable sounding 6 : least depth known 7 : least depth unknown, safe clearance at value shown	EN	0,*
Reported date	(SORDAT)	ISO 8601: 2004	TD	0,1
Status	(STATUS)	1 : permanent 4 : not in use 6 : reserved 16 : watched 17 : un-watched	EN	0,*
Vertical clearance open			C	0,1
Clearance value vertical	(VERCOP)		(S) RE	1,1

Vertical uncertainty	(VERACC)		(S) C	0,1
Uncertainty fixed			(S) RE	1,1
Uncertainty variable			(S) RE	0.1
Vertical datum	(VERDAT)	3 : Mean sea level 16 : Mean high water 17 : Mean high water springs 18 : High water 19 : Approximate mean sea level 20 : High water springs 21 : Mean higher high water 24 : Local datum 25 : International great lakes datum 1985 26 : Mean water level 28 : Higher high water large tide 29 : Nearly highest high water 30 : Highest astronomical tide (HAT)	EN	0,1
Vertical uncertainty	(SOUACC)		C	0,1
Uncertainty fixed			(S) RE	1,1
Uncertainty variable			(S) RE	0.1
Scale minimum	(SCAMIN)	See clause X.X	IN	0,1
<p><u>INT 1 Reference:</u> F 27, 41.1-2, 42-43</p> <p>8.10.1 Gates (see S-4 – B-326.5-7)</p> <p>If it is required to encode a gate that controls the flow of water, it must be done using the feature Gate. Gates should always be encoded in the closed (to the sea) position.</p> <p><u>Remarks:</u></p> <ul style="list-style-type: none"> • Gate of type surface must also be covered by a Depth Area, Unsurveyed Area or Land Area feature. • The attribute depth range minimum value is used to encode the minimum depth over the sill, where known. <p><u>Distinction:</u> Dry dock; floating dock.</p>				

8.11 Dam

<u>IHO Definition:</u> DAM. A barrier to check or confine anything in motion; particularly one constructed to hold back water and raise its level to form a reservoir, or to prevent flooding. (IHO Dictionary – S-32).				
S-101 Geo Feature: Dam (DAMCON)				
Primitives: Curve, Surface				
<i>Real World</i>		<i>Paper Chart Symbol</i>		<i>ECDIS Symbol</i>
S-101 Attribute	S-57 Acronym	Allowable Encoding Value	Type	Multiplicity
Category of dam	(CATDAM)	1 : weir 2 : dam 3 : flood barrage	EN	0,1
Colour	(COLOUR)	1 : white 2 : black 3 : red 4 : green 5 : blue 6 : yellow 7 : grey 8 : brown 9 : amber 10 : violet 11 : orange 12 : magenta 13 : pink	EN	0,* (ordered)
Colour pattern	(COLPAT)	1 : horizontal stripes 2 : vertical stripes 3 : diagonal stripes 4 : squared 5 : stripes (direction unknown) 6 : border stripe	EN	0,1
Condition	(CONDTN)	1 : under construction 2 : ruined 3 : under reclamation 5 : planned construction	EN	0,1
Feature name			C	0,*
Display name			(S) BO	0,1
Language		ISO 639-3	(S) TE	0,1
Name	(OBJNAM) (NOBJNM)		(S) TE	1,1
Fixed date range			C	0,1
Date end	(DATEND)	ISO 8601: 2004	(S) TD	0,1
Date start	(DATSTA)	ISO 8601: 2004	(S) TD	0,1
Height	(HEIGHT)		RE	0,1
Nature of construction	(NATCON)	1 : masonry 2 : concreted 3 : loose boulders 6 : wooden	EN	0,*

		7 : metal		
Radar conspicuous	(CONRAD)		BO	0,1
Reported date	(SORDAT)	ISO 8601: 2004	TD	0,1
Status	(STATUS)	1 : permanent 2 : occasional 6 : reserved 7 : temporary 8 : private 14 : public 28 : buoyed	EN	0,*
Vertical length	(VERLEN)		RE	0,1
Visually conspicuous	(CONVIS)	1 : visually conspicuous 2 : not visually conspicuous 3 : prominent	EN	0,1
Water level effect	(WATLEV)	1 : partly submerged at high water 2 : always dry 3 : always under water / submerged 6 : subject to inundation or flooding	EN	0,1
Scale minimum	(SCAMIN)	See clause X.X	IN	0,1

INT 1 Reference: F 43, 44

8.11.1 Dams (see S-4 –B-364.2)

If it is required to encode a dam, weir or flood barrage, it must be done using the feature **Dam**.

- When a **Dam** feature is of type surface, it must be covered by a **Land Area** feature.
- The geometry of the dam includes any gates. Gates should be encoded as separate **Gate** features.
- If it is required to encode a dam whose seaward edge is coincident with the coastline, it must be done using **Dam**, with a **Shoreline Construction** feature of type curve along its seaward edge, with no value populated for the attribute **category of shoreline construction**.
- If it is required to encode a submerged weir, it should be done using an **Dam** feature, with attribute **water level effect** = 3 (always under water/submerged).

8.11.2 Flood barrages (see S-4 –B-326.7)

If it is required to encode the fixed part of a flood barrage, and the flood barrage is inside an area which is navigable at compilation scale, it must be done using a **Dam** feature, with attribute **category of dam** = 3 (flood barrage), and must be covered by a **Land Area** feature. If it is required to encode the opening part of the flood barrage, it must be done using a **Gate** feature, with attribute **category of gate** = 2 (flood barrage gate), and must be covered by a **Depth Area** feature.

When an encoded flood barrage is inside an area that is not navigable at the maximum display scale for the ENC data, the gates need not be encoded. In this case, the **Dam** feature must go all the way across the river or lake.

Distinction: Causeway; dyke; oil barrier; road.

8.12 Crane

IHO Definition: CRANE. A machine for lifting, shifting and lowering objects or materials by means of a swinging boom or with a lifting apparatus supported on an overhead track. (Defence Geospatial Information Working Group; Feature Data Dictionary Register, 2010).				
S-101 Geo Feature: Crane (CRANES)				
Primitives: Point, Curve, Surface				
<i>Real World</i>		<i>Paper Chart Symbol</i>		<i>ECDIS Symbol</i>
S-101 Attribute	S-57 Acronym	Allowable Encoding Value	Type	Multiplicity
Category of crane	(CATCRN)	2 : container crane/gantry 3 : sheerlegs 4 : travelling crane 5 : A-frame 6 : goliath crane	EN	0,1
Colour	(COLOUR)	1 : white 2 : black 3 : red 4 : green 5 : blue 6 : yellow 7 : grey 8 : brown 9 : amber 10 : violet 11 : orange 12 : magenta 13 : pink	EN	0,* (ordered)
Colour pattern	(COLPAT)	1 : horizontal stripes 2 : vertical stripes 3 : diagonal stripes 4 : squared 5 : stripes (direction unknown) 6 : border stripe	EN	0,1
Condition	(CONDTN)	1 : under construction 2 : ruined 5 : planned construction	EN	0,1
Feature name			C	0,*
Display name			(S) BO	0,1
Language		ISO 639-3	(S) TE	0,1
Name	(OBJNAM) (NOBJNM)		(S) TE	1,1
Height	(HEIGHT)		RE	0,1
Lifting capacity	(LIFCAP)		RE	0,1
Orientation			C	0,1
Orientation uncertainty			(S) RE	0,1
Orientation value	(ORIENT)		(S) RE	1,1

Radar conspicuous	(CONRAD)		BO	0,1
Radius	(RADIUS)		RE	0,1
Reported date	(SORDAT)	ISO 8601: 2004	TD	0,1
Status	(STATUS)	1 : permanent 4 : not in use 6 : reserved 12 : illuminated	EN	0,*
Vertical clearance fixed			C	0,1
Vertical clearance value	(VERCLR)		(S) RE	1,1
Vertical uncertainty	(VERACC)		(S) C	0,1
Uncertainty fixed			(S) RE	1,1
Uncertainty variable			(S) RE	0.1
Vertical datum	(VERDAT)	3 : Mean sea level 16 : Mean high water 17 : Mean high water springs 18 : High water 19 : Approximate mean sea level 20 : High water springs 21 : Mean higher high water 24 : Local datum 25 : International great lakes datum 1985 26 : Mean water level 28 : Higher high water large tide 29 : Nearly highest high water 30 : Highest astronomical tide (HAT)	EN	0,1
Vertical length	(VERLEN)		RE	0,1
Visually conspicuous	(CONVIS)	1 : visually conspicuous 2 : not visually conspicuous 3 : prominent	EN	0,1
Scale minimum	(SCAMIN)	See clause X.X	IN	0,1
In the water			BO	0,1

INT 1 Reference: F 53.1-3

8.12.1 Cranes (see S-4 – B-328.3)

If it is required to encode a crane, it must be done using the feature **Crane**.

Remarks:

- The purpose of charting these features is primarily to assist the mariner in identifying particular berths, etc.
- The complex attribute **orientation** is used, where required, to encode the angular distance from true north to the axis of the crane's jib (generally perpendicular to the wharf).
- The position of a sheerleg or a travelling crane is defined as its resting position. If it is required to encode the track, it must be done using the feature **Railway** (see clause X.X).
- Where fitted, lights should be encoded as described in clauses X.X to X.X, with the **Crane** being used as the structure feature for the relevant light equipment feature(s) (see clause X.X).
- For cranes located in navigable water, the Boolean attribute **in the water** must be set to *True* to indicate that the feature is to be included in the ECDIS Base Display. Where such structures are located in the water it is not required to encode any supporting structures (for example piles, stilts).

Distinction: Conveyor.

Feature/Information associations							
Type	Association Name	Association Ends					
		Class	Role	Mult	Class	Role	Mult
Comp	Structure/Equipment	Crane	Supported by	0,1	Daymark, Fog Signal, Light Air Obstruction, Light All Around, Light Fog Detector, Light Sector, Physical AIS Aid to Navigation, Radar Transponder Beacon, Retroreflector, Signal Station Traffic, Signal Station Warning	Supports	1,*

8.13 Berth

<u>IHO Definition:</u> BERTH. Place in which a ship is moored at wharf. (IHO Dictionary – S-32).				
S-101 Geo Feature: Berth (BERTHS)				
Primitives: Point, Curve, Surface				
<i>Real World</i>		<i>Paper Chart Symbol</i>		<i>ECDIS Symbol</i>
S-101 Attribute	S-57 Acronym	Allowable Encoding Value	Type	Multiplicity
Depth range minimum value	(DRVAL1)		RE	0,1
Feature name			C	1,*
Display name			(S) BO	0,1
Language		ISO 639-3	(S) TE	0,1
Name	(OBJNAM) (NOBJNM)		(S) TE	1,1
Fixed date range			C	0,1
Date end	(DATEND)	ISO 8601: 2004	(S) TD	0,1
Date start	(DATSTA)	ISO 8601: 2004	(S) TD	0,1
Horizontal clearance length			RE	0,1
Horizontal clearance width			RE	0,1
Maximum permitted draught	(INFORM) (NINFOM)		RE	0,1
Periodic date range			C	0,*
Date end	(PEREND)	ISO 8601: 2004	(S) TD	1,1
Date start	(PERSTA)	ISO 8601: 2004	(S) TD	1,1
Quality of vertical measurement	(QUASOU)	1 : depth known 2 : depth or least depth unknown	EN	0,*
Status	(STATUS)	1 : permanent 2 : occasional 5 : periodic/intermittent 7 : temporary 9 : mandatory 12 : illuminated	EN	0,*
Vertical uncertainty	(SOUACC)		C	0,1
Uncertainty fixed			(S) RE	1,1
Uncertainty variable			(S) RE	0,1
Scale minimum	(SCAMIN)	See clause X.X	IN	0,1
<u>INT 1 Reference:</u> F 12, 19				
8.13.1 Berths (see S-4 – B-321; B-321.6-8)				
Numbered, named or lettered berth information must be encoded on at least the largest maximum display scale ENC data, in order to assist the mariner in berthing activities within ports and harbours.				

If it is required to encode a berth, it must be done using the feature **Berth**.

Remarks:

- The berth encodes the named place where a vessel can be moored adjacent to a shoreline construction. The shoreline construction itself should be encoded using the feature **Shoreline Construction** (see clause X.X).
- The attributes **horizontal clearance length** and **horizontal clearance width** are used to encode the regulatory length and width of the navigable part of the berth as declared by a competent authority, where known.
- The mandatory complex attribute **feature name** is used to encode the name or number of the berth. The attributes **depth range minimum value** and **maximum permitted draught** are used to encode the shoalest physical depth and maximum draught permitted at the berth respectively, where known.
- Terminal facilities (for example container, tanker, ferry) must be encoded, where required, using the feature **Harbour Facility** (see clause X.X).
- Landing places for boats should be encoded as small craft facilities (see clause X.X).
- For encoding anchor berths, see clause X.X.

Distinction: Anchor berth; dock area; mooring/warping facility; shoreline construction.

8.14 Mooring/warping facility

IHO Definition: **MOORING/WARPING FACILITY**. The equipment or structure used to secure a vessel. (Adapted from IHO Dictionary – S-32).

S-101 Geo Feature: Mooring/warping facility (MORFAC)

Primitives: Point, Curve, Surface

Real World

Paper Chart Symbol

ECDIS Symbol

S-101 Attribute	S-57 Acronym	Allowable Encoding Value	Type	Multiplicity
Buoy shape	(BOYSHP)	1 : conical (nun, ogival) 2 : can (cylindrical) 3 : spherical 4 : pillar 5 : spar (spindle) 6 : barrel (tun) 7 : superbuoy 8 : ice buoy	EN	0,1
Category of mooring/warping facility	(CATMOR)	1 : dolphin 2 : deviation dolphin 3 : bollard 4 : tie-up wall 5 : post or pile 6 : chain/wire/cable 7 : mooring buoy	EN	1,1
Colour	(COLOUR)	1 : white 2 : black 3 : red 4 : green 5 : blue 6 : yellow 7 : grey 8 : brown 9 : amber 10 : violet 11 : orange 12 : magenta 13 : pink	EN	0,* (ordered)
Colour pattern	(COLPAT)	1 : horizontal stripes 2 : vertical stripes 3 : diagonal stripes 4 : squared 5 : stripes (direction unknown) 6 : border stripe	EN	0,1
Condition	(CONDTN)	1 : under construction 2 : ruined 5 : planned construction	EN	0,1
Elevation	(ELEVAT)		RE	0,1
Feature name			C	0,*
Display name			(S) BO	0,1
Language		ISO 639-3	(S) TE	0,1

Name	(OBJNAM) (NOBJNM)		(S) TE	1,1
Fixed date range			C	0,1
Date end	(DATEND)	ISO 8601: 2004	(S) TD	0,1
Date start	(DATSTA)	ISO 8601: 2004	(S) TD	0,1
Height	(HEIGHT)		RE	0,1
Nature of construction	(NATCON)	1 : masonry 2 : concreted 6 : wooden 7 : metal	EN	0,*
Periodic date range			C	0,*
Date end	(PEREND)	ISO 8601: 2004	(S) TD	1,1
Date start	(PERSTA)	ISO 8601: 2004	(S) TD	1,1
Quality of vertical measurement	(QUASOU)	2 : depth or least depth unknown 3 : doubtful sounding 4 : unreliable sounding 6 : least depth known 7 : least depth unknown, safe clearance at value shown	EN	0,*
Radar conspicuous	(CONRAD)		BO	0,1
Reported date	(SORDAT)	ISO 8601: 2004	TD	0,1
Status	(STATUS)	1 : permanent 2 : occasional 3 : recommended 4 : not in use 5 : periodic/intermittent 6 : reserved 7 : temporary 8 : private 12 : illuminated 14 : public 18 : existence doubtful	EN	0,*
Vertical length	(VERLEN)		RE	0,1
Visually conspicuous	(CONVIS)	1 : visually conspicuous 2 : not visually conspicuous 3 : prominent	EN	0,1
Water level effect	(WATLEV)	1 : partly submerged at high water 2 : always dry 3 : always under water / submerged 4 : covers and uncovers 5 : awash 6 : subject to inundation or flooding	EN	0,1
Scale minimum	(SCAMIN)	See clause X.X	IN	0,1

INT 1 Reference: F 20-22; Q 40-43

8.14.1 Mooring / warping facilities (see S-4 – B-327.1-4; B-431.5-6)

If it is required to encode a mooring/warping facility, it must be done using the feature **Mooring/Warping Facility**.

Remarks:

- If it is required to encode a pile or post that is used as a mooring post, it must be done using **Mooring/Warping Facility**, with attribute **category of mooring/warping facility** = 5 (pile or post). If the pile or post is not used as a mooring post, see clause X.X.
- Stumps of mooring posts dangerous to navigation must be encoded using the feature **Obstruction**, with attribute **category of obstruction** = 1 (snag/stump). If such stumps are not dangerous to navigation, they must be encoded using **Mooring/Warping Facility**, with attributes **category of mooring/warping facility** = 5 (pile or post) and **condition** = 2 (ruined).
- A **Mooring/Warping Facility** feature of type surface, with attribute **water level effect** = 1, 2 or 6 must also be covered by a **Land Area** feature.

8.14.1.1 Mooring buoys (see S-4 – B-431.5)

If it is required to encode a mooring buoy, it must be done using a **Mooring/Warping Facility** feature, with attribute **category of mooring/warping facility** = 7 (mooring buoy). The attribute **buoy shape** must only be populated for a mooring/warping facility when encoding a mooring buoy.

8.14.1.2 Mooring trots (see S-4 – B-431.6)

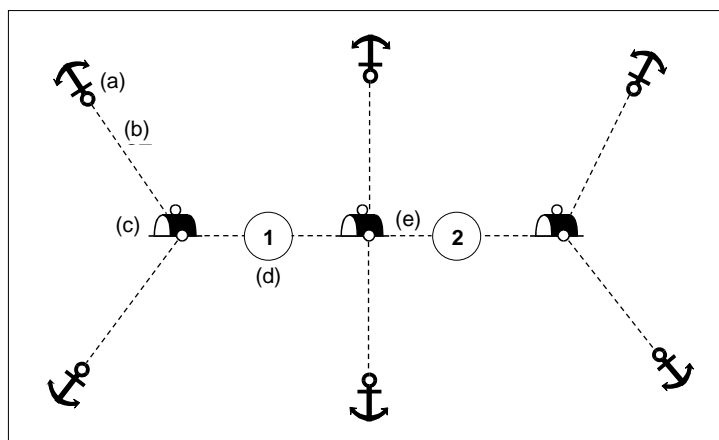

A complete mooring trot is composed of ground tackle, mooring cables, buoys and mooring berths on junction cables. The following remarks refer to the annotations in the Figure above:

- (a) Ground tackle should be encoded using **Obstruction** features (see clause X.X), with attribute **category of obstruction** = 9 (ground tackle).
- (b) Mooring cables should be encoded using **Cable Submarine** features (see clause X.X), with attribute **category of cable** = 6 (mooring cable/chain).
- (c) Buoys should be encoded using **Mooring/Warping Facility** features, with attribute **category of mooring/warping facility** = 7 (mooring buoy).
- (d) Mooring berths should be encoded using **Berth** features.
- (e) Junction cables should be encoded using **Mooring/Warping Facility** features, with attribute **category of mooring/warping facility** = 6 (chain/wire/cable).

All these features should be aggregated using the named aggregation feature “Mooring Trot” (see clause X.X), with the name of the mooring trot being populated using the complex attribute **feature name** for the named aggregation.

Distinction: Beacon special purpose/general; buoy special purpose/general; pile.

Feature/Information associations							
Type	Association Name	Association Ends					
		Class	Role	Mult	Class	Role	Mult
Comp	Structure/Equipment	Mooring/Warping Facility	Supported by	0,1	Daymark, Fog Signal, Light Air Obstruction, Light All Around, Light Fog Detector, Light Sectored,	Supports	1,*

					Physical AIS Aid to Navigation, Radar Transponder Beacon, Retroreflector, Signal Station Traffic, Signal Station Warning		
Aggr	Range System Aggregation	Mooring/Warping Facility	Consists of	1,*	Range System	Component of	0,1

8.15 Dry dock

IHO Definition: DRY DOCK. An artificial basin fitted with a gate or caisson, into which vessels can be floated and the water pumped out to expose the vessel's bottom. Also called graving dock. (IHO Dictionary – S-32).

S-101 Geo Feature: Dry dock (DRYDOC)

Primitives: Surface

Real World

Paper Chart Symbol

ECDIS Symbol

S-101 Attribute	S-57 Acronym	Allowable Encoding Value	Type	Multiplicity
Condition	(CONDTN)	1 : under construction 2 : ruined 3 : under reclamation 5 : planned construction	EN	0,1
Depth range minimum value	(DRVAL1)		RE	0,1
Elevation	(ELEVAT)		RE	0,1
Feature name			C	0,*
Display name			(S) BO	0,1
Language		ISO 639-3	(S) TE	0,1
Name	(OBJNAM) (NOBJNM)		(S) TE	1,1
Horizontal clearance length			RE	0,1
Horizontal clearance width			RE	0,1
Horizontal length	(HORLEN)		RE	0,1
Horizontal width	(HORWID)		RE	0,1
Maximum permitted draught	(INFORM) (NINFOM)		RE	0,1
Quality of vertical measurement	(QUASOU)	2 : depth or least depth unknown 3 : doubtful sounding 4 : unreliable sounding 6 : least depth known 7 : least depth unknown, safe clearance at value shown 8 : value reported (not surveyed) 9 : value reported (not confirmed)	EN	0,*
Reported date	(SORDAT)	ISO 8601: 2004	TD	0,1
Status	(STATUS)	1 : permanent 4 : not in use 6 : reserved 8 : private 12 : illuminated 14 : public	EN	0,*
Vertical uncertainty	(SOUACC)		C	0,1
Uncertainty fixed			(S) RE	1,1

Uncertainty variable			(S) RE	0.1
Scale minimum	(SCAMIN)	See clause X.X	IN	0,1
<p><u>INT 1 Reference:</u> F 25</p> <p>8.15.1 Dry docks (see S-4 – B-326.1)</p> <p>A dry dock (or graving dock) is an artificial basin into which a ship can be floated for cleaning and repairs. The entrance can be closed by gate or caisson and the water pumped out to expose the vessel's bottom.</p> <p>If it is required to encode a dry dock, it must be done using the feature Dry Dock.</p> <p><u>Remarks:</u></p> <ul style="list-style-type: none"> • A dry dock must also be covered by a Land Area feature. The boundary of a dry dock must not be encoded as a separate feature (Coastline or Shoreline Construction), except for the gate feature (Gate), which may be encoded. • The attributes horizontal clearance length and horizontal clearance width are used to encode the regulatory length and width of the navigable part of the dry dock when the gate is open as declared by a competent authority, where known. If required, the minimum physical length and width of the dry dock itself must be populated using the attributes horizontal length and horizontal width. • The attributes depth range minimum value and maximum permitted draught are used to encode the shoalest physical depth in the dock when the gate is open and maximum draught permitted in the dock respectively, where known. <p><u>Distinction:</u> Dock area; floating dock; gate; shoreline construction.</p>				

8.16 Floating dock

IHO Definition: FLOATING DOCK. A form of dry dock consisting of a floating structure of one or more sections which can be partly submerged by controlled flooding to receive a vessel, then raised by pumping out the water so that the vessel's bottom can be exposed. (IHO Dictionary – S-32).

S-101 Geo Feature: Floating dock (FLODOC)

Primitives: Point, Curve, Surface

Real World

Paper Chart Symbol

ECDIS Symbol

S-101 Attribute	S-57 Acronym	Allowable Encoding Value	Type	Multiplicity
Colour	(COLOUR)	1 : white 2 : black 3 : red 4 : green 5 : blue 6 : yellow 7 : grey 8 : brown 9 : amber 10 : violet 11 : orange 12 : magenta 13 : pink	EN	0,* (ordered)
Colour pattern	(COLPAT)	1 : horizontal stripes 2 : vertical stripes 3 : diagonal stripes 4 : squared 5 : stripes (direction unknown) 6 : border stripe	EN	0,1
Condition	(CONDTN)	1 : under construction 2 : ruined 5 : planned construction	EN	0,1
Depth range minimum value	(DRVAL1)		RE	0,1
Feature name			C	0,*
Display name			(S) BO	0,1
Language		ISO 639-3	(S) TE	0,1
Name	(OBJNAM) (NOBJNM)		(S) TE	1,1
Fixed date range			C	0,1
Date end	(DATEND)	ISO 8601: 2004	(S) TD	0,1
Date start	(DATSTA)	ISO 8601: 2004	(S) TD	0,1
Horizontal clearance length			RE	0,1
Horizontal clearance width			RE	0,1
Horizontal length	(HORLEN)		RE	0,1
Horizontal width	(HORWID)		RE	0,1
Lifting capacity	(LIFCAP)		RE	0,1

Maximum permitted draught	(INFORM) (NINFOM)		RE	0,1
Radar conspicuous	(CONRAD)		BO	0,1
Reported date	(SORDAT)	ISO 8601: 2004	TD	0,1
Status	(STATUS)	1 : permanent 4 : not in use 6 : reserved 7 : temporary 8 : private 12 : illuminated	EN	0,*
Vertical length	(VERLEN)		RE	0,1
Visually conspicuous	(CONVIS)	1 : visually conspicuous 2 : not visually conspicuous 3 : prominent	EN	0,1
Scale minimum	(SCAMIN)	See clause X.X	IN	0,1

INT 1 Reference: F 26

8.16.1 Floating docks (see S-4 – B-326.2)

If it is required to encode a floating dock, it must be done using the feature **Floating Dock**.

Remarks:

- A **Floating Dock** feature must also be covered by **Depth Area**, **Dredged Area** or **Unsurveyed Area** features. The boundary of a **Floating Dock** feature of type surface must not be encoded as a separate feature (**Coastline** or **Shoreline Construction**).
- The attributes **horizontal clearance length** and **horizontal clearance width** are used to encode the regulatory length and width of the navigable part of the floating dock as declared by a competent authority, where known. If required, the minimum physical length and width of the dry dock itself must be populated using the attributes **horizontal length** and **horizontal width**.
- The attribute **depth range minimum value** is used to encode the shoalest depth of the dock when flooded, and the attribute **maximum permitted draught** is used to encode the maximum draught permitted in the dock, where known.

Distinction: Dock area; dry dock.

Feature/Information associations							
Type	Association Name	Association Ends					
		Class	Role	Mult	Class	Role	Mult
Comp	Structure/Equipment	Floating Dock	Supported by	0,1	Daymark, Fog Signal, Light Air Obstruction, Light All Around, Light Fog Detector, Light Sectored, Physical AIS Aid to Navigation, Radar Transponder Beacon, Retroreflector, Signal Station Traffic, Signal Station Warning	Supports	1,*

8.17 Pontoon

IHO Definition: **PONTOON**. A floating structure, usually rectangular in shape which serves as landing, pier head, bridge support, etc. (Adapted from IHO Dictionary – S-32).

S-101 Geo Feature: Pontoon (PONTON)

Primitives: Point, Curve, Surface

Real World

Paper Chart Symbol

ECDIS Symbol

S-101 Attribute	S-57 Acronym	Allowable Encoding Value	Type	Multiplicity
Condition	(CONDTN)	1 : under construction 2 : ruined 5 : planned construction	EN	0,1
Feature name			C	0,*
Display name			(S) BO	0,1
Language		ISO 639-3	(S) TE	0,1
Name	(OBJNAM) (NOBJNM)		(S) TE	1,1
Fixed date range			C	0,1
Date end	(DATEND)	ISO 8601: 2004	(S) TD	0,1
Date start	(DATSTA)	ISO 8601: 2004	(S) TD	0,1
Periodic date range			C	0,*
Date end	(PEREND)	ISO 8601: 2004	(S) TD	1,1
Date start	(PERSTA)	ISO 8601: 2004	(S) TD	1,1
Radar conspicuous	(CONRAD)		BO	0,1
Reported date	(SORDAT)	ISO 8601: 2004	TD	0,1
Status	(STATUS)	1 : permanent 2 : occasional 4 : not in use 5 : periodic/intermittent 6 : reserved 7 : temporary 8 : private 12 : illuminated 14 : public	EN	0,*
Vertical length	(VERLEN)		RE	0,1
Visually conspicuous	(CONVIS)	1 : visually conspicuous 2 : not visually conspicuous 3 : prominent	EN	0,1
Scale minimum	(SCAMIN)	See clause X.X	IN	0,1

INT 1 Reference: F 16

8.17.1 Pontoons (see S-4 – B-324.3)

If it is required to encode a pontoon, it must be done using the feature **Pontoon**.

Remarks:

- A **Pontoon** feature must also be covered by **Depth Area**, **Dredged Area** or **Unsurveyed Area** features. A

Pontoon feature of type surface must not be bound by curve features **Coastline** or **Shoreline Construction**, unless the edge associated with the curve feature is also the boundary of a **Land Area** feature of type surface.

Distinction: Bridge; mooring/warping facility; shoreline construction.

Feature/Information associations							
Type	Association Name	Association Ends					
		Class	Role	Mult	Class	Role	Mult
Comp	Structure/Equipment	Pontoon	Supported by	0,1	Daymark, Fog Signal, Light Air Obstruction, Light All Around, Light Fog Detector, Light Sectored, Physical AIS Aid to Navigation, Radar Transponder Beacon, Retroreflector, Signal Station Traffic, Signal Station Warning	Supports	1,*

8.18 Dock area

IHO Definition: DOCK AREA. An artificially enclosed area within which ships may moor and which may have gates to regulate water level. (S-57 Edition 3.1, Appendix A – Chapter 1, Page 1.56, November 2000).

S-101 Geo Feature: Dock area (DOCARE)

Primitives: Surface

Real World

Paper Chart Symbol

ECDIS Symbol

S-101 Attribute	S-57 Acronym	Allowable Encoding Value	Type	Multiplicity
Category of dock	(CATDOC)	1: tidal 2: non-tidal (wet dock)	EN	0,1
Condition	(CONDTN)	1 : under construction 2 : ruined 3 : under reclamation 5 : planned construction	EN	0,1
Feature name			C	0,*
Display name			(S) BO	0,1
Language		ISO 639-3	(S) TE	0,1
Name	(OBJNAM) (NOBJNM)		(S) TE	1,1
Fixed date range			C	0,1
Date end	(DATEND)	ISO 8601: 2004	(S) TD	0,1
Date start	(DATSTA)	ISO 8601: 2004	(S) TD	0,1
Horizontal clearance fixed			C	0,1
Horizontal clearance value	(HORCLR)		(S) RE	1,1
Horizontal distance uncertainty	(HORACC)		(S) RE	0,1
Horizontal clearance length			RE	0,1
Horizontal clearance width			RE	0,1
Maximum permitted draught			RE	0,1
Reported date	(SORDAT)	ISO 8601: 2004	TD	0,1
Status	(STATUS)	1 : permanent 4 : not in use 6 : reserved 8 : private 14 : public	EN	0,*

INT 1 Reference: F 27, 28

8.18.1 Tidal and non-tidal basins (see S-4 – B-326.3-4)

If it is required to encode a non-navigable dock area, it must be done using the feature **Dock Area**.

Remarks:

- If the dock is navigable at the maximum display scale of the ENC data, it must be encoded using the features **Depth Area**, **Dredged Area** or **Unsurveyed Area** (see clause X.X), and the geo features making up the dock limits must be encoded using appropriate features such as **Coastline**, **Shoreline Construction** or **Gate**. The dock must not be encoded as **Dock Area**. If it is required to encode the name of the dock, it

must be done using the feature **Sea Area/Named Water Area**.

- If it is required to encode a dock which is not navigable at the maximum display scale of the ENC data, it must be done using the feature **Dock Area**. The name of the dock should be encoded using the complex attribute **feature name** on the **Dock Area**. The boundary of a dock must not be encoded as a separate feature (for example **Coastline, Shoreline Construction**), except for the gate feature (**Gate**) for a non-tidal dock, which may be encoded.
- **Dock Area** are part of the Skin of the Earth.
- The complex attribute **horizontal clearance fixed** is used to encode the size of the entrance to the dock area, where required.
- The attributes **horizontal clearance length** and **horizontal clearance width** are used to encode the regulatory length and width of the navigable part of the dock area as declared by a competent authority, where known.
- In a non-tidal basin, depths may refer to a sounding datum different from that in open waters. If this area is navigable at the maximum display scale of the ENC data, the value of this datum must be encoded using the meta feature **Sounding Datum**, with attribute **vertical datum** = 24 (local datum), co-incident with the area covered by the dock.
- In reality, smaller dock areas may be included in major dock areas, with different names or characteristics. To encode this fact, dock areas (**Dock Area**) and/or sea areas (**Sea Area/Named Water Area**) may overlap. In cases where **Dock Area** and **Sea Area/Named Water Area** overlap, the **Dock Area** must also be covered by **Unsurveyed Area** (not **Land Area**).

Distinction: Berth; cargo transshipment area; dry dock; floating dock; gate; harbour area (administrative); harbour facility.

8.19 Gridiron

IHO Definition: GRIDIRON. A structure in the intertidal zone serving as a support for vessels at low stages of the tide to permit work on the exposed portion of the vessel's hull. Also called careening grid. (IHO Dictionary – S-32).

S-101 Geo Feature: Gridiron (GRIDRN)

Primitives: Surface

Real World

Paper Chart Symbol

ECDIS Symbol

S-101 Attribute	S-57 Acronym	Allowable Encoding Value	Type	Multiplicity
Feature name			C	0,*
Display name			(S) BO	0,1
Language		ISO 639-3	(S) TE	0,1
Name	(OBJNAM) (NOBJNM)		(S) TE	1,1
Horizontal length	(HORLEN)		RE	0,1
Horizontal width	(HORWID)		RE	0,1
Nature of construction	(NATCON)	1 : masonry 2 : concreted 6 : wooden 7 : metal 11 : latticed	EN	0,*
Status	(STATUS)	1 : permanent 4 : not in use 6 : reserved 8 : private 14 : public 28 : buoyed	EN	0,*
Vertical length	(VERLEN)		RE	0,1
Water level effect	(WATLEV)	1 : partly submerged at high water 4 : covers and uncovers 5 : awash	EN	0,1
Scale minimum	(SCAMIN)	See clause X.X	IN	0,1

INT 1 Reference: F 24

8.19.1 Gridirons (see S-4- B-326.8)

If it is required to encode a gridiron, it must be done using the feature **Gridiron**.

Remarks:

- Due to gridirons normally being located in intertidal areas, it is only required to encode **Gridiron** on the largest maximum display scale ENC data.

Distinction: Dry dock; floating dock.

8.20 Locks

IHO Definition: **LOCK BASIN.** A wet dock in a waterway, permitting a ship to pass from one level to another. (IHO Dictionary – S-32).

S-101 Geo Feature: Lock basin (LOKBSN)

Primitives: Surface

Real World

Paper Chart Symbol

ECDIS Symbol

S-101 Attribute	S-57 Acronym	Allowable Encoding Value	Type	Multiplicity
Feature name			C	0,*
Display name			(S) BO	0,1
Language		ISO 639-3	(S) TE	0,1
Name	(OBJNAM) (NOBJNM)		(S) TE	1,1
Fixed date range			C	0,1
Date end	(DATEND)	ISO 8601: 2004	(S) TD	0,1
Date start	(DATSTA)	ISO 8601: 2004	(S) TD	0,1
Horizontal clearance fixed			C	0,1
Horizontal clearance value	(HORCLR)		(S) RE	1,1
Horizontal distance uncertainty	(HORACC)		(S) RE	0,1
Horizontal length	(HORLEN)		RE	0,1
Horizontal width	(HORWID)		RE	0,1
Status	(STATUS)	1 : permanent 4 : not in use 6 : reserved 8 : private 13 : historic 14 : public 16 : watched 17 : un-watched	EN	0,*

INT 1 Reference: F 41.1

8.20.1 Locks (see S-4 – B-326.6)

A lock is an enclosure at the entrance to a canal or non-tidal basin. Its ends are closed by lock gates.

If it is required to encode a non-navigable lock basin, it must be done using the feature **Lock Basin**.

Remarks:

- If the lock is navigable at the maximum display scale of the ENC data, it must be encoded using the features **Depth Area** or **Dredged Area** (see clause X.X), and the geo features making up the limits of the lock must be encoded using appropriate features such as **Coastline**, **Shoreline Construction** or **Gate**. The lock must not be encoded as **Lock Basin**. If it is required to encode the name of the lock, it must be done using the feature **Sea Area/Named Water Area**.
- If it is required to encode a lock that is not navigable at the maximum display scale of the ENC data, it must be done using **Lock Basin**. The name of the lock should be encoded using the complex attribute **feature name** on the **Lock Basin** feature.
- **Lock Basin** are part of the Skin of the Earth.

- The gates should be encoded as a **Gate** feature (see clause X.X) with attribute **category of gate** = 4 (lock gate) or 3 (caisson). For smaller maximum display scale ENC data, a lock may be encoded using **Gate** only, without using **Lock Basin**.

Distinction: Canal; gate.

9 Geo Features – Topographic Terms

9.1 Sea area/named water area

IHO Definition: **SEA AREA/NAMED WATER AREA.** A geographically defined part of the sea or other navigable waters. It may be specified within its limits by its proper name. (S-57 Edition 3.1, Appendix A – Chapter 1, Page 1.151, November 2000).

S-101 Geo Feature: Sea area/named water area (SEAARE)

Primitives: Point, Surface

Real World

Paper Chart Symbol

ECDIS Symbol

S-101 Attribute	S-57 Acronym	Allowable Encoding Value	Type	Multiplicity
Category of sea area	(CATSEA)	2 : gat 3 : bank 4 : deep 5 : bay 6 : trench 7 : basin 8 : mud flats 9 : reef 10 : ledge 11 : canyon 12 : narrows 13 : shoal 14 : knoll 15 : ridge 16 : seamount 17 : pinnacle 18 : abyssal plain 19 : plateau 20 : spur 21 : shelf 22 : trough 23 : saddle 24 : abyssal hills 25 : apron 26 : archipelagic apron 27 : borderland 28 : continental margin 29 : continental rise 30 : escarpment 31 : fan 32 : fracture zone 33 : gap 34 : guyot 35 : hill 36 : hole 37 : levee 38 : median valley 39 : moat 40 : mountains 41 : peak 42 : province 43 : rise 44 : sea channel 45 : seamount chain	EN	0,1

		46 : shelf-edge 47 : sill 48 : slope 49 : terrace 50 : valley 51 : canal 52 : lake 53 : river 54 : reach 55 : intertidal cay 56 : submarine volcano		
Feature name			C	0,*
Display name			(S) BO	0,1
Language		ISO 639-3	(S) TE	0,1
Name	(OBJNAM) (NOBJNM)		(S) TE	1,1
Scale minimum	(SCAMIN)	See clause X.X	IN	0,1

INT 1 Reference:

9.1.1 Sea areas (see S-4 – B-550)

Undersea features and sea areas in general, including intertidal areas, may be identified by their names and may be delimited by the spatial types used by other geo features (for example depth contours, coastlines). If it is required to encode these areas, this must be done using the feature **Sea Area/Named Water Area**.

Remarks:

- At least one of the complex attribute **feature name** or the attribute **category of sea area** must be populated for **Sea Area/Named Water Area**.
- This feature has a use similar to that of the feature **Land Region** (see clause X.X), but for the sea.
- A **Sea Area/Named Water Area** feature of type surface should be bounded, if possible, by existing curves used by other features (for example **Depth Contour**, **Coastline**). If necessary, however, this surface may be bounded by other curves created to close the surface, or to describe a new surface.
- **Sea Area/Named Water Area** features of type surface may overlap.
- For additional guidance on encoding geographic names, see clause X.X.

Distinction: Administration area; depth area; seabed area.

10 Geo Features – Tides, Currents

10.1 Tidal data (see S-4 – B-406 to B-408)

The inclusion of tidal information in ECDIS is optional. As such, for ENC only tidal stream and current information is required to be encoded. The implementation of tidal models based on predictions or applications to incorporate real-time tidal observations in ECDIS will be the subject of additional Product Specifications utilising the S-100 Universal Hydrographic Data Model.

10.2 Tidal stream – flood/ebb

IHO Definition: TIDAL STREAMS. The alternating horizontal movement of water associated with the rise and fall of the tide caused by tide-producing forces. Also called tidal current. (IHO Dictionary – S-32).

Approximate tidal stream rates may be given as discrete rate values for flood and ebb flow during springs. (S-57 Edition 3.1, Appendix A – Chapter 1, Page 1.173, November 2000).

S-101 Geo Feature: Tidal stream – flood/ebb (TS_FEB)

Primitives: Point, Surface

Real World

Paper Chart Symbol

ECDIS Symbol

S-101 Attribute	S-57 Acronym	Allowable Encoding Value	Type	Multiplicity
Category of tidal stream	(CAT_TS)	1 : flood stream 2 : ebb stream 3 : other tidal flow	EN	1,1
Feature name			C	0,*
Display name			(S) BO	0,1
Language		ISO 639-3	(S) TE	0,1
Name	(OBJNAM) (NOBJNM)		(S) TE	1,1
Fixed date range			C	0,1
Date end	(DATEND)	ISO 8601: 2004	(S) TD	0,1
Date start	(DATSTA)	ISO 8601: 2004	(S) TD	0,1
Orientation			C	1,1
Orientation uncertainty			(S) RE	0,1
Orientation value	(ORIENT)		(S) RE	1,1
Speed			C	1,1
Speed maximum	(CURVEL)	speed maximum > speed minimum	(S) RE	1,1
Speed minimum		speed minimum < speed maximum	(S) RE	0,1
Scale minimum	(SCAMIN)	See clause X.X	IN	0,1

INT 1 Reference: H 40, 41

10.2.1 Tidal stream (flood/ebb) (see S-4 – B-407 and B-407.4)

The term “tidal streams” (French: “courants de mare”, US usage: “tidal currents”), is used to designate the periodical horizontal movements of the water, which are astronomical in origin. These are distinguished from “currents” (French: “courants généraux”), which are not dependent on astronomical conditions. In practice the navigator experiences a combination of tidal stream and current. Tidal streams are defined by the direction towards which they flow. The terms “flood stream” and “ebb stream” are used for designating the horizontal movement of the water when the tide is respectively rising or falling. To avoid any ambiguity, in the case of streams which do not turn at about the time of local high or low water, an indication must be given of the direction towards which the stream flows.

Where data are inadequate for tabulated information (**Tidal Stream Panel Data** – see clause X.X), or where otherwise required, single observations comprising flood and ebb directions and/or rates, preferably

corresponding to maximum rates at the spring tide, should be encoded.

If it is required to encode tidal stream information that is limited to flood and ebb directions and/or values, it must be done using the feature **Tidal Stream – Flood/Ebb**.

Remarks:

- Maximum rates (velocities) of tidal streams during springs, where known, must be encoded in knots using the complex attribute **speed**, and should be quoted to one decimal place. In rivers and estuaries where there are permanent currents caused by the flow of river water, such currents must be included in the calculation of the rate. Where the speed of the current in a river or estuary is so variable as to make it impractical to indicate a value, **speed** should be populated with an empty (null) value.

Distinction: Current – non-gravitational; tidal stream panel data.

10.3 Current – non-gravitational

<u>IHO Definition:</u> CURRENT – NON-GRAVITATIONAL. Any current that is caused by other than tide producing forces. Also called non-tidal current. (IHO Dictionary – S-32).				
S-101 Geo Feature: Current – non-gravitational (CURENT)				
Primitives: Point, Curve, Surface				
<i>Real World</i>		<i>Paper Chart Symbol</i>		<i>ECDIS Symbol</i>
S-101 Attribute	S-57 Acronym	Allowable Encoding Value	Type	Multiplicity
Feature name			C	0,*
Display name			(S) BO	0,1
Language		ISO 639-3	(S) TE	0,1
Name	(OBJNAM) (NOBJNM)		(S) TE	1,1
Fixed date range			C	0,1
Date end	(DATEND)	ISO 8601: 2004	(S) TD	0,1
Date start	(DATSTA)	ISO 8601: 2004	(S) TD	0,1
Orientation			C	1,1
Orientation uncertainty			(S) RE	0,1
Orientation value	(ORIENT)		(S) RE	1,1
Periodic date range			C	0,*
Date end	(PEREND)	ISO 8601: 2004	(S) TD	1,1
Date start	(PERSTA)	ISO 8601: 2004	(S) TD	1,1
Speed			C	1,1
Speed maximum	(CURVEL)	speed maximum > speed minimum	(S) RE	1,1
Speed minimum		speed minimum < speed maximum	(S) RE	0,1
Status	(STATUS)	5 : periodic/intermittent	EN	0,1
Scale minimum	(SCAMIN)	See clause X.X	IN	0,1
<u>INT 1 Reference:</u> H 42, 43				
10.3.1 Current data (see S-4 – B-408)				
The term “current(s)” in this document is used to describe water movements which are generally constant in direction, and are not dependent on astronomical conditions (that is, are non-gravitational). A current is described by the direction towards which it is running. For tidal streams, see clauses X.X and X.X.				
Currents occur as:				
<ul style="list-style-type: none"> • The flow of river water in rivers and estuaries; • Permanent flows in other restricted waters, for example İstanbul Boğazı (Bosporus); • Permanent or seasonal oceanic currents; • Temporary wind-induced currents. 				
Only surface currents should be encoded. It is particularly important to depict currents (both the main flows				

and permanent eddies) which could set a vessel towards dangers.

If it is required to encode a non-gravitational current, it must be done using the feature **Current – Non-gravitational**.

Remarks:

- Maximum rates (velocities) of currents, where known, must be encoded in knots using the complex attribute **speed**, and should be quoted to one decimal place. Ideally, the minimum and maximum strengths should be quoted, where known, if the strength varies.
- In tidal waters where the flow of river water alternately reinforces the ebb tidal stream and reduces the flood, the combined effect must be encoded, where required, for the convenience of the navigator; that is, the combined current must be encoded using the features **Tidal Stream – Flood/Ebb** or **Tidal Stream Panel Data** (see clauses X.X and X.X). In restricted waters where tides are negligible, the direction and/or rate of flow should be encoded using **Current – Non-gravitational**.
- Ocean currents are permanent or seasonal, are somewhat variable in strength and direction, and generally cover broad areas. Where required, this information must be encoded using **Current – Non-gravitational** of type surface. In cases where the current strength and direction are subject to seasonal variations, this should be indicated using the complex attribute **periodic date range**. This may require multiple **Current – Non-gravitational** features with attributes populated in accordance with the seasonal variations to be coincident in the ENC. Where the direction of an ocean current is so variable that it is not practicable to show this information, the complex attribute **orientation (orientation value)** must be populated with an empty (null) value. This may generally occur when the **Current – Non-gravitational** is encoded as type surface.
- Local weather conditions can produce significant temporary wind-induced currents which cannot be charted. If there is a known hazard, for example if winds from a particular direction have been found to endanger vessels by setting them on to shoals unexpectedly, a cautionary note may be added using the feature **Caution Area** (see clause X.X). If considered necessary, the note may refer to further information in other publications, such as Sailing Directions.

Distinction: Tidal stream (flood/ebb); tidal stream panel data.

10.4 Water turbulence

IHO Definition: **WATER TURBULENCE.** The disturbance of water caused by the interaction of any combination of waves, currents, tidal streams, wind, shoal patches and obstructions. (IHO Dictionary – S-32).

S-101 Geo Feature: Water turbulence (WATTUR)

Primitives: Point, Curve, Surface

Real World

Paper Chart Symbol

ECDIS Symbol

S-101 Attribute	S-57 Acronym	Allowable Encoding Value	Type	Multiplicity
Category of water turbulence	(CATWAT)	1 : breakers 2 : eddies 3 : overfalls 4 : tide rips 5 : bombora	EN	1,1
Feature name			C	0,*
Display name			(S) BO	0,1
Language		ISO 639-3	(S) TE	0,1
Name	(OBJNAM) (NOBJNM)		(S) TE	1,1
Scale minimum	(SCAMIN)	See clause X.X	IN	0,1

INT 1 Reference: H 44, 45; K 17

10.4.1 Overfalls, races, breakers, eddies (see S-4 – B-423)

If it is required to encode a disturbance of water, it must be done using the feature **Water Turbulence**.

Remarks:

- If it is required to encode a breaker over an off-lying shoal, it must be done using a **Water Turbulence** feature at the same position as the feature causing the breaker (for example **Underwater/Awash Rock**).
- A **Water Turbulence** feature of type surface must be covered by **Depth Area** or **Unsurveyed Area** features as appropriate.

Distinction: Rapids; waterfall.

10.5 Tidal stream panel data

IHO Definition: TIDAL STREAM PANEL DATA. A tidal stream (or tidal current) is an alternating horizontal movement of water associated with the rise and fall of the tide caused by tide-producing forces. (IHO Dictionary – S-32).

Approximate tidal stream rates may be given as discrete rate values at a specified interval before or after a high water. (S-57 Edition 3.1, Appendix A – Chapter 1, Page 1.176, November 2000).

S-101 Geo Feature: Tidal stream panel data (TS_PAD)

Primitives: Point, Surface

Real World

Paper Chart Symbol

ECDIS Symbol

S-101 Attribute	S-57 Acronym	Allowable Encoding Value	Type	Multiplicity
Feature name			C	0,*
Display name			(S) BO	0,1
Language		ISO 639-3	(S) TE	0,1
Name	(OBJNAM) (NOBJNM)		(S) TE	1,1
Station name	(TS_TSP)		TE	1,1
Station number	(TS_TSP)		IN	0,1
Tidal stream panel values	(TS_TSP)		C	1,* (ordered)
Reference tide		1 : high water 2 : low water	(S) EN	1,1
Reference tide type		1 : springs 2 : neaps 3 : mean	(S) EN	1,1
Stream depth			(S) RE	0,1
Tidal stream value			(S) C	1,* (ordered)
Orientation			(S) C	1,1
Orientation uncertainty			(S) RE	0,1
Orientation value	(ORIENT)		(S) RE	1,1
Speed maximum			(S) RE	1,1
Time relative to tide			(S) RE	1,1
Scale minimum	(SCAMIN)	See clause X.X	IN	0,1

INT 1 Reference: H 31,46

10.5.1 Tidal stream panels (see S-4 – B-407 and B-407.2-3)

The term “tidal streams” (French: “courants de mare”, US usage: “tidal currents”), is used to designate the periodical horizontal movements of the water, which are astronomical in origin. These are distinguished from “currents” (French: “courants généraux”), which are not dependent on astronomical conditions. In practice the navigator experiences a combination of tidal stream and current. Tidal streams are defined by the direction towards which they flow. The terms “flood stream” and “ebb stream” are used for designating the horizontal movement of the water when the tide is respectively rising or falling. To avoid any ambiguity, in the case of streams which do not turn at about the time of local high or low water, an indication must be given of the direction towards which the stream flows.

If it is required to encode the information generally shown on paper charts as a tidal stream panel and stations, it must be done using the feature **Tidal Stream Panel Data**.

Tidal stream values encoded in this way should be spring rates; that is, the tidal stream rates associated with a tidal range which is defined as the difference in height between MHWS and MLWS.

Remarks:

- The mandatory complex attribute **tidal stream panel values** is structured such that, in combination with attributes **station name** and **station number**, the equivalent layout of a paper chart tidal stream panel can be reproduced in an ECDIS Pick Report display. An example of the encoding of a **Tidal Stream Panel Data** feature as compared to the S-57 object class **TS_PAD** is included below:

S-57 Encoding: Population of attribute TS_TSP

0014,PLYMOUTH (DEVONPORT),HW,113,0.1,332,0.6,331,1.1,342,1.0,347,0.7,333,0.5,317,0.3,178,0.3,146,0.6,140,1.0,143,1.1,143,0.8,138,0.3

S-101 Encoding: (Complex attributes in italics, encoded values in blue text)

Tidal Stream Panel Data (feature)			
Station name	PLYMOUTH (DEVONPORT)		
Station number	0014		
<i>Tidal stream panel values</i>			
Reference tide	high water		
Reference tide type	springs		
<i>Tidal stream value</i>	<i>Orientation</i>	Orientation Value	113
	Speed maximum		0.1
	Time relative to tide		-6
<i>Tidal stream value</i>	<i>Orientation</i>	Orientation Value	332
	Speed maximum		0.6
	Time relative to tide		-5
<i>Tidal stream value</i>	<i>Orientation</i>	Orientation Value	331
	Speed maximum		1.1
	Time relative to tide		-4
<i>Tidal stream value</i>	<i>Orientation</i>	Orientation Value	342
	Speed maximum		1.0
	Time relative to tide		-3
<i>Tidal stream value</i>	<i>Orientation</i>	Orientation Value	347
	Speed maximum		0.7
	Time relative to tide		-2
<i>Tidal stream value</i>	<i>Orientation</i>	Orientation Value	333
	Speed maximum		0.5
	Time relative to tide		-1
<i>Tidal stream value</i>	<i>Orientation</i>	Orientation Value	317
	Speed maximum		0.3
	Time relative to tide		0
<i>Tidal stream value</i>	<i>Orientation</i>	Orientation Value	178
	Speed maximum		0.3
	Time relative to tide		1
<i>Tidal stream value</i>	<i>Orientation</i>	Orientation Value	146
	Speed maximum		0.6

		Time relative to tide	2
<i>Tidal stream value</i>	<i>Orientation</i>	Orientation Value	140
	Speed maximum		1.0
	Time relative to tide		3
<i>Tidal stream value</i>	<i>Orientation</i>	Orientation Value	143
	Speed maximum		1.1
	Time relative to tide		4
<i>Tidal stream value</i>	<i>Orientation</i>	Orientation Value	143
	Speed maximum		0.8
	Time relative to tide		5
<i>Tidal stream value</i>	<i>Orientation</i>	Orientation Value	138
	Speed maximum		0.3
	Time relative to tide		6

Distinction: Current – non-gravitational; tidal stream – flood/ebb.

11 Geo Features – Depths

11.1 Generalisation of depth portrayal

When a survey or chart is reduced in scale the generalization that is required has several effects:

- a. Deeper soundings tend to be eliminated while the shoaler ones are retained for safety. Sufficient numbers of deeper soundings should be retained to show the full range of depth. This is to assist the navigator who uses their echo sounder to help verify their position, or the mariner choosing an anchorage of suitable depth.
- b. Generalization proceeds by the inclusion of shoals lying to seaward of the principal contour, and by the smoothing of severely indented contours, with the effect of pushing the contours seaward. However, as a shoal which rises steeply from deep water is much more of a hazard than one which rises gradually, the encoder must ensure that the contours are not pushed seaward unduly. If the encoder gives the impression that a mariner will get warning of too close an approach to the danger, by relying on their echo sounder to show gradually shoaling depth - when the danger is, in fact “steep-to” - they may seriously mislead and endanger the ENC user.
- c. With the “expansion” of shoals, described above, it may become increasingly difficult to find space on an ENC dataset to show the line of deepest soundings through a channel, or even to show a channel at all. Yet even at small maximum display scales it is important to show the usable channels and indicate their least depth. The encoder may have to make greater use of depth contours than soundings in depicting narrow channels.
- d. Even such dangers as drying rocks and islets require generalization in coastal areas. This is in recognition of the principle that, whereas they are particularly dangerous in isolation and must then be shown as precisely as possible, where they occur in groups a representative depiction is permissible, showing the outermost features as individually as space permits.

11.2 Representation of depth: General

Some of the principles of depth depiction are summarized below:

- a. The least depth over shoals and banks, and over sills (bars) in navigable channels, must be shown. Particular attention should also be paid to full and accurate representation of all other “critical” areas, for example on and adjacent to leading lines, controlling depths in fairways and along recommended tracks, in anchorages, alongside jetties, quays and berths and in the entrances to harbours and basins. Maximum as well as minimum depth should be shown where possible, for example to show the line of deepest water in narrow channels. However, deeper soundings on the sloping side of a bank near to the crest line should not be selected if they could give the impression that there is a deeper passage across the crest between shoaler soundings.
- b. Soundings and contours must be used to complement each other in giving a reasonable representation of the seabed, including all significant breaks of slope.
- c. The density of soundings should be determined by the type of seabed. Flat or evenly sloping areas, and banks of unconsolidated sediment, should have a minimum of soundings, fairly evenly spaced, but gradually becoming more widely spaced as the depth increases. Irregular seabed topography should be represented by a denser, and probably irregular, pattern of soundings. A steep gradient should be represented by close contours, undistorted by soundings.
- d. In changeable areas, where surveys of different dates adjoin and do not match exactly, gaps in the contours may be left to indicate the discontinuity of depth to the navigator.
- e. Where practicable, soundings on smaller maximum display scale ENCs should be selected from those shown on the larger maximum display scale ENCs.
- f. In areas navigable only at high water, drying heights must be selected according to the same principles as soundings.
- g. Where surveys are inadequate, it may be advisable to omit some of the standard contour lines.

11.3 Sounding

IHO Definition: SOUNDING. Measured or charted depth of water (may be a drying height), or the measurement of such a depth, which has been reduced to a vertical datum. (Adapted from IHO Dictionary – S-32).

S-101 Geo Feature: Sounding (SOUNDG)

Primitives: Pointset

<i>Real World</i>	<i>Paper Chart Symbol</i>	<i>ECDIS Symbol</i>
-------------------	---------------------------	---------------------

S-101 Attribute	S-57 Acronym	Allowable Encoding Value	Type	Multiplicity
Feature name			C	0,*
Display name			(S) BO	0,1
Language		ISO 639-3	(S) TE	0,1
Name	(OBJNAM) (NOBJNM)		(S) TE	1,1
Quality of vertical measurement	(QUASOU)	1 : depth known 3 : doubtful sounding 4 : unreliable sounding 8 : value reported (not surveyed) 9 : value reported (not confirmed)	EN	0,*
Reported date	(SORDAT)	ISO 8601: 2004	TD	0,1
Status	(STATUS)	18 : existence doubtful	EN	0,1
Technique of vertical measurement	(TECSOU)	1 : found by echo-sounder 2 : found by side scan sonar 3 : found by multi-beam 4 : found by diver 5 : found by lead-line 6 : swept by wire-drag 8 : swept by vertical acoustic system 9 : found by electromagnetic sensor 10 : photogrammetry 11 : satellite imagery 12 : found by levelling 13 : swept by side-scan sonar 15 : found by LIDAR Xx : synthetic aperture radar Xx : hyperspectral Xx : etc?	EN	0,*
Vertical uncertainty	(SOUACC)		C	0,1
Uncertainty fixed			(S) RE	1,1
Uncertainty variable			(S) RE	0.1
Scale minimum	(SCAMIN)	See clause X.X	IN	0,1

INT 1 Reference: I 10, 14, 15

11.3.1 Soundings (see S-4 – B-412 and B-413.1)

A sounding associated with a rock or coral pinnacle which is an obstruction to navigation must be encoded using the feature **Underwater/Awash Rock** (INT1 – K14, see clause X.X) with attribute **value of sounding** populated with the value of the sounding.

The geometry of soundings and no bottom found depths (see clause X.X) is held in a 3 dimensional array (latitude, longitude, depth). In the interests of efficiency, multiple soundings should be encoded in one spatial type, provided that all the spatial and geo feature attributes are common to the group.

As the sounding multiplication factor (CMFZ) for ENC is 100, soundings may be encoded to two decimal places of a metre. Drying soundings must be indicated by a negative value.

For soundings surrounded by a danger line, see clause X.X.

Population of the attributes **quality of vertical measurement**, **source date** and the spatial attribute **quality of horizontal measurement** are described in the Table below:

Sounding	S-4	INT 1	quality of horizontal measurement	quality of vertical measurement	Remarks
In true position	B-412.1	I10		1or <undefined>	May be encoded using quality of horizontal measurement = 10
Out of position on paper chart	B-412.2	I11 I12		1or <undefined>	Spatial type must be encoded at the true position. There is no "sounding, out of position" in an ENC.
Lower reliability	B-412.4	I14	4	4	
Drying	B-413	I15		1or <undefined>	Negative value
Doubtful	B-424.4	I2		3	Existence doubtful should be encoded using status = 18
Reported but not confirmed		I3 I4	8	9	If available, the year of report must be encoded using the attribute reported date

Remarks:

- Encoders are advised to use caution when considering encoding soundings that are shoaler than the range of depth of the surrounding depth area, as **Sounding** features will not be displayed when utilising some ECDIS display settings. Where it is considered that a sounding that is shoaler than the range of depth of the surrounding depth area may be a hazard to navigation, encoders should preferably conduct further investigation of source material in order to encode additional depth contour and depth area information more relevant to the sounding. Alternatively, encoders may consider using an alternate feature (for example **Obstruction**) to encode the depth.
- The attribute **technique of vertical measurement** must only be populated for **Sounding** features if it is different from the value of **technique of vertical measurement** encoded on an overlapping **Quality of Survey** feature (see clause X.X); and the information is considered to be important to navigation.
- Where **Sounding** features are covered by the meta feature **Quality of Survey** (see clause X.X), the attribute **quality of vertical measurement** must not be populated unless different from the value of **quality of vertical measurement** populated for the **Quality of Survey**.
- For depths indicated as no bottom found, see clause X.X.

Distinction: Depth area; depth – no bottom found; obstruction; underwater/awash rock; wreck.

11.4 Dredged area

IHO Definition: **DREDGED AREA.** An area of the bottom of a body of water which has been deepened by dredging. (IHO Dictionary – S-32).

S-101 Geo Feature: Dredged area (DRGARE)

Primitives: Surface

<i>Real World</i>	<i>Paper Chart Symbol</i>	<i>ECDIS Symbol</i>
-------------------	---------------------------	---------------------

S-101 Attribute	S-57 Acronym	Allowable Encoding Value	Type	Multiplicity
Depth range minimum value	(DRVAL1)	DRVAL1 <= DRVAL2	RE	1,1
Depth range maximum value	(DRVAL2)	DRVAL2 >= DRVAL1	RE	0,1
Dredged date	(SORDAT)		TD	0,1
Feature name			C	0,*
Display name			(S) BO	0,1
Language		ISO 639-3	(S) TE	0,1
Name	(OBJNAM) (NOBJNM)		(S) TE	1,1
Maximum permitted draught			RE	0,1
Quality of vertical measurement	(QUASOU)	10 : maintained depth 11 : not regularly maintained	EN	0,1
Restriction	(RESTRN)	1 : anchoring prohibited 2 : anchoring restricted 3 : fishing prohibited 4 : fishing restricted 5 : trawling prohibited 6 : trawling restricted 8 : entry restricted 11 : diving prohibited 12 : diving restricted 13 : no wake 16 : discharging prohibited 17 : discharging restricted 18 : industrial or mineral exploration/development prohibited 19 : industrial or mineral exploration/development restricted 20 : drilling prohibited 21 : drilling restricted 23 : cargo transhipment (lightening) prohibited 25 : stopping prohibited 27 : speed restricted 39 : swimming prohibited	EN	0,*
Technique of vertical measurement	(TECSOU)	1 : found by echo-sounder 2 : found by side scan sonar 3 : found by multi-beam 6 : swept by wire-drag 8 : swept by vertical	EN	0,*

		acoustic system 9 : found by electromagnetic sensor 13 : swept by side-scan sonar 15 : found by LIDAR		
Vertical uncertainty	(<i>SOUACC</i>)		C	0,1
Uncertainty fixed			(S) RE	1,1
Uncertainty variable			(S) RE	0.1

INT 1 Reference: I 20-23

11.4.1 Dredged areas (see S-4 – B-414)

If it is required to encode dredged areas, this must be done using the feature **Dredged Area**.

Remarks:

- The attribute **depth range minimum value** must be used to encode the dredged depth for the dredged area. Where required, the attribute **depth range maximum depth** must be used to encode the deeper depth where a range of depths for the dredged area is indicated on the source.
- The boundary of a dredged area should not have coincident curve geo features encoded, unless part of the boundary corresponds to the shoreline (see clause X.X).
- Dredged areas are often subject to siltation, resulting in shoaler depths being identified in the dredged area than the designed dredged depth. Where required, the shoal depths should be encoded using **Sounding**, with the appropriate underlying depth information (**Depth Area** and, if required, **Depth Contour**) to support the depths. Alternatively, the attribute **depth range maximum value** for the **Dredged Area** may be set to the designed dredged depth for the dredged area, and the attribute **depth range minimum value** set to the value of the shoalest depth, or a **Caution Area** feature may be encoded covering the shoaler depth area with the depth information provided using an associated instance of the information class **Nautical Information** (see clause X.X), complex attribute **information**. Where the shoal depths are close to the edge of the dredged area, the dredged area limit may be adjusted to exclude the shoal depths from the surface. See also S-4 – B-414.5.
- The attribute **source date** may be used to encode the year of the latest control survey for dredged areas where the dredged depth is not maintained. For dredged areas where the dredged depth is maintained, it is not required to indicate the year of dredging.
- Where the complex attribute **vertical uncertainty** is populated for a **Dredged Area** feature, it must not be equivalent to or degrade the accuracy indicated by the complex attribute **vertical uncertainty** for the underlying **Quality of Bathymetric Data** meta feature (see clause X.X).
- **Dredged Area** features are part of the Skin of the Earth.

Distinction: Depth area; dumping ground; swept area.

11.5 Swept area

IHO Definition: **SWEPT AREA.** An area that has been determined to be clear of navigational dangers to a specified depth. (IHO Dictionary – S-32).

S-101 Geo Feature: Swept area (SWPARE)

Primitives: Surface

Real World

Paper Chart Symbol

ECDIS Symbol

S-101 Attribute	S-57 Acronym	Allowable Encoding Value	Type	Multiplicity
Depth range minimum value	(DRVAL1)		RE	1,1
Quality of vertical measurement	(QUASOU)	1 : depth known 6 : least depth known	EN	0,*
Swept date	(SORDAT)		TD	0,1
Technique of vertical measurement	(TECSOU)	6 : swept by wire-drag 8 : swept by vertical acoustic system 13 : swept by side-scan sonar	EN	0,*
Vertical uncertainty	(SOUACC)		C	0,1
Uncertainty fixed			(S) RE	1,1
Uncertainty variable			(S) RE	0.1
Scale minimum	(SCAMIN)	See clause X.X	IN	0,1

INT 1 Reference: I 24

11.5.1 Swept areas (see S-4 – B-415)

If it is required to encode a swept area, it must be done using the feature **Swept Area**.

Spot soundings and depth contours shown in these areas must be encoded using **Sounding** and **Depth Contour** features. Attributes **quality of vertical measurement**, **technique of vertical measurement** and complex attribute **vertical uncertainty** encoded on **Swept Area** apply to the swept area only. When it is required to encode the quality of spot soundings and depth contours, it must be done using the meta feature **Quality of Bathymetric Data** (see clause X.X).

Even if the area contains no spot soundings or depth contours, a **Swept Area** feature must overlap **Depth Area** or **Dredged Area** features. If there is insufficient depth information to allow the attributes **depth range minimum value** and **depth range maximum value** to be encoded on a **Depth Area** or **Dredged Area** feature, **depth range minimum value** should be set to the swept depth and **depth range maximum value** should be set to an empty (null) value.

Remarks:

- The attribute **depth range minimum value** must be used to encode the swept depth for the swept area.
- When a swept area occupies an entire **Quality of Bathymetric Data** surface feature and a **Swept Area** feature is not defined separately, **depth range minimum value** for the **Quality of Bathymetric Data** feature must be used to encode the swept depth. The complex attribute **vertical uncertainty** may be used on the **Quality of Bathymetric Data** feature to specify the accuracy of the swept depth defined by **depth range minimum value** - the attribute **horizontal position uncertainty** must not be used. There must be no depth or positional accuracy information provided for any underlying soundings within the swept area.
- When a swept area occupies an entire **Quality of Bathymetric Data** surface feature and a **Swept Area** feature is defined separately, the **depth range minimum value** encoded on the **Quality of Bathymetric Data** feature must be the same as the **depth range minimum value** encoded on the **Swept Area** feature.

Vertical uncertainty may be used on the **Quality of Bathymetric Data** feature to specify the accuracy of the swept depth - **horizontal position uncertainty** must not be used. There must be no depth or positional accuracy information provided for any underlying soundings within the swept area.

- When a **Swept Area** feature exists within a **Quality of Bathymetric Data** feature, **vertical uncertainty** must only be used on the **Quality of Bathymetric Data** feature if the same depth accuracy applies to the swept depth and to the soundings outside the swept area. **Horizontal position uncertainty** must only be used to encode the accuracy of depths falling outside the boundaries of the swept area. There must be no depth or positional accuracy information provided for any underlying soundings within the swept area.
- Where required, the date of sweeping must be populated using the attribute **swept date**.
- **Swept Area** features must not overlap.

Distinction: Depth area; dredged area; unsurveyed area.

11.6 Depth contour

IHO Definition: DEPTH CONTOUR. A line connecting points of equal water depth which is sometimes significantly displaced outside of soundings, symbols and other chart detail for clarity as well as generalization. Depth contours, therefore, often represent an approximate location of the line of equal depth as related to the surveyed line delineated on the source. Also referred to as depth curve. (IHO Dictionary – S-32).

S-101 Geo Feature: Depth contour (DEPCNT)

Primitives: Curve

Real World

Paper Chart Symbol

ECDIS Symbol

S-101 Attribute	S-57 Acronym	Allowable Encoding Value	Type	Multiplicity
Value of depth contour	(VALDCO)		RE	1,1
Scale minimum	(SCAMIN)	See clause X.X	IN	0,1

INT 1 Reference: I 15, 30, 31

11.6.1 Depth contours (see S-4 – B-404.2; B-410; B-411 to B-411.5; B-413 and B-413.1)

The standard series of depth contour lines to be encoded for ENC is: drying line (0 contour – where tides are appreciable), 2, 5, 10, 15, 20, 30, 50, 100, 200, 300, 400, 500, 1000, 2000 metres, etc. The 2, 5 and/or 15 metre contours may be omitted where they serve no useful purpose, and on smaller maximum display scale ENC data all depth contours to 30 metres (1:1500000 and 1:3000000 maximum display scales) or 200 metres (1:10000000 maximum display scale) should be omitted. It is not necessary for the complete sequence of contours to be shown, for example on steep slopes and around isolated pinnacles.

Supplementary contours, for example at 3, 8, 25, 40, 75 metres and multiples of 10 or 100 metres may be shown, if the available data permit, to delineate particular bathymetric features where soundings would otherwise be the only depth information over a large area, or for the benefit of particular categories of shipping. The 2500 metre contour may be required for measuring Continental Shelf limits (see UNCLOS Article 76).

On the larger maximum display scale ENC datasets, for example datasets intended for harbour navigation or berthing; or in areas where vessel under keel clearance is critical, a smaller contour interval may be used (for example 1 metre) in the depth range suitable for the deepest draught vessels that may navigate in the area.

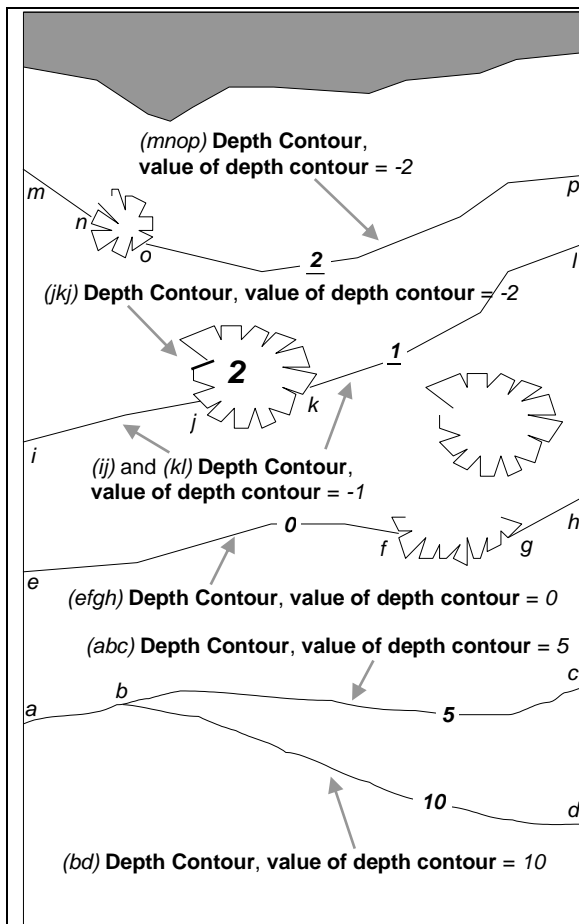

The boundary of a drying rocky area (see INT1 - J20) or coral reef (see INT1 - J22) may be coincident with the zero metre contour (see 'fg' in Figure). If it is required to encode this boundary, it must be done using the feature **Depth Contour** with the attribute **value of depth contour = 0**.

On the source, the presentation of contours in areas of steep slope is sometimes generalised so that closely spaced contours are removed to leave a single contour (see 'ab' in Figure). In such cases, this contour must be encoded using the shallowest depth of the slope.

Wherever possible, contours must be closed, or connected to the border of the dataset, a coastline feature or another contour, in order to define closed areas.

Spatial types associated with contours derived from inadequate bathymetric source information should be encoded using the attribute **quality of horizontal measurement = 4** (approximate).

Remarks:

- Encoded drying contours must be indicated by negative values for the attribute **value of depth contour**.

Distinction: Coastline; depth area; sounding.

11.7 Depth area

IHO Definition: DEPTH AREA. A water area whose depth is within a defined range of values. (S-57 Edition 3.1, Appendix A – Chapter 1, Page 1.51, November 2000).

S-101 Geo Feature: Depth area (DEPARE)

Primitives: Surface

Real World

Paper Chart Symbol

ECDIS Symbol

S-101 Attribute	S-57 Acronym	Allowable Encoding Value	Type	Multiplicity
Depth range minimum value	(DRVAL1)	DRVAL1 < DRVAL2	RE	1,1
Depth range maximum value	(DRVAL2)	DRVAL2 > DRVAL1	RE	1,1

INT 1 Reference:

11.7.1 Depth areas (see S-4 – B-410)

The sea area, the intertidal area and the navigable parts of rivers, lakes and canals must be divided into depth areas, each of them having a range of depth.

As many depth areas as possible must be created using encoded depth contours.

Remarks:

- The value of **depth range maximum value** for the deepest **Depth Area** on the ENC dataset should be encoded with the next deepest depth contour from the standard range of depth contours appropriate to the maximum display scale of the ENC data (see clause X.X), noting that the depth ranges used for adjoining ENC datasets of the same or similar maximum display scale must also be considered.
- Depth Area** features are part of the Skin of the Earth.

11.7.2 Geometry of depth areas

Where surfaces are not closed on the source, it may be necessary to close these surfaces using edges without associated curve features. This is mandatory at the boundary of a dataset (see Figure below).

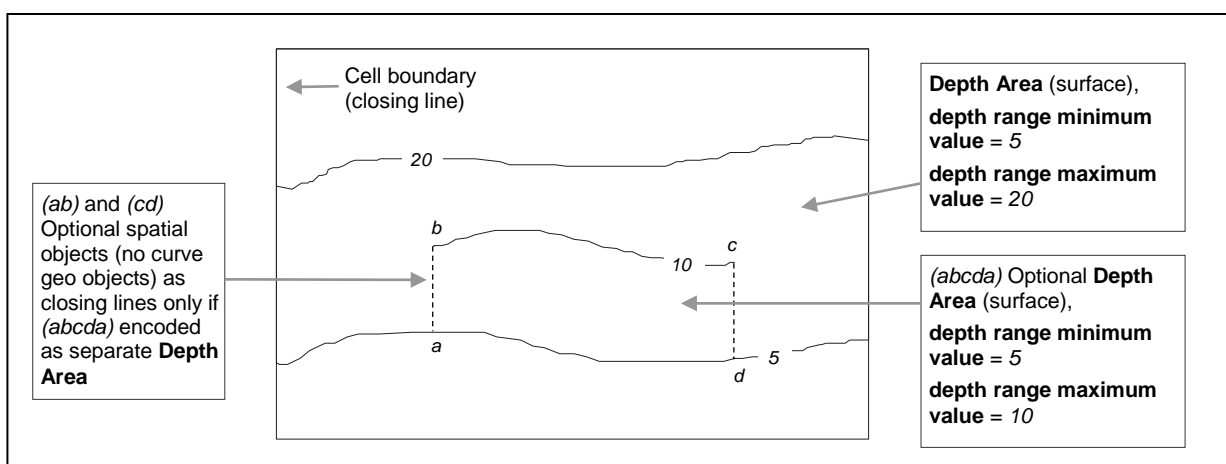

Remarks:

- For short isolated sections of **Depth Contour** features such as (bc) , it is up to the producing authority whether to encode the small area $(abcd)$ as a separate **Depth Area** feature, or to encode only the curve (bc) as a floating **Depth Contour** feature within a single **Depth Area** having attributes **depth range minimum value = 5** and **depth range maximum value = 20**.

11.7.3 Use of attributes **depth range minimum value** and **depth range maximum value** for depth areas in general

For each depth area, **depth range minimum value** and **depth range maximum value** should be encoded with the values corresponding to the shallowest and deepest depths in that area. These values, except for the shallowest and deepest areas, should be chosen from the values of the depth contours encoded in the dataset.

A drying area, within which a drying height is indicated without a true position, should be encoded using a **Depth Area** feature, with **depth range minimum value** set to the value of the drying height and **depth range maximum value** set to a dataset contour value (usually zero). Alternatively, **depth range minimum value** for the **Depth Area** may be set to $-H$ (see NOTE (a) associated with Figure below for definition of H), with the drying height encoded using an associated instance of the information class **Nautical Information** (see clause X.X), complex attribute **information**, sub-attribute **text** (for example *Dries 1.4*).

If a depth area is adjacent to a non-navigable waterway, a closing curve (that is, no curve geo feature) should be encoded at the boundary between navigable and non-navigable waters. See clause X.X.

In the Figure below, the annotation “min” equates to the attribute **depth range minimum value** and the annotation “max” equates to the attribute **depth range maximum value**.

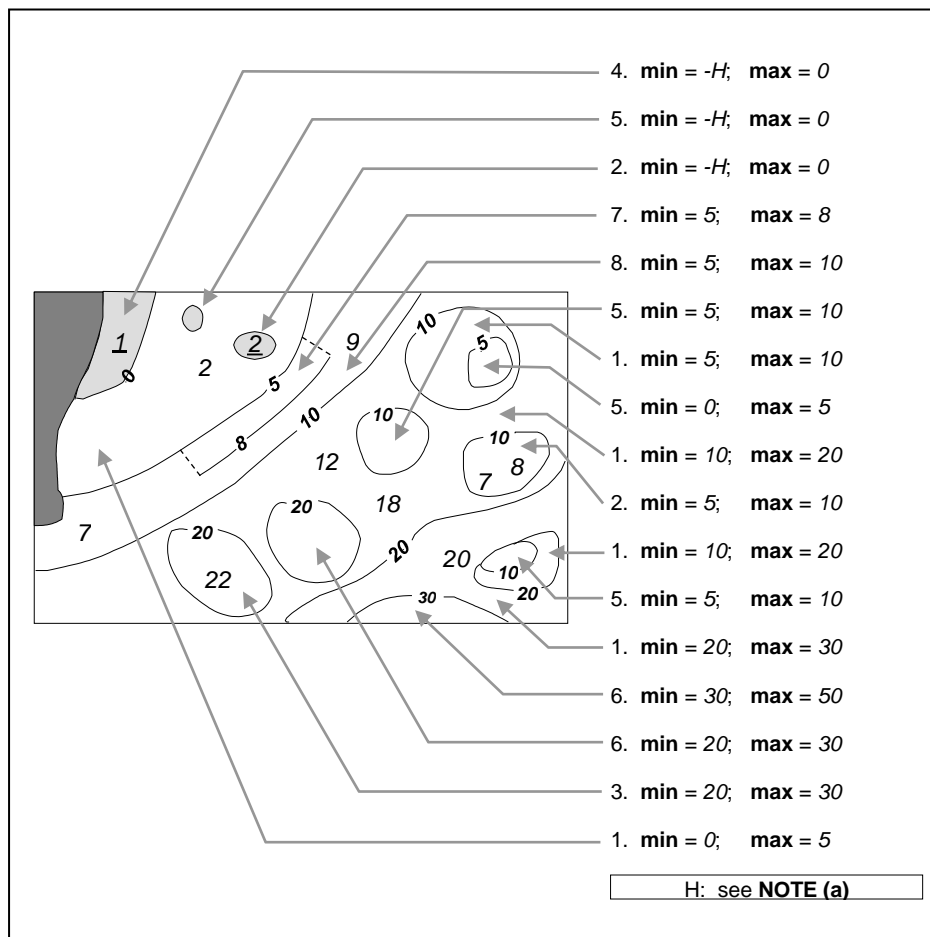

NOTE (a): H = Height of the coastline datum above sounding datum, or a rounded value (for example (1) the value of the highest drying contour indicated on the source document; or (2) zero, if the coastline datum is the same as the sounding datum).

In the following clauses, the paragraph numbers refer to the item numbers in the above Figure. These clauses do not cover all encoding scenarios.

1. If the depth area is bounded by two or more depth contours:

- **depth range minimum value** should take the value of the dataset depth contour immediately shallower than the value of **depth range maximum value**.

- **depth range maximum value** should take the value of the deepest depth contour bounding the area.
2. If the deepest depth is shown by a depth contour, and the shallowest depth is shown by a sounding (a shoal):
 - **depth range minimum value** should take the value of the dataset depth contour immediately shallower than the value of the sounding or -H.
 - **depth range maximum value** should take the value of the depth contour.
 3. If the deepest depth is shown by a sounding and the shallowest depth is shown by a depth contour (a deep):
 - **depth range minimum value** should take the value of the depth contour.
 - **depth range maximum value** should take the value of the dataset depth contour immediately deeper than or equal to the value of the sounding.
 4. If the shallowest depth is defined by the coastline:
 - **depth range minimum value** should take the value of -H.
 - **depth range maximum value** should take the value of the shallowest dataset depth contour bounding the area.
 5. If the depth area is bounded by only one depth contour, contains no soundings, and is a shoal:
 - **depth range minimum value** should take the value of the dataset depth contour immediately shallower than the value of the depth contour, or -H.
 - **depth range maximum value** should take the value of the depth contour.
 6. If the depth area is bounded by only one depth contour, contains no soundings, and is a deep:
 - **depth range minimum value** should take the value of the depth contour.
 - **depth range maximum value** should take the value of the standard depth contour immediately deeper than the value of the depth contour.
 7. If the depth area is bounded by an incomplete depth contour on one side (such as in incompletely surveyed area), and a complete depth contour on the other:
 - This area is optional. See clause X.X above and associated Figure.
 8. If the depth area is bounded by complete depth contours, but contains an incomplete (floating) depth contour:
 - **depth range minimum value** should take the value of the shallowest depth contour.
 - **depth range maximum value** should take the value of the deepest depth contour.
- NOTE: This encoding is mandatory whether the optional depth area in paragraph 7 above is encoded or not.

11.7.4 Rivers, canals, lakes, basins, locks

Where these areas are navigable at the maximum display scale for the ENC data, they must be encoded using the Skin of the Earth features **Depth Area**, **Dredged Area** or **Unsurveyed Area**, and coastline-type features **Coastline** or **Shoreline Construction**. If it is required to encode the nature and name of the area, it must be done using the feature **Sea Area/Named Water Area**.

Where these areas are required and are not navigable at the maximum display scale for the ENC data, they must be encoded using the features **River**, **Canal** or **Lake**. These features must be covered by **Land Area** features.

11.7.5 Areas of continual change (see S-4 – B-416)

If it is required to encode an area of continually changing bathymetry, it must be done by populating the attribute **category of temporal variation** = 2 (likely to change) for the underlying **Quality of Bathymetric Data** feature (see clause X.X).

Such areas must always overlap **Depth Area** features.

An area on the source with the indication "Less water" should be encoded using the feature **Caution Area** (see clause X.X). Caution notes in such areas must be encoded using an associated instance of the information class **Nautical Information** (see clause X.X), complex attribute **information**.

If it is required to encode sandwaves, this must be done using the feature **Sandwave** (see clause X.X).

Distinction: Depth contour; dredged area; obstruction; sea area/named water area; sounding; unsurveyed area; wreck.

11.8 Depth – no bottom found

IHO Definition: **DEPTH – NO BOTTOM FOUND.** Upon investigation the bottom was not found at this depth. (Adapted from IHO Dictionary – S-32).

S-101 Geo Feature: Depth – no bottom found

Primitives: Pointset

Real World

Paper Chart Symbol

ECDIS Symbol

S-101 Attribute	S-57 Acronym	Allowable Encoding Value	Type	Multiplicity
Technique of vertical measurement	(TECSOU)	1 : found by echo-sounder 2 : found by side scan sonar 3 : found by multi-beam 5 : found by lead-line 6 : swept by wire-drag 8 : swept by vertical acoustic system 9 : found by electromagnetic sensor 13 : swept by side-scan sonar 15 : found by LIDAR	EN	0,*
Scale minimum	(SCAMIN)	See clause X.X	IN	0,1

INT 1 Reference: I 13

11.8.1 No bottom found depths (see S-4 – B-412.3)

If it is required to encode a depth at a point at which it is indicated as having no bottom found at the value shown, it must be done using the feature **Depth – No Bottom Found**.

The geometry of soundings (see clause X.X) and no bottom found depths is held in a 3 dimensional array (latitude, longitude, depth). In the interests of efficiency, multiple no bottom found depths should be encoded in one spatial type, provided that all the spatial and geo feature attributes are common to the group.

Even though the sounding multiplication factor (CMFZ) for ENC is 100, no bottom found depths must be encoded to a whole metre value.

Remarks:

- For encoding areas that have been systematically surveyed and for which the depth has not been found (for example, for LIDAR surveys), see clause X.X.

Distinction: Depth area; sounding; swept area.

11.9 Areas with inadequate depth information

11.9.1 Inadequately surveyed areas (see S-4 – B-417)

Inadequately surveyed areas may be defined as those areas where bathymetry is based on older lead line surveys or other surveys which are either open in nature (for example reconnaissance surveys), or are not hydrographic surveys (for example seismic surveys). These types of surveys are inadequate for identifying all shoals that may exist between lines of soundings, or may not be “shoal-biased” in their selection of recorded depths.

An inadequately surveyed area should be encoded using either an **Unsurveyed Area** feature, within which soundings and contours may be encoded (but not depth areas), or using **Depth Area** features. The attributes **depth range minimum value** and **depth range maximum value** for such depth areas should have explicit values.

The area must also be covered by **Quality of Bathymetric Data** features (see clause X.X), having appropriate attribute values, usually **category of temporal variation** = 5 (unassessed), **features detected (significant features detected)** = *False*, and **full seafloor coverage achieved** = *False*. Further information may be given using the meta feature **Quality of Survey** (see clause X.X), where appropriate.

A cautionary note should also be encoded using a **Caution Area** feature of type surface (see clause X.X), with an associated instance of the information class **Nautical Information** (see clause X.X).

11.9.2 Bathymetry in areas of minimal depiction of detail on paper charts

Where areas of little or no depth information exist within a specified ENC usage, they should be encoded using one of the following options:

11.9.2.1 Areas of omitted bathymetry

Encoders are advised that when encoding areas of bathymetry from paper charts containing minimal depth detail at scales that correspond to the maximum display scale for the data, to consult larger scale paper charts or maximum display scale ENC datasets and generalise the bathymetry from this data. This is done to ensure that sufficient information is encoded so as not to conflict with larger maximum display scale coverage. The following is the recommended minimum encoding requirement in such cases:

Where larger maximum display scale ENC coverage is available, the larger scale datasets should be examined to determine the shallowest **Depth Area** feature, other than the intertidal area, within the whole of the area. Intertidal areas should then be generalised from the larger maximum display scale coverage, and one **Depth Area** feature may then be created, with attributes **depth range minimum value** and **depth range maximum value** encoded from the values obtained from the larger scale, corresponding to the remaining area of bathymetry.

Where larger maximum display scale coverage does not exist, a single **Depth Area** feature may be created to cover the area of omitted bathymetry. The **depth range minimum value** of the **Depth Area** feature should be set to the shallowest value appropriate to the colour tint that is applied to it (for example if blue tint is used for 5-20m areas, the **depth range minimum value** for the area of omitted bathymetry should be set to 5). The **depth range maximum value** should be set to the shallowest value of the surrounding Skin of the Earth polygons.

In either case, the areas should be covered by a **Caution Area** feature, the boundary of which follows exactly the surrounding Skin of the Earth features (see clause X.X).

Encoders should consider the effect of over-generalising areas of omitted bathymetry on the ECDIS display as the mariner “zooms out” through the ENC display scales.

11.9.2.2 Areas of very simplified bathymetry

In these areas, information relating to bathymetry (for example depth contours, dangers, rocky areas, isolated rocks, nature of the seabed, dredged areas, unsurveyed areas) should be individually encoded as normal.

A **Caution Area** feature (see clause X.X) should be created covering the **Depth Area** features, within the area of simplified bathymetry, with an associated instance of the information class **Nautical Information** (see clause X.X), in order to encode a cautionary note.

11.9.3 Depth discontinuities between surveys (see S-4 – B-416.1)

Depth discontinuities between adjoining or overlapping source bathymetric surveys may be caused by:

- Surveys in areas of continually changing depth (see clause X.X) conducted with a significant time gap between the surveys; or
- Adjoining areas having significant differences in the quality of bathymetric data (see clause X.X).

It may not be possible to safely resolve significant depth discontinuity by interpolating approximate depth contours, which may compromise the ability for the compiler to adequately encode complete, non-overlapping Group 1 coverage of the area of the ENC cell covered by data. Where it is required to indicate these significant depth discontinuities, it should be done by encoding a “very narrow” **Unsurveyed Area** feature.

The “very narrow area” should be about 0.2mm in width at maximum display scale for the ENC data.

Remarks:

- An indication of the purpose of the **Unsurveyed Area** may be done by population of an associated instance of the information class **Nautical Information** (see clause X.X), complex attribute **information**, sub-attribute **text**, for example *Discontinuity between surveys*.
- In order to provide an indication to the mariner of the more reliable encoded bathymetry in an area of continually changing depth, the defining attributes should be downgraded for the **Quality of Bathymetric Data** feature (see clause X.X) corresponding to the less reliable (or older) data.

11.9.4 Satellite imagery as source information

In some areas source information may be limited to shallow water depth information derived from satellite imagery. Where defined depths can be interpolated from satellite imagery (for example the drying line, 5 metre or 10 metre depth contours), and little or no reliable source survey information exists in the area, consideration should be given to showing this information in ENCs.

If it is required to encode shoal areas which have been derived from satellite imagery, **Depth Area** and **Depth Contour** features of an appropriate depth range should be used. This should only be done in areas which have not been systematically surveyed. Areas of depth information derived from satellite imagery should be covered by **Quality of Bathymetric Data** meta features (see clause X.X) having appropriate attribute values, usually **category of temporal variation** = 5 (unassessed), **features detected (significant features detected)** = *False*, and **full seafloor coverage achieved** = *False*. Optionally, the area may also be covered by a **Quality of Survey** feature (see clause X.X), having attribute **technique of vertical measurement** = 11 (satellite imagery).

11.10 Unsurveyed area

IHO Definition: **UNSURVEYED AREA.** An area where hydrographic survey data is non-existent. (IHO Dictionary – S-32).

S-101 Geo Feature: **Unsurveyed area (UNSARE)**

Primitives: **Surface**

Real World

Paper Chart Symbol

ECDIS Symbol

INT 1 Reference: I 25

11.10.1 Unsurveyed areas (see S-4 – B-418)

Unsurveyed areas may be defined as those within which there is no available data derived from a systematic hydrographic survey. This may include areas which only have lines of passage soundings and/or other miscellaneous data such as isolated ship's reports.

Areas with little or no bathymetric survey information must be encoded using the feature **Unsurveyed Area**.

The area must also be covered, where required, by **Quality of Bathymetric Data** features (see clause X.X), with attributes **category of temporal variation** = 5 (unassessed), **data assessment** = 1 (assessed), **features detected (least depth of detected features measured and significant features detected)** = *False*; **full seafloor coverage achieved** = *False*; **horizontal position uncertainty** = [empty (null)] and **vertical position uncertainty** = [empty (null)].

Remarks:

- **Unsurveyed Area** features are part of the Skin of the Earth.

Distinction:

12 Geo Features – Nature of the Seabed

12.1 Seabed area

IHO Definition: SEABED AREA. A region of the seabed including the material of which it is composed and its physical characteristics. Also called nature of bottom, character (or characteristics) of the bottom, or quality of the bottom. (Adapted from IHO Dictionary – S-32).

S-101 Geo Feature: Seabed area (SBDARE)

Primitives: Point, Curve, Surface

<i>Real World</i>	<i>Paper Chart Symbol</i>	<i>ECDIS Symbol</i>
-------------------	---------------------------	---------------------

S-101 Attribute	S-57 Acronym	Allowable Encoding Value	Type	Multiplicity
Feature name			C	0,*
Display name			(S) BO	0,1
Language		ISO 639-3	(S) TE	0,1
Name	(OBJNAM) (NOBJNM)		(S) TE	1,1
Surface characteristics			C	1,* (ordered)
Nature of surface	(NATSUR)	1 : mud 2 : clay 3 : silt 4 : sand 5 : stone 6 : gravel 7 : pebbles 8 : cobbles 9 : rock 11 : lava 14 : coral 17 : shells 18 : boulder	(S) EN	0,1
Nature of surface – qualifying terms	(NATQUA)	1 : fine 2 : medium 3 : coarse 4 : broken 5 : sticky 6 : soft 7 : stiff 8 : volcanic 9 : calcareous 10 : hard	(S) EN	0,3
Underlying layer			(S) IN	0,1
Water level effect	(WATLEV)	3 : always under water/ submerged 4 : covers and uncovers 5 : awash	EN	0,1
Scale minimum	(SCAMIN)	See clause X.X	IN	0,1

INT 1 Reference: J 1-12, 30-39

12.1.1 Description of the seabed (see S-4 – B-425 to B-427)

The nature (quality) of the seabed (bottom) must be shown in sufficient detail, where known and on the appropriate maximum display scale ENC data, for such purposes as:

- to give some guidance on holding characteristics when anchoring;
- to help in assessing the stability of shoals and to distinguish rocks from unconsolidated material, when navigating in shoal areas;
- to show where vessels may safely take the ground at low water in tidal areas; or
- to give an indication of the nature of the seabed in deeper waters for fishermen and submariners.

If it is required to encode an area of the sea where the nature of the seabed is homogeneous, it must be done using the feature **Seabed Area**.

Remarks:

- Generally, it is not possible to define a seabed area by its real extent, due to seabed samples usually being obtained at discrete locations. For that reason, the characteristics of the seabed area may be represented at one single position.
- For the mandatory complex attribute **surface characteristics**, at least one of the sub-attributes **nature of surface** or **nature of surface – qualifying terms** must be populated.
- Where the seabed comprises a mixture of material, **surface characteristics** must be populated as multiple iterations, with the main constituent given first.
- Where the seabed comprises layered material that is of relevance to navigation or anchoring, **surface characteristics** must be populated as multiple iterations, with the surface constituent given first, with a value for the attribute **underlying layer** of 0. Successive layers below the surface must have **underlying layer** set to 1, 2,

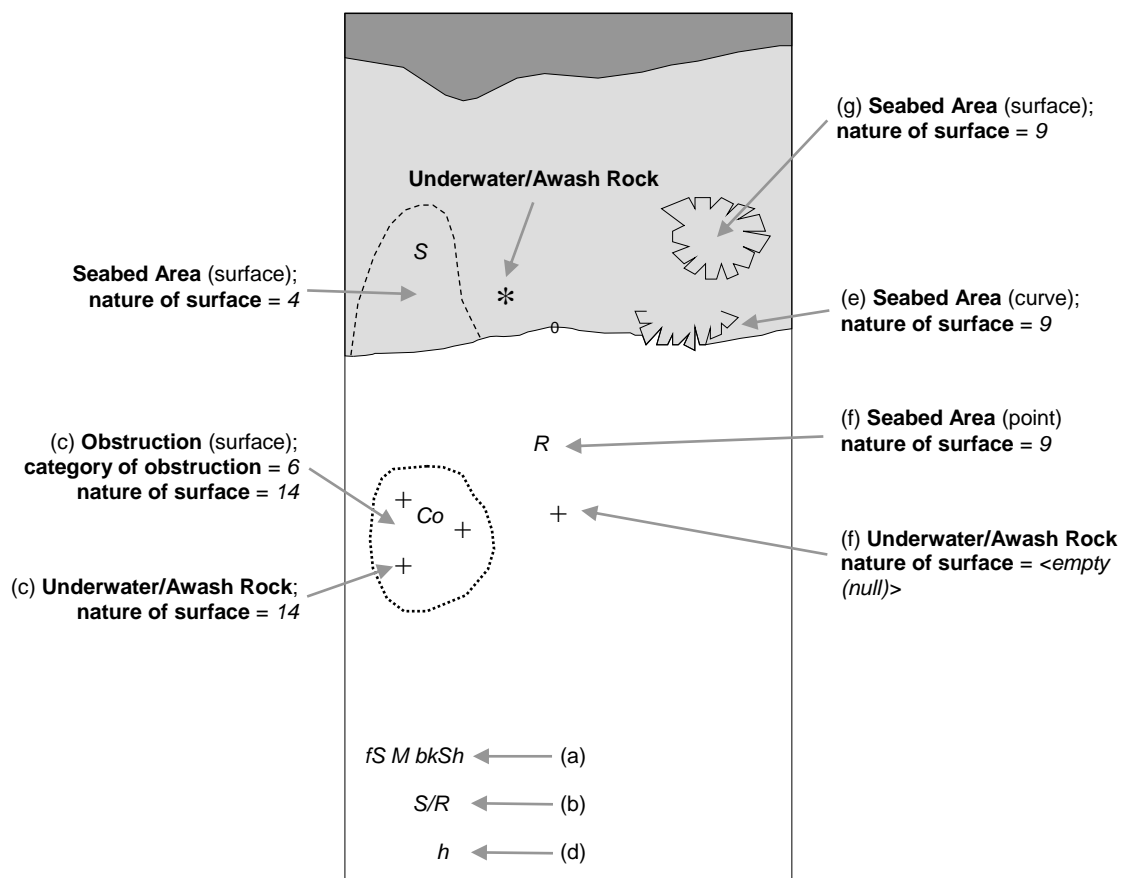

- In the following clauses, the paragraph prefixes refer to the examples shown in the Figure above.

(a) Mixed natures: The dominant nature of the seabed (**nature of surface**) should be populated first, along with its associated qualifying term (**nature of surface – qualifying terms**), if required, using the complex attribute **surface characteristics**. Other natures should then be populated, in order of dominance, using further ordered instances of **surface characteristics**,

- (b) Underlying material: Should be encoded in the same way as mixed natures, and populating the sub-attribute **underlying layer** with the appropriate level of the layer below the surface layer. The surface layer must be encoded first, followed by the underlying layers.
- (c) Coral reef, which is always covered, represented as a surface (INT1 – K16): An **Obstruction** feature of type surface must be encoded with attributes **category of obstruction** = 6 (foul area), **nature of surface** = 14 (coral) and **water level effect** = 3 (always underwater/submerged). This feature must be covered by a **Depth Area** or **Unsurveyed Area** feature as appropriate. In this area, some point dangers may be shown. An **Underwater/Awash Rock** feature should be encoded for each individual point danger, with **nature of surface** = 14 (coral).
- (d) Hard bottom: The attribute **nature of surface – qualifying terms** = 10 (hard) should be encoded, with the associated **nature of surface** populated with an empty (null) value.
- (e) On the source, in the intertidal area or along the drying line, the nature of surface is sometimes shown by an open line rather than a closed area. In such cases, a **Seabed Area** feature of type curve should be encoded, with attribute **water level effect** = 4 (covers and uncovers).
- (f) If it is required to encode a rock pinnacle which is dangerous to navigation, it must be done using the feature **Underwater/Awash Rock**, while a rocky nature of seabed should be encoded using a **Seabed Area** feature.
- (g) Where a **Seabed Area** feature of type surface is located in an intertidal area, it should be encoded with **water level effect** = 4 (covers and uncovers), in order for the intertidal rock or coral symbol to be displayed in ECDIS.
- The nature of the seabed should be shown in depths of 2000m and less. The nature of the seabed may be shown in greater depths if thought to be useful.

Distinction: Sandwave; sea area/named water area; weed/kelp.

12.2 Weed/kelp

IHO Definition: **WEED/KELP.** Marine plants of the Algae class which grow in long narrow ribbons. (International Maritime Dictionary, 2nd Edition).

S-101 Geo Feature: Weed/kelp (WEDKLP)

Primitives: Point, Surface

Real World

Paper Chart Symbol

ECDIS Symbol

S-101 Attribute	S-57 Acronym	Allowable Encoding Value	Type	Multiplicity
Category of weed/kelp	(CATWED)	1 : kelp 2 : seaweed 3 : seagrass 4 : sargasso	EN	0,1
Feature name			C	0,*
Display name			(S) BO	0,1
Language		ISO 639-3	(S) TE	0,1
Name	(OBJNAM) (NOBJNM)		(S) TE	1,1
Scale minimum	(SCAMIN)	See clause X.X	IN	0,1

INT 1 Reference: J 13.1, 13.2

12.2.1 Weed - Kelp (see S-4 – B-428.2)

If it is required to encode marine weed or kelp, it must be done using the feature **Weed/Kelp**.

Remarks:

- For the mariner, the presence of kelp is also generally an indication of the presence of submerged rocks.

Distinction: Seabed area; vegetation.

12.3 Sandwaves

IHO Definition: **SANDWAVE.** Large mobile wave-like sediment feature in shallow water and composed of sand. The wave length may reach 100 metres; the amplitude may be up to 20 metres. Also sand-wave or sand wave. Sometimes called a mega-ripple. (IHO Dictionary – S-32).

S-101 Geo Feature: Sandwave (SNDWAV)

Primitives: Point, Curve, Surface

Real World

Paper Chart Symbol

ECDIS Symbol

S-101 Attribute	S-57 Acronym	Allowable Encoding Value	Type	Multiplicity
Vertical length	(VERLEN)		RE	0,1
Scale minimum	(SCAMIN)	See clause X.X	IN	0,1

INT 1 Reference: J 14

12.3.1 Sandwaves (see S-4 – B-428.1)

Sandwave areas may be dangerous to mariners, as the depth may be less than charted, because surveys are not necessarily conducted at the ideal time for sandwave building. Some research has shown that sandwave mobility is most evident in the vertical plane and high spots may occur on crest lines in response to calm weather, and possibly during particular times within the tidal cycle. It is therefore important to warn the mariner of the presence of sandwaves, and provide them with as much information as is available and can be included in the ENC.

If it is required to encode sandwaves, this must be done using the feature **Sandwave**.

Remarks:

- The shifting nature of the seabed resulting from sandwave activity should be indicated on the underlying **Quality of Bathymetric Data** (see clause X.X), using the attribute **category of temporal variation**.
- The attribute **vertical length** is used to populate the amplitude of the sandwave above the seafloor, where known.
- Care must be taken not to over-generalize depth depiction in sandwave areas, as the typically convoluted contour pattern, and significant depth changes between soundings selected from crests and troughs, help to draw attention to these features. However, this will not usually be sufficient warning, as the variance between crest and trough may fall between standard contours, or the maximum display scale for the ENC data may be insufficient to show the sandwaves individually, or anything but the shoalest soundings. Attention should therefore be drawn to the area by encoding a **Sandwave** feature. If considered necessary, the nature of any navigational hazard presented by the sandwaves may be incorporated using an associated instance of the information class **Nautical Information** (see clause X.X), complex attribute **information**.
- Where frequently repeated surveys show variations in least depth, the shoalest soundings obtained over a period of years should be encoded. This blending of details from surveys of differing dates must be done with care; in particular, long-term deepening must not be overlooked.

Distinction: Seabed area.

12.4 Springs in the seabed

IHO Definition: **SPRING.** A natural issue of water or other substances from the earth. One on the bottom of the sea is called a submarine spring. (IHO Dictionary – S-32).

S-101 Geo Feature: Spring (SPRING)

Primitives: Point

Real World

Paper Chart Symbol

ECDIS Symbol

S-101 Attribute	S-57 Acronym	Allowable Encoding Value	Type	Multiplicity
Feature name			C	0,*
Display name			(S) BO	0,1
Language		ISO 639-3	(S) TE	0,1
Name	(OBJNAM) (NOBJNM)		(S) TE	1,1
Scale minimum	(SCAMIN)	See clause X.X	IN	0,1

INT 1 Reference: J 15

12.4.1 Springs in the seabed (see S-4 – B-428.3)

Springs in the seabed may cause false echo-soundings. If it is required to encode a spring in the seabed, it must be done using the feature **Spring**.

Remarks:

- No remarks.

Distinction:

13 Geo Features – Rocks, Wrecks, Foul Ground, Obstructions

Full details of all dangers to navigation must be encoded except in those areas for which the ENC is clearly inappropriate for navigation. The fullest possible information on clearance depths must be given irrespective of their depths, in preference to making any arbitrary distinction between “dangerous” and “non-dangerous” depths. This will allow navigators of all classes of vessels, including deep-draught ships and submarines, to make their own assessments of what is dangerous to them.

Due to possible ECDIS display issues isolated dangers of type point (object classes **Underwater Rock, Wreck** and **Obstruction**) should be encoded as isolated nodes; that is, they should not be encoded on connected nodes.

13.1 Danger line limiting an area of wrecks or obstructions

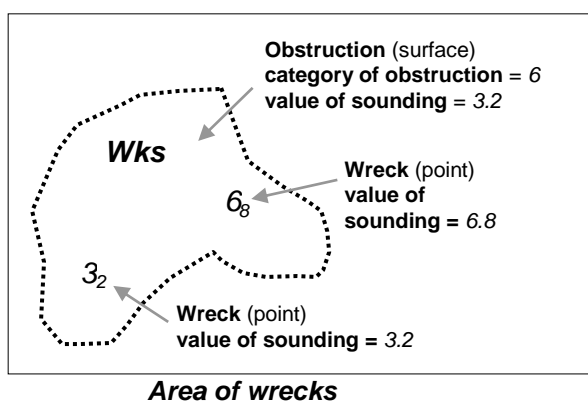

The area enclosed by the danger line must be encoded using **Wreck** (see clause X.X) or **Obstruction** (see clause X.X) features of type surface, with the attribute values, when encoded, reflecting the characteristics of the shallowest point feature encoded in the area. The area must also be covered by **Depth Area** or **Unsurveyed Area** features as appropriate.

If it is required to encode one or more least depths in such an area, it must be done using a point feature for each of the depths, in addition to the surface feature.

13.2 Danger line bordering an area through which navigation is not safe (see S-4 – B-420.1)

A danger line, bordering an area through which navigation is not safe, should be encoded using an **Obstruction** feature of type surface, with attribute **category of obstruction = 6** (foul area).

13.3 Doubtful dangers (see S-4 – B-424)

The fact that a danger is doubtful should be encoded using the feature attributes **quality of vertical measurement** and **status** and the spatial attribute **quality of horizontal measurement** for the feature:

	S-4	INT 1	quality of horizontal measurement	quality of vertical measurement	status
Position approximate	B-424.1	B7	4		
Position doubtful	B-424.2	B8	5		
Existence doubtful	B-424.3	I1			18
Doubtful sounding	B-424.4	I2		3	
Reported danger	B-424.5	I3.1, 3.2	7 or 8	8 or 9	

Remarks:

- The same notions of approximate or doubtful positions and doubtful existence also apply to features other than dangers (for example landmarks, buoys).
- The text "Discoloured water" on the source indicates the probable existence of shallow water. This must be encoded, where required, using a **Discoloured Water** feature (see clause X.X).

13.4 Rocks (intertidal/awash/submerged)

IHO Definition: UNDERWATER/AWASH ROCK. A concreted mass of stony material or coral which dries, is awash or is below the water surface. (S-57 Edition 3.1, Appendix A – Chapter 1, Page 1.194, November 2000).				
S-101 Geo Feature: Underwater/awash rock (UWTROC)				
Primitives: Point				
<i>Real World</i>		<i>Paper Chart Symbol</i>		<i>ECDIS Symbol</i>
S-101 Attribute	S-57 Acronym	Allowable Encoding Value	Type	Multiplicity
Exposition of sounding	(EXPSOU)	1 : within the range of depth of the surrounding depth area 2 : shoaler than the range of depth of the surrounding depth area	EN	0,1
Feature name			C	0,*
Display name			(S) BO	0,1
Language		ISO 639-3	(S) TE	0,1
Name	(OBJNAM) (NOBJNM)		(S) TE	1,1
Nature of surface	(NATSUR)	14 : coral	EN	0,1
Quality of vertical measurement	(QUASOU)	1 : depth known 2 : depth or least depth unknown 3 : doubtful sounding 4 : unreliable sounding 6 : least depth known 7 : least depth unknown, safe clearance at value shown 8 : value reported (not surveyed) 9 : value reported (not confirmed)	EN	0,*
Reported date	(SORDAT)	ISO 8601: 2004	TD	0,1
Status	(STATUS)	18 : existence doubtful	EN	0,1
Technique of vertical measurement	(TECSOU)	1 : found by echo-sounder 2 : found by side scan sonar 3 : found by multi-beam 4 : found by diver 5 : found by lead-line 6 : swept by wire-drag 8 : swept by vertical acoustic system 9 : found by electromagnetic sensor 10 : photogrammetry 11 : satellite imagery 12 : found by leveling 13 : swept by side-scan	EN	0,*

		sonar 15 : found by LIDAR		
Value of sounding	(VALSOU)		RE	1,1
Vertical uncertainty	(SOUACC)		C	0,1
Uncertainty fixed			(S) RE	1,1
Uncertainty variable			(S) RE	0.1
Water level effect	(WATLEV)	3 : always under water/ submerged 4 : covers and uncovers 5 : awash	EN	1,1
Scale minimum	(SCAMIN)	See clause X.X	IN	0,1
Default clearance depth			RE	0,1
Surrounding depth			RE	0,1

INT 1 Reference: K 11-15

13.4.1 Rocks which may cover (see S-4 – B-421.2 to B-421.4)

Full details of all dangers to navigation must be encoded except in those areas for which the ENC is clearly inappropriate for navigation (see S-4 – B-401 and B-402). The fullest possible information on clearance depths must be given irrespective of their depths, where known, in preference to making any arbitrary distinction between “dangerous” and “non-dangerous” depths. This will allow navigators of all classes of vessels, including deep-draught ships and submarines, to make their own assessments of what is dangerous to them.

Underwater rocks may cover and uncover, may be awash, or may be always underwater.

Population of the attributes **quality of vertical measurement**, **water level effect**, **reported date** and the spatial attribute **quality of horizontal measurement** are described in the Table below:

Rock or coral reef	INT 1	water level effect	quality of vertical measurement	Comment
Covers and uncovers, depth unknown	K11	4	2 or <undefined>	See Remarks below for population of the attribute exposition of sounding .
Covers and uncovers, depth known	K11	4	any value except 2; or <undefined>	Negative value for value of sounding
Awash	K12	5		
Always submerged, depth unknown	K13	3	2 or <undefined>	See Remarks below for population of the attribute exposition of sounding .
Always submerged, depth known	K14	3	any value except 2; or <undefined>	
Reported, not confirmed	I3.1,3.2	3,4 or 5	9	If available, the year reported should be encoded in reported date . The attribute quality of horizontal measurement should be set to 8 (reported, not confirmed).

Remarks:

- For rocks which do not cover (islets), see clause X.X.
- All **Underwater/Awash Rock** features should be encoded using one of the above combinations of attributes.

- For guidance regarding the population of the complex attribute **vertical uncertainty**, see clause **X.X (Quality of Bathymetric Data)**.
- A rock represented by a spot sounding and an associated nature of seabed (underwater rock not dangerous to surface navigation) should be encoded using a single **Underwater/Awash Rock** feature, with the sounding value encoded using the attribute **value of sounding**. Where **Underwater/Awash Rock** is encoded, there must be no **Sounding** feature encoded coincident.
- For area rock and coral reef features, see clause **X.X**.
- When a group of rocks is surrounded by a danger line, each rock should be encoded as a separate **Underwater/Awash Rock** feature covered by an obstruction area feature (**Obstruction** – see clause **X.X**).
- If it is required to encode an **Underwater/Awash Rock** feature where the attribute **value of sounding** is populated with an empty (null) value, but the source information indicates the depth of the feature is within the range of the surrounding depth area, the value **exposition of sounding = 1** (within the range of the surrounding depth area) must be populated in order to avoid the unnecessary display of isolated danger symbols in ECDIS.

Distinction: Obstruction; seabed area; sounding; wreck.

13.5 Wrecks

IHO Definition: **WRECK.** The ruined remains of a stranded or sunken vessel which has been rendered useless. (IHO Dictionary – S-32).

S-101 Geo Feature: Wreck (WRECKS)

Primitives: Point, Surface

Real World

Paper Chart Symbol

ECDIS Symbol

S-101 Attribute	S-57 Acronym	Allowable Encoding Value	Type	Multiplicity
Category of wreck	(CATWRK)	1 : non-dangerous wreck 2 : dangerous wreck 3 : distributed remains of wreck 4 : wreck showing mast/masts 5 : wreck showing any portion of hull or superstructure	EN	0,1
Exposition of sounding	(EXPSOU)	1 : within the range of depth of the surrounding depth area 2 : shoaler than the range of depth of the surrounding depth area 3 : deeper than the range of depth of the surrounding depth area	EN	0,1
Feature name			C	0,*
Display name			(S) BO	0,1
Language		ISO 639-3	(S) TE	0,1
Name	(OBJNAM) (NOBJNM)		(S) TE	1,1
Height	(HEIGHT)		RE	0,1
Quality of vertical measurement	(QUASOU)	1 : depth known 2 : depth or least depth unknown 3 : doubtful sounding 4 : unreliable sounding 6 : least depth known 7 : least depth unknown, safe clearance at value shown 8 : value reported (not surveyed) 9 : value reported (not confirmed)	EN	0,*
Radar conspicuous	(CONRAD)		BO	0,1
Reported date	(SORDAT)	ISO 8601: 2004	TD	0,1
Status	(STATUS)	7 : temporary 13 : historic	EN	0,*

		18 : existence doubtful		
Technique of vertical measurement	(TECSOU)	1 : found by echo-sounder 2 : found by side scan sonar 3 : found by multi-beam 4 : found by diver 5 : found by lead-line 6 : swept by wire-drag 8 : swept by vertical acoustic system 9 : found by electromagnetic sensor 10 : photogrammetry 11 : satellite imagery 12 : found by levelling 13 : swept by side-scan sonar 15 : found by LIDAR	EN	0,*
Value of sounding	(VALSOU)		RE	0,1
Vertical uncertainty	(SOUACC)		C	0,1
Uncertainty fixed			(S) RE	1,1
Uncertainty variable			(S) RE	0.1
Visually conspicuous	(CONVIS)	1 : visually conspicuous 2 : not visually conspicuous 3 : prominent	EN	0,1
Water level effect	(WATLEV)	1 : partly submerged at high water 2 : always dry 3 : always under water/ submerged 4 : covers and uncovers 5 : awash	EN	1,1
Scale minimum	(SCAMIN)	See clause X.X	IN	0,1
Default clearance depth			RE	0,1
Surrounding depth			RE	0,1

INT 1 Reference: K 20-31

13.5.1 Wrecks (see S-4 – B-422, B-422.1 to B-422.8)

Wrecks must be encoded to whatever depth they are considered to be of interest, also taking account of the needs of submarines and fishing vessels where appropriate, but not generally in water deeper than 2000m. (Trawling regularly takes place in depths of 400m and occasionally in depths as great as 2000m).

Population of the attributes **category of wreck**, **quality of vertical measurement**, **technique of vertical measurement** and **water level effect** are described in the Table below.

In the following table, the symbol '/' indicates that this attribute is not relevant for the wreck instance and therefore must not be encoded. A blank indicates that the encoder may choose a relevant value for the attribute.

Wrecks...	S-4	INT 1	category of wreck	water level effect	quality of vertical measurement	technique of vertical measurement
Showing any part of hull or superstructure	B-422.2	K24 K20	5	1,2 or 4	/	/
Covers and uncovers	B-422.2	K24 K21	4 or 5	4		
Awash				5		

Only the mast is visible at high water	B-422.2	K25	4 or 5	2	/	/
Only the mast is visible at low water	B-422.2	K25	4	4		
Measured depth	B-422.4	K26		3	1, 6 or <undefined>	
Depth measured and swept by wire drag	B-422.3	K27		3	6	6
Depth measured by diver	B-422.3	K27		3	1 or 6	4
Depth unknown, considered dangerous by the responsible producing authority	B-422.6	K28	2	3	2* or <undefined>	/
Depth unknown, not considered dangerous by the responsible producing authority	B-422.6	K29	1	3	2* or <undefined>	/
Depth unknown, with a safe clearance	B-422.5	K30		3	7	/
Distributed remains of wreck	B-422.8	K31	3			
Reported, not confirmed	B-424.5	I3.1 I3.2			9	

All wrecks should be encoded using one of the above combinations of attributes.

* For a wreck where the least depth is unknown, the attribute value 2 (depth or least depth unknown) for **quality of vertical measurement** does not apply to the depth of the seabed near the wreck.

The provision of more quantitative information for wrecks where possible is particularly important in terms of the portrayal of wrecks in ECDIS. This often results in wrecks being symbolised as an obstruction to navigation where they are actually non-dangerous. Where the depth of the wreck is unknown, compilers should consider determining an estimated safe clearance value (see S-4 – B-422.5) and populating **quality of vertical measurement** = 7 (least depth unknown, safe clearance at value shown).

Remarks:

- At least one of the attributes **category of wreck** or **value of vertical measurement** must be populated.
- The attribute **height** is only relevant for wrecks having attribute **water level effect** = 1 (partly submerged at high water) or 2 (always dry).
- For guidance regarding the population of the complex attribute **vertical uncertainty**, see clause **X.X (Quality of Bathymetric Data)**.
- For reported, not confirmed wrecks, the date of the report must be populated, where known, using the attribute **reported date**.
- The distributed remains of a wreck must be encoded, where required, as a **Wrecks** feature with attribute **category of wreck** = 3 (distributed remains of wreck). Even though the wreck may be safe for surface vessels to navigate over the wreck, it must not be encoded as foul ground (see clause **X.X**).
- When encoding a **Wreck** feature, the attributes populated should adhere to the guidance in S-4 Clause B-422. Where possible, this includes the population of the attributes **value of sounding** and **quality of vertical measurement** where the depth of a wreck is known, or the depth is unknown but an estimated safe clearance can be determined. Where the depth is known, or the depth is unknown but an estimated safe clearance has been determined, it is not required to populate the attribute **category of wreck** = 1 (non-dangerous wreck) or 2 (dangerous wreck), as the mariner has the quantitative information in order to determine whether the wreck may be dangerous to their type of vessel.
- If it is required to encode a **Wreck** feature where the attribute **value of sounding** is not populated or is populated with an empty (null) value, but the source information indicates the depth of the feature is within the range of the surrounding depth area, the value **exposition of sounding** = 1 (within the range of the surrounding depth area) must be populated in order to avoid the unnecessary display of isolated danger symbols in ECDIS.
- For wrecks visible or partly visible at sounding datum, the height or drying height should be encoded, if known. This helps to distinguish wrecks which are always visible from wrecks which are only visible at low tide.

13.5.1.1 Where a wreck is shown with its true shape (large scale ENCs) (see S-4 – B-422.1)

Soundings and heights are often given inside a wreck to show the highest points of the hull or superstructure (for example mast, funnel). If it is required to encode such features, they must be done using:

- A **Wreck** feature of type surface with all populated attributes applying to the highest point of the wreck.
- **Land Elevation** features of type point to encode the features of the wreck that are always dry; the type of each feature (for example mast, funnel) may be encoded using an associated instance of the information class **Nautical Information** (see clause X.X), complex attribute **information**.
- **Sounding** features to encode the features of wrecks which are always submerged, or cover and uncover; the type of each feature (for example mast, funnel) may be encoded using an associated instance of the information class **Nautical Information** (see clause X.X), complex attribute **information**, which means that these soundings must be encoded individually.

13.5.1.2 Changing criteria for wrecks

Historically the criteria used for differentiating between “dangerous” and “non-dangerous” wrecks were often based on a threshold value for the estimated depth over the wreck (for example 20m, 28m). Criteria have varied between nations and over time (due to the increasing draught of large vessels). The term “non-dangerous wreck” may be applied even though a wreck may be dangerous to some vessels capable of navigating in the vicinity. Unfortunately, the mariner is not necessarily aware of that fact or that, due to the changing criteria, wrecks encoded as “non-dangerous” may have different meanings. Ideally, therefore, all encoded “dangerous” and “non-dangerous” wrecks having no known depth should be re-assessed to conform to the guidance provided in S-4 – B-422.

13.5.2 Historic wrecks (see S-4 – B-449.5)

Many nations have designated areas around certain wrecks of historical or cultural (for example sea graves) importance to protect the wrecks from unauthorised interference (for example by diving, salvage or anchoring). Such areas should be encoded on the largest maximum display scale ENC data covering the wreck.

If it is required to encode a restricted area around a historic wreck, it must be done using a **Restricted Area Navigational** feature (see clause X.X) or **Restricted Area Regulatory** feature (see clause X.X), with attribute **category of restricted area** = 10 (historic wreck area).

In addition, the wreck itself should be encoded as a **Wreck** feature, with attribute **status** = 13 (historic).

Distinction: Depth area; hulk; obstruction; sounding; underwater/awash rock.

13.6 Obstructions

IHO Definition: OBSTRUCTION. In marine navigation, anything that hinders or prevents movement, particularly anything that endangers or prevents passage of a vessel. The term is usually used to refer to an isolated danger to navigation, such as a sunken rock or pinnacle. (IHO Dictionary – S-32).

S-101 Geo Feature: Obstruction (OBSTRN)

Primitives: Point, Curve, Surface

Real World

Paper Chart Symbol

ECDIS Symbol

S-101 Attribute	S-57 Acronym	Allowable Encoding Value	Type	Multiplicity
Category of obstruction	(CATOBS)	1 : snag/stump 2 : wellhead 3 : diffuser 4 : crib 5 : fish haven 6 : foul area 8 : ice boom 9 : ground tackle 10 : boom 12 : wave energy device 13 : subsurface ocean data acquisition system (ODAS) 14 : artificial reef 15 : template 16 : manifold 17 : submerged pingo 18 : remains of platform 19 : scientific instrument 20 : underwater turbine	EN	0,1
Condition	(CONDTN)	1 : under construction 2 : ruined 5 : planned construction	EN	0,1
Exposition of sounding	(EXPSOU)	1 : within the range of depth of the surrounding depth area 2 : shoaler than the range of depth of the surrounding depth area 3 : deeper than the range of depth of the surrounding depth area	EN	0,1
Feature name			C	0,*
Display name			(S) BO	0,1
Language		ISO 639-3	(S) TE	0,1
Name	(OBJNAM) (NOBJNM)		(S) TE	1,1
Height	(HEIGHT)		RE	0,1
Maximum permitted draught			RE	0,1
Product	(PRODCT)	1 : oil 2 : gas	EN	0,*

		3 : water 8 : drinking water 23 : electricity		
Quality of vertical measurement	(QUASOU)	1 : depth known 2 : depth or least depth unknown 3 : doubtful sounding 4 : unreliable sounding 6 : least depth known 7 : least depth unknown, safe clearance at value shown 8 : value reported (not surveyed) 9 : value reported (not confirmed)	EN	0,*
Reported date	(SORDAT)	ISO 8601: 2004	TD	0,1
Status	(STATUS)	1 : permanent 4 : not in use 5 : periodic/intermittent 7 : temporary 8 : private 13 : historic 18 : existence doubtful 28 : buoyed	EN	0,*
Nature of surface	(NATSUR)	1 : mud 2 : clay 3 : silt 4 : sand 5 : stone 6 : gravel 7 : pebbles 8 : cobbles 9 : rock 11 : lava 14 : coral 17 : shells 18 : boulder	EN	0,*
Technique of vertical measurement	(TECSOU)	1 : found by echo-sounder 2 : found by side scan sonar 3 : found by multi-beam 4 : found by diver 5 : found by lead-line 6 : swept by wire-drag 8 : swept by vertical acoustic system 9 : found by electromagnetic sensor 10 : photogrammetry 11 : satellite imagery 12 : found by levelling 13 : swept by side-scan sonar 15 : found by LIDAR	EN	0,*
Value of sounding	(VALSOU)		RE	0,1
Vertical length	(VERLEN)		RE	0,1
Vertical uncertainty	(SOUACC)		C	0,1
Uncertainty fixed			(S) RE	1,1
Uncertainty variable			(S) RE	0.1
Water level effect	(WATLEV)	1 : partly submerged at high	EN	1,1

		water 2 : always dry 3 : always under water/ submerged 4 : covers and uncovers 5 : awash 7 : floating		
Scale minimum	(SCAMIN)	See clause X.X	IN	0,1
Default clearance depth			RE	0,1
Surrounding depth			RE	0,1

INT 1 Reference: K 1, 31, 40-43, 46; L 21, 23; Q 42

13.6.1 Obstructions and foul areas (see S-4 – B-327.5, B-420.1, B-422.8-9, B-431.6, B-445.1 and B-447.5, B-447.7)

If it is required to encode snags, stumps, wellheads, diffusers, cribs, fish havens, foul areas, booms, ice booms, sites of cleared platforms, ground tackle, wave energy devices, underwater turbines, subsurface ocean data acquisition systems, or artificial reefs, it must be done using the feature **Obstruction**.

Population of the attributes **quality of vertical measurement**, **technique of vertical measurement** and **water level effect** are described in the Table below.

In the following table, the symbol '/' indicates that this attribute is not relevant for the obstruction instance and therefore must not be encoded. A blank indicates that the encoder may choose a relevant value for the attribute.

Obstruction...	INT 1	water level effect	quality of vertical measurement	technique of vertical measurement
Depth unknown	K40	3 or 4	2* or <undefined>	/
Least depth known	K41	3 or 4	1 or 6	
Swept by wire to the depth shown	K42	3	6	6
Measured by diver	K42	3	1 or 6	4

All obstructions should be encoded using one of the above combinations of attributes.

* For an obstruction where the least depth is unknown, the attribute value 2 (depth or least depth unknown) for **quality of vertical measurement** does not apply to the depth of the seabed near the obstruction.

It is important when encoding obstructions to be aware of the distinction between attribute value **category of obstruction** = 6 (foul area) and foul ground:

Foul areas are defined as areas of numerous uncharted dangers to navigation. When encoded on ENC, **Obstruction** features of type surface with attribute **category of obstruction** = 6 (foul area) will display in the ECDIS "base display" as an obstruction to navigation, with all associated alarms to indicate that it is unsafe for vessels to enter or transit the area.

Foul ground is defined as an area over which it is safe to navigate but which should be avoided for anchoring, taking the ground or ground fishing. When encoded on ENC, **Foul Ground** features (see clause X.X) of type surface will display in the ECDIS "other" display as a "foul area of seabed safe for navigation but not for anchoring", indicating to the mariner that it is safe to enter or transit the area but hazardous to take the ground or undertake other subsurface activities.

In some cases areas on the source indicated to be foul ground have been misinterpreted as foul areas, which has resulted in encoding in ENC of **Obstruction** with **category of obstruction** = 6 (foul area). This encoding results in the incorrect indication in the ECDIS that the area is unsafe for navigation, which is potentially confusing to the mariner.

Foul ground, over which it is safe to navigate but which should be avoided for anchoring, taking the ground or ground fishing, should be encoded using a **Foul Ground** feature. Although the source may depict a "Foul Area", it should be determined whether it is in fact "Foul Ground" before encoding the appropriate feature.

Remarks:

- The minimum depth, if known, over any obstruction, must be encoded using the attribute **value of sounding**. Where obstructions such as fish havens have a declared maximum authorised draught for vessels passing over the feature, this must be populated, where known, using the attribute **maximum permitted draught**.
- The attribute **height** must be populated for **Obstruction** features having attribute **water level effect** = 1 (partly submerged at high water) or 2 (always dry).
- The attribute **vertical length** is used to populate the distance of the obstruction above the seabed.
- For guidance regarding the population of the complex attribute **vertical uncertainty**, see clause **X.X (Quality of Bathymetric Data)**.
- For reported, not confirmed obstructions, the date of the report must be populated, where known, using the attribute **reported date**.
- If the nature of a dangerous underwater feature, dangerous underwater area, or floating feature is not explicitly known, it must be encoded using **Obstruction**.
- An **Obstruction** feature of type surface must be covered by a surface feature from Skin of the Earth as appropriate.
- An area containing numerous dangers, through which navigation is not safe at the maximum display scale for the ENC data, should be encoded using an **Obstruction** feature of type surface, with attribute **category of obstruction** = 6 (foul area).
- If it is required to encode an **Obstruction** feature where the attribute **value of sounding** is populated with an empty (null) value, but the source information indicates the depth of the feature is within the range of the surrounding depth area, the value **exposition of sounding** = 1 (within the range of the surrounding depth area) must be populated in order to avoid the unnecessary display of isolated danger symbols in ECDIS.
- A danger circle on a paper chart that surrounds a single symbol or sounding (for example INT1 – K26, K27, K40(b) or K41 to K43.1) must not be encoded as a separate surface. However, when a danger line indicates the true shape of the feature, it should be encoded using **Wreck** or **Obstruction** features of type surface. A single sounding enclosed by a danger circle on medium and large scale paper charts must be encoded using an **Obstruction** feature of type point. The sounding value, in this case, must be encoded using the attribute **value of sounding**. Soundings enclosed by a danger circle on small scale paper charts may indicate a reported, not confirmed sounding, and such soundings should be evaluated to determine whether they should be encoded as **Obstruction** features, or **Sounding** features (see clause **X.X**) with attribute QUAOU = 9 (value reported (not confirmed)).
- Platforms which have been cut-off above the seabed must be encoded as **Obstruction**, while platforms which have been cut-off to the level of the seabed should be encoded as **Foul Ground** (see clause **X,X**).
- In certain circumstances where an obstruction is always dry (for example cribs), it must be covered by a **Land Area** feature.
- Features that are considered to be subsurface Fish Aggregating Devices (FAD) must be encoded as **Obstruction**, with **category of obstruction** = 5 (fish haven), unless the FAD is a vessel that has been deliberately sunk to form a fish haven, which should be encoded as a **Wreck** feature (see clause **X,X**).
- If it is required to encode a subsurface ocean data acquisition systems (ODAS), whether on the seabed or suspended in the water column by a subsurface float, it must be done using **Obstruction** with **category of obstruction** = 14 (subsurface ocean data acquisition system (ODAS)). An ODAS buoy must be encoded as a **Buoy Special Purpose/General** feature (see clause **X.X**).

Distinction: Depth area; fishing facility; foul ground; marine farm/culture; underwater/awash rock; water turbulence; wreck.

13.7 Foul ground

IHO Definition: FOUL GROUND. Areas over which it is safe to navigate but which should be avoided for anchoring, taking the ground or ground fishing. (IHO Dictionary – S-32).				
S-101 Geo Feature: Foul ground (<i>OBSTRN</i>)				
Primitives: Point, Curve, Surface				
<i>Real World</i>		<i>Paper Chart Symbol</i>		<i>ECDIS Symbol</i>
S-101 Attribute	S-57 Acronym	Allowable Encoding Value	Type	Multiplicity
Feature name			C	0,*
Display name			(S) BO	0,1
Language		ISO 639-3	(S) TE	0,1
Name	(<i>OBJNAM</i>) (<i>NOBJNM</i>)		(S) TE	1,1
Quality of vertical measurement	(<i>QUASOU</i>)	1 : depth known 2 : depth or least depth unknown 3 : doubtful sounding 4 : unreliable sounding 6 : least depth known 7 : least depth unknown, safe clearance at value shown 8 : value reported (not surveyed) 9 : value reported (not confirmed)	EN	0,*
Reported date	(<i>SORDAT</i>)	ISO 8601: 2004	TD	0,1
Status	(<i>STATUS</i>)	13 : historic 18 : existence doubtful 28 : buoyed	EN	0,*
Technique of vertical measurement	(<i>TECSOU</i>)	1 : found by echo-sounder 2 : found by side scan sonar 3 : found by multi-beam 4 : found by diver 5 : found by lead-line 6 : swept by wire-drag 8 : swept by vertical acoustic system 9 : found by electromagnetic sensor 10 : photogrammetry 11 : satellite imagery 12 : found by levelling 13 : swept by side-scan sonar 15 : found by LIDAR	EN	0,*
Value of sounding	(<i>VALSOU</i>)		RE	0,1
Vertical uncertainty	(<i>SOUACC</i>)		C	0,1
Uncertainty fixed			(S) RE	1,1

Uncertainty variable			(S) RE	0.1
Water level effect	(WATLEV)	3 : always under water / submerged 4 : covers and uncovers 5 : awash	EN	0,1
Scale minimum	(SCAMIN)	See clause X.X	IN	0,1

INT 1 Reference:

13.7.1 Foul ground (see S-4 – B-422.8)

If it is required to encode an area over which it is safe to navigate for surface vessels, but where seabed operations are unsafe, it must be done using the feature **Foul Ground**. Such areas are distinct from the feature **Obstruction**, attribute **category of obstruction** = 6 (foul area), where navigation is considered to be unsafe for surface vessels.

Population of the attributes **quality of vertical measurement** and **technique of vertical measurement** are described in the Table below.

In the following table, the symbol '/' indicates that this attribute is not relevant for the foul ground instance and therefore must not be encoded. A blank indicates that the encoder may choose a relevant value for the attribute.

Foul Ground...	INT 1	water level effect	quality of vertical measurement	technique of vertical measurement
Depth unknown	K40	3 or 4	2* or <undefined>	/
Least depth known	K41	3 or 4	1 or 6	
Swept by wire to the depth shown	K42	3	6	6
Measured by diver	K42	3	1 or 6	4

All foul ground should be encoded using one of the above combinations of attributes.

* For foul ground where the least depth is unknown, the attribute value 2 (depth or least depth unknown) for **quality of vertical measurement** does not apply to the depth of the seabed near the foul ground.

Remarks:

- The minimum depth, if known, over any foul ground, must be encoded using the attribute **value of sounding**.
- For guidance regarding the population of the complex attribute **vertical uncertainty**, see clause X.X (**Quality of Bathymetric Data**).
- For reported, not confirmed foul ground, the date of the report must be populated, where known, using the attribute **reported date**.
- A **Foul Ground** feature of type surface must be covered by a surface feature from Skin of the Earth as appropriate.
- Platforms which have been cut-off to the level of the seabed should be encoded as **Foul Ground**, while platforms which have been cut-off above the seabed must be encoded as **Obstruction** (see clause X,X).
- The distributed remains of wrecks must be encoded using the feature **Wreck** (see clause X.X), and must not be encoded as **Foul Ground**.

Distinction: Depth area; fishing facility; marine farm/culture; obstruction; seabed area; underwater/awash rock; water turbulence; wreck.

13.8 Discoloured water

IHO Definition: **DISCOLOURED WATER.** Unnatural coloured areas in the sea which may or may not indicate the existence of shoals. (NOAA – Nautical Chart Manual, Volume 1).

S-101 Geo Feature: Discoloured water

Primitives: Point, Surface

Real World

Paper Chart Symbol

ECDIS Symbol

S-101 Attribute	S-57 Acronym	Allowable Encoding Value	Type	Multiplicity
Reported date	(SORDAT)	ISO 8601: 2004	TD	0,1
Scale minimum	(SCAMIN)	See clause X.X	IN	0,1

INT 1 Reference:

13.8.1 Discoloured water (see S-4 – B-424.6)

If it is required to encode the possible existence of shoal water as indicated by an area of discoloured water, it must be done using the feature **Discoloured Water**.

Remarks:

- The feature **Discoloured Water** must only be used to indicate an area of possible shoal water where an observation of the discolouration has been made and there is no supporting bathymetric data to support the possible shoaling.
- A **Discoloured Water** feature must be covered by **Depth Area** or **Unsurveyed Area** features.

Distinction: Caution area; obstruction; underwater/awash rock; wreck.

13.9 Fishing facility

IHO Definition: **FISHING FACILITY.** A structure for fishing purposes which can be an obstruction to ships in general. The position of these structures may vary frequently over time. (S-57 Edition 3.1, Appendix A – Chapter 1, Page 1.70, November 2000, as amended).

S-101 Geo Feature: Fishing facility (FSHFAC)

Primitives: Point, Curve, Surface

<i>Real World</i>	<i>Paper Chart Symbol</i>	<i>ECDIS Symbol</i>
-------------------	---------------------------	---------------------

S-101 Attribute	S-57 Acronym	Allowable Encoding Value	Type	Multiplicity
Category of fishing facility	(CATFIF)	1 : fishing stake 2 : fish trap 3 : fish weir 4 : tunny net	EN	0,1
Condition	(CONDTN)	1 : under construction 2 : ruined 5 : planned construction	EN	0,1
Feature name			C	0,*
Display name			(S) BO	0,1
Language		ISO 639-3	(S) TE	0,1
Name	(OBJNAM) (NOBJNM)		(S) TE	1,1
Periodic date range			C	0,*
Date end	(PEREND)	ISO 8601: 2004	(S) TD	1,1
Date start	(PERSTA)	ISO 8601: 2004	(S) TD	1,1
Reported date	(SORDAT)	ISO 8601: 2004	TD	0,1
Status	(STATUS)	1 : permanent 4 : not in use 5 : periodic/intermittent 6 : reserved 7 : temporary 8 : private 12 : illuminated 18 : existence doubtful 28 : buoyed	EN	0,*
Vertical length	(VERLEN)		RE	0,1
Scale minimum	(SCAMIN)	See clause X.X	IN	0,1

INT 1 Reference: K 44, 45

13.9.1 Fishing facilities (see S-4 – B-447 and B-447.1-3)

Fishing facilities are usually sited in shallow water, but tunny nets are often located in deeper water. They can be very large and extend up to several miles offshore; and form an obstruction to navigation.

If it is required to encode a fishing facility it must be done using the feature **Fishing Facility**.

Remarks:

- The attribute **vertical length** is used to populate the distance of the facility above the seabed.
- Floating fish aggregating devices (FAD) must be encoded, where required, as **Buoy Special**

Purpose/General features (see clause X.X). Subsurface FADs (fish havens) must be encoded, where required, as **Obstruction** features (see clause X.X).

Distinction: Marine farm/culture; obstruction.

Feature/Information associations							
Type	Association Name	Association Ends					
		Class	Role	Mult	Class	Role	Mult
Comp	Structure/Equipment	Fishing Facility	Supported by	0,1	Daymark, Fog Signal, Light Air Obstruction, Light All Around, Light Fog Detector, Light Sector, Physical AIS Aid to Navigation, Radar Reflector, Radar Transponder Beacon, Retroreflector, Signal Station Traffic, Signal Station Warning	Supports	1,*

13.10 Marine farm/culture

IHO Definition: MARINE FARM/CULTURE. An assemblage of cages, nets, rafts and floats or posts where fish, including shellfish, are artificially cultivated. Also called fish farm. (IHO Dictionary – S-32).				
S-101 Geo Feature: Marine farm/culture (MARCUL)				
Primitives: Point, Curve, Surface				
<i>Real World</i>		<i>Paper Chart Symbol</i>		<i>ECDIS Symbol</i>
S-101 Attribute	S-57 Acronym	Allowable Encoding Value	Type	Multiplicity
Category of marine farm/culture	(CATMFA)	1 : crustaceans 2 : edible bivalve molluscs 3 : fish 4 : seaweed 5 : pearl culture farm	EN	0,1
Exposition of sounding	(EXPSOU)	1 : within the range of depth of the surrounding depth area 2 : shoaler than the range of depth of the surrounding depth area	EN	0,1
Feature name			C	0,*
Display name			(S) BO	0,1
Language		ISO 639-3	(S) TE	0,1
Name	(OBJNAM) (NOBJNM)		(S) TE	1,1
Fixed date range			C	0,1
Date end	(DATEND)	ISO 8601: 2004	(S) TD	0,1
Date start	(DATSTA)	ISO 8601: 2004	(S) TD	0,1
Periodic date range			C	0,*
Date end	(PEREND)	ISO 8601: 2004	(S) TD	1,1
Date start	(PERSTA)	ISO 8601: 2004	(S) TD	1,1
Quality of vertical measurement	(QUASOU)	1 : depth known 2 : depth or least depth unknown 3 : doubtful sounding 4 : unreliable sounding 6 : least depth known 7 : least depth unknown, safe clearance at value shown 8 : value reported (not surveyed) 9 : value reported (not confirmed)	EN	0,*
Restriction	(RESTRN)	1 : anchoring prohibited 2 : anchoring restricted 3 : fishing prohibited 4 : fishing restricted 5 : trawling prohibited	EN	0,*

		6 : trawling restricted 7 : entry prohibited 8 : entry restricted 9 : dredging prohibited 10 : dredging restricted 11 : diving prohibited 12 : diving restricted 13 : no wake 14 : area to be avoided 15 : construction prohibited 16 : discharging prohibited 17 : discharging restricted 18 : industrial or mineral exploration/development prohibited 19 : industrial or mineral exploration/development restricted 20 : drilling prohibited 21 : drilling restricted 22 : removal of historical artefacts prohibited 23 : cargo transshipment (lightening) prohibited 24 : dragging prohibited 25 : stopping prohibited 26 : landing prohibited 27 : speed restricted 39 : swimming prohibited		
Status	(STATUS)	1 : permanent 2 : occasional 4 : not in use 5 : periodic/intermittent 6 : reserved 7 : temporary 8 : private 14 : public 16 : watched 17 : un-watched 28 : buoyed	EN	0,*
Value of sounding	(VALSOU)		RE	0,1
Vertical length	(VERLEN)		RE	0,1
Vertical uncertainty	(SOUACC)		C	0,1
Uncertainty fixed			(S) RE	1,1
Uncertainty variable			(S) RE	0.1
Water level effect	(WATLEV)	1 : partly submerged at high water 2 : always dry 3 : always under water/submerged 4 : covers and uncovers 5 : awash 7 : floating	EN	1,1
Scale minimum	(SCAMIN)	See clause X.X	IN	0,1

INT 1 Reference: K 47, 48

13.10.1 Marine farms (see S-4 – B- 447.4 and B-447.6)

Marine farms are collections of cages, nets, rafts and floats, or posts, where fish, including shellfish, are reared. They may obstruct navigation, and are likely to be marked by buoys and possibly lights. They are not always confined to inshore locations. Shellfish beds are found in shallow water. Depending on vessel draught

and tidal range, it is usually possible to navigate over them, at high water, but they can be damaged by vessels anchoring or grounding on them.

If it is required to encode a marine farm, it must be done using the feature **Marine Farm/Culture**.

Remarks:

- When it is required to encode the minimum depth of the feature, the attributes **exposition of sounding** and **quality of vertical measurement** and the mandatory attribute **value of sounding** must be used. When a **Marine Farm/Culture** feature covers an area of the seafloor at the maximum display scale of the data, the value of the attribute **value of sounding** represents the minimum depth, if known, over any structure used to form or support the marine farm, or within the area of the marine farm itself. The mandatory attribute **water level effect** must be used to encode the water level of the shallowest section of the area, if partly or completely under water.
- The attribute **height** must be populated for **Marine Farm/Culture** features having attribute **water level effect** = 1 (partly submerged at high water) or 2 (always dry).
- The attribute **vertical length** is used to populate the distance of the marine farm above the seabed.
- Where required, ground tackle associated with marine farms must be encoded as **Obstruction** features (see clause X.X).

13.10.2 Fish havens (see S-4 – B- 447.5)

If it is required to encode a fish haven, it must be done using an **Obstruction** feature (see clause X.X), with attribute **category of obstruction** = 5 (fish haven).

Distinction: Fishing facility; obstruction.

14 Geo Features – Offshore Installations

14.1 Offshore platform

IHO Definition: **OFFSHORE PLATFORM.** A permanent offshore structure, either fixed or floating. (Adapted from IHO Dictionary – S-32).

S-101 Geo Feature: Offshore platform (OFSPFL)

Primitives: Point, Surface

Real World

Paper Chart Symbol

ECDIS Symbol

S-101 Attribute	S-57 Acronym	Allowable Encoding Value	Type	Multiplicity
Category of offshore platform	(CATOFP)	1 : oil derrick/rig 2 : production platform 3 : observation/research platform 4 : articulated loading platform (ALP) 5 : single anchor leg mooring (SALM) 6 : mooring tower 7 : artificial island 8 : floating production, storage and off-loading vessel (FPSO) 9 : accommodation platform 10 : navigation, communication and control buoy (NCCB) 11 : floating oil tank	EN	0,1
Colour	(COLOUR)	1 : white 2 : black 3 : red 4 : green 5 : blue 6 : yellow 7 : grey 8 : brown 9 : amber 10 : violet 11 : orange 12 : magenta 13 : pink	EN	0,* (ordered)
Colour pattern	(COLPAT)	1 : horizontal stripes 2 : vertical stripes 3 : diagonal stripes 4 : squared 5 : stripes (direction unknown) 6 : border stripe	EN	0,1
Condition	(CONDTN)	1 : under construction 2 : ruined 5 : planned construction	EN	0,1
Feature name			C	0,*

Display name			(S) BO	0,1
Language		ISO 639-3	(S) TE	0,1
Name	(OBJNAM) (NOBJNM)		(S) TE	1,1
Fixed date range			C	0,1
Date end	(DATEND)	ISO 8601: 2004	(S) TD	0,1
Date start	(DATSTA)	ISO 8601: 2004	(S) TD	0,1
Flare stack	(LNDMRK)		BO	0,1
Height	(HEIGHT)		RE	0,1
Product	(PRODCT)	1 : oil 2 : gas 3 : water 18 : liquefied natural gas (LNG) 19 : liquefied petroleum gas (LPG) 23 : electricity	EN	0,*
Radar conspicuous	(CONRAD)		BO	0,1
Reported date	(SORDAT)	ISO 8601: 2004	TD	0,1
Status	(STATUS)	1 : permanent 2 : occasional 4 : not in use 7 : temporary 8 : private 12 : illuminated 28 : buoyed	EN	0,*
Vertical length	(VERLEN)		RE	0,1
Visually conspicuous	(CONVIS)	1 : visually conspicuous 2 : not visually conspicuous 3 : prominent	EN	0,1
Water level effect	(WATLEV)	2 : always dry 7 : floating	EN	1,1
Scale minimum	(SCAMIN)	See clause X.X	IN	0,1

INT 1 Reference: L 2, 10-15, 17

14.1.1 Offshore platforms (see S-4 – B-445.2; B-445.4 and B-445.5)

Several different types of platforms are in use. They are normally piled steel or concrete structures, the latter held in position on the sea floor by gravity. Tension Leg Platforms (TLP) consist of semi-submersible platforms secured to flooded caissons on the sea floor vertically below them by wires kept in tension by the buoyancy of the platform.

Platforms may serve a number of purposes. They may carry any of the following equipment: drilling and production equipment; oil and gas separation and treatment plants; pump-line stations; and electricity generators. They may be fitted with cranes, a helicopter landing deck, and accommodation for up to 350 people. Platforms may stand singly or in groups connected by pipelines. Some stand close together in a complex, with bridges and underwater cables connecting them. Unwanted gas or oil is sometimes burnt from a flaring boom extending from the platform or from a nearby flare stack.

If it is required to encode a permanent offshore platform, it must be done using the feature **Offshore Platform**.

Remarks:

- The attribute **height** is only relevant for fixed platforms, and is referred to the vertical datum (see clause X.X).
- The attribute **vertical length** is only relevant for floating platforms, and is referred to the sea level.
- If it is required to encode sites of dismantled platforms, this must be done using **Foul Ground** features (see

clause X.X), unless the source indicates that any remaining structure protrudes far enough above the seabed so as to be an obstruction to surface navigation, in which case this must be encoded using an **Obstruction** feature (see clause X.X).

- Platforms may carry lights (see clause X.X), fog signals (see clause X.X), helicopter landing pads (see clause X.X) and flare stacks. Where fitted, lights should be encoded as described in clauses X.X to X.X, with the **Offshore Platform** being used as the structure feature for the light equipment feature(s). If it is required to encode the flare stack, it must be done by populating the Boolean attribute **flare stack** = *True* on the **Offshore Platform**.

14.1.2 Wellheads (see S-4 – B-445.1)

In the course of developing an oil or gas field, numerous wells may be drilled. Some, which will not be required again, may be sealed at or below the sea floor and abandoned; such wells must not be encoded, as they have no relevance to navigation.

A submerged wellhead is a submarine structure projecting some distance above the sea floor and capping a temporarily abandoned (or “suspended”) oil or gas well. Their associated pipes and other equipment usually project some 2 - 6 metres, but in some cases as much as 15 metres, above the sea floor. Some may be covered by steel cages to avoid snagging trawling gear. In certain instances, a wellhead may project above the sea surface. Wellheads must be encoded on at least the largest maximum display scale ENC data, together with associated buoys, as a hazard to fishing and, dependent on depth, as a hazard to deep-draught vessels and towed structures.

If it is required to encode wellheads, this must be done using **Obstruction** features of type point (see clause X.X), with attributes:

category of obstruction	- 2 - wellhead
height	
status	- 4 - not in use (disused)
value of sounding	
vertical length	- vertical length of the wellhead above the seabed
water level effect	- 2 - always dry (for wellheads that protrude at high water) 3 - always under water/submerged

14.1.3 Offshore safety zones (see S-4 – B-445.6)

Under UNCLOS, a coastal State may establish safety zones around artificial islands, installations and structures in their EEZ and on their continental shelf. These installations include drilling rigs, production platforms, wellheads, moorings and other associated structures. Safety zones normally extend 500 metres from the outermost points of the installations. Within these zones, appropriate measures can be taken to ensure the safety of navigation and of the installations.

If it is required to encode an offshore safety zone, it must be done using a **Restricted Area Navigational** feature (see clause X.X) or **Restricted Area Regulatory** feature (see clause X.X), with attribute **category of restricted area** = 1 (offshore safety zone).

14.1.4 Offshore flare stacks (see S-4 – B-445.2)

As with refineries on land, offshore terminals may burn off gas from production platforms or from “flare stacks” set up as separate structures a short distance from the production platforms.

If it is required to indicate the presence of a flare stack on an offshore platform, it must be done through population of the attribute **flare stack**.

Remarks:

- Flare stacks on land must be encoded, if required, using a **Landmark** feature (see clause X.X).

Distinction: Buoy installation; hulk; landmark; offshore production area; wind turbine.

Feature/Information associations							
Type	Association Name	Association Ends					
		Class	Role	Mult	Class	Role	Mult
Comp	Structure/Equipment	Offshore Platform	Supported by	0,1	Daymark, Fog Signal, Light Air Obstruction,	Supports	1,*

					Light All Around, Light Fog Detector, Light Sected, Physical AIS Aid to Navigation, Radar Transponder Beacon, Retroreflector, Signal Station Traffic, Signal Station Warning		
--	--	--	--	--	---	--	--

14.2 Submarine cables

IHO Definition: **SUBMARINE CABLE.** An assembly of wires or fibres, or a wire rope or chain, which has been laid underwater or buried beneath the sea floor. (IHO Dictionary – S-32).

S-101 Geo Feature: Cable submarine (CBLSUB)

Primitives: Curve

Real World

Paper Chart Symbol

ECDIS Symbol

S-101 Attribute	S-57 Acronym	Allowable Encoding Value	Type	Multiplicity
Buried depth	(BURDEP)		RE	0,1
Category of cable	(CATCBL)	1 : power line 6 : mooring cable/chain 7 : ferry 8 : fibre optic cable	EN	0,1
Condition	(CONDTN)	1 : under construction 5 : planned construction	EN	0,1
Feature name			C	0,*
Display name			(S) BO	0,1
Language		ISO 639-3	(S) TE	0,1
Name	(OBJNAM) (NOBJNM)		(S) TE	1,1
Fixed date range			C	0,1
Date end	(DATEND)	ISO 8601: 2004	(S) TD	0,1
Date start	(DATSTA)	ISO 8601: 2004	(S) TD	0,1
Status	(STATUS)	1 : permanent 4 : not in use 13 : historic 18 : existence doubtful	EN	0,*
Scale minimum	(SCAMIN)	See clause X.X	IN	0,1

INT 1 Reference: L 30.1, 31.1, 32; Q 42

14.2.1 Submarine cables (see S-4 – B-443; B-443.1-2 and B-443.7-8)

Submarine cables are used to carry power or telecommunications. All power cables and most telecommunication cables carry dangerous voltages. Submarine cables are potential hazards to both vessels and life, particularly to fishing vessels engaged in trawling the seabed. Where possible, submarine cables are now buried beneath the sea floor in water depths of less than 1000 metres; however there remains a large percentage unburied. Submarine cables are vulnerable to damage from anchoring, trawling or other seabed operations; even small craft anchors can penetrate a soft seabed sufficiently to foul a cable. Damage to telecommunication cables can lead to extensive disruption of national and international communications, whilst damage to power cables can disrupt electricity supply.

Submarine cables, including disused cables, should be encoded to indicate their presence to vessels engaged in anchoring, trawling or seabed activities in order to:

- Warn mariners of the potential hazard to their vessel, including electric shock to any vessel fouling or breaking the cable, possible capsizing of a small vessel if its fishing gear or anchor is trapped under the cable, or loss of gear (trawls or anchor cables).
- Prevent damage to the cable and avoid disrupting the service the cable may be providing.

Active cables should be encoded to a depth of 2000 metres (which is the deepest depth of water to which vessels may be endangered by fouling the cable).

If it is required to encode a submarine cable, it must be done using the feature **Cable Submarine**.

Remarks:

- If the buried depth varies along the cable, the cable must be encoded as several features.
- Telecommunications cables such as telephone and optic fibre cable must be populated, where required, by populating attribute **category of cable** = 8 (fibre optic cable).
- Where a cable is disused, it should be encoded with the attribute **status** = 4 (not in use), and the attribute **category of cable** should not be encoded. Few disused cables are recovered and so to encode them all would lead to clutter in the data. Also, accurate records of their positions are likely to be incomplete (some cables having been cut or dragged out of position), so there is a case for encoding them very selectively. Where disused cables traverse possible anchorages or where there is known seabed activity, for example trawling grounds, they should be encoded on the largest maximum display scale ENC data covering the area, provided they do not obscure more important information.
- In certain circumstances, high voltage power cables may cause a deviation in a ship's magnetic compass; in these cases, where reports have been received, they should be treated as local magnetic anomalies (see clause X.X).
- Cables, buried so deep that they are not vulnerable to damage from anchoring, should not be encoded (so that mariners are not unnecessarily inhibited from anchoring or fishing). In marginal cases they may be encoded as **Cable Submarine** with the nominal depth to which they are buried encoded using the attribute **buried depth**.

Distinction: Cable, overhead; cable area.

14.3 Submarine cable area

IHO Definition: CABLE AREA. An area which contains one or more submarine cables. (S-57 Edition 3.1, Appendix A – Chapter 1, Page 1.70, November 2000, as amended).				
S-101 Geo Feature: Cable area (CBLARE)				
Primitives: Surface				
<i>Real World</i>	<i>Paper Chart Symbol</i>	<i>ECDIS Symbol</i>		
S-101 Attribute	S-57 Acronym	Allowable Encoding Value	Type	Multiplicity
Category of cable	(CATCBL)	1 : power line 7 : ferry 8 : fibre optic cable	EN	0,*
Feature name			C	0,*
Display name			(S) BO	0,1
Language		ISO 639-3	(S) TE	0,1
Name	(OBJNAM) (NOBJNM)		(S) TE	1,1
Fixed date range			C	0,1
Date end	(DATEND)	ISO 8601: 2004	(S) TD	0,1
Date start	(DATSTA)	ISO 8601: 2004	(S) TD	0,1
Restriction	(RESTRN)	1 : anchoring prohibited 2 : anchoring restricted 3 : fishing prohibited 4 : fishing restricted 5 : trawling prohibited 6 : trawling restricted 7 : entry prohibited 8 : entry restricted 9 : dredging prohibited 11 : diving prohibited 12 : diving restricted 13 : no wake 14 : area to be avoided 16 : discharging prohibited 17 : discharging restricted 18 : industrial or mineral exploration/development prohibited 20 : drilling prohibited 23 : cargo transshipment (lightening) prohibited 24 : dragging prohibited 25 : stopping prohibited 27 : speed restricted 39 : swimming prohibited	EN	0,*
Status	(STATUS)	1 : permanent 7 : temporary 13 : historic	EN	0,*
Scale minimum	(SCAMIN)	See clause X.X	IN	0,1

INT 1 Reference: L 30.2, 31.2

14.3.1 Submarine cable areas (see S-4 – B-439.3 and B-443.3)

Cable areas should be encoded where:

- cables (including disused cables) are so numerous in an area that it would be impossible to encode them individually without impairing the legibility of the ENC; or
- a regulatory authority designates an area for the protection of a cable, or cables.

If it is required to encode a submarine cable area, it must be done using the feature **Cable Area**.

Remarks:

- Where populated, the attribute **status** must only be used to encode the status of the area and not the status of the cables in the area.
- The outer limits of a cable area must enclose the area in which anchoring and certain forms of fishing are prohibited or inadvisable; that is, the limits must lie a safe distance beyond the actual lines of the outermost cables.

Distinction: Cable, overhead; cable, submarine.

14.4 Submarine/land pipelines

IHO Definition: **PIPELINE.** A connected set of pipes for conveying liquids, slurries, or gases. (Defence Geospatial Information Working Group; Feature Data Dictionary Register, 2012).

S-101 Geo Feature: Pipeline submarine/on land (PIPSOL)

Primitives: Curve

Real World

Paper Chart Symbol

ECDIS Symbol

S-101 Attribute	S-57 Acronym	Allowable Encoding Value	Type	Multiplicity
Buried depth	(BURDEP)		RE	0,1
Category of pipeline/pipe	(CATPIP)	2 : outfall pipe 3 : intake pipe 4 : sewer 5 : bubbler system 6 : supply pipe	EN	0,*
Condition	(CONDTN)	1 : under construction 5 : planned construction	EN	0,1
Depth range minimum value	(DRVAL1)	DRVAL1 <= DRVAL2	RE	0,1
Depth range maximum value	(DRVAL2)	DRVAL2 >= DRVAL1	RE	0,1
Feature name			C	0,*
Display name			(S) BO	0,1
Language		ISO 639-3	(S) TE	0,1
Name	(OBJNAM) (NOBJNM)		(S) TE	1,1
Fixed date range			C	0,1
Date end	(DATEND)	ISO 8601: 2004	(S) TD	0,1
Date start	(DATSTA)	ISO 8601: 2004	(S) TD	0,1
Multiplicity of features			C	0,1
Multiplicity known			(S) BO	1,1
Number of features			(S) IN	0,1
Product	(PRODCT)	1 : oil 2 : gas 3 : water 7 : chemicals 8 : drinking water 9 : milk 18 : liquefied natural gas (LNG) 19 : liquefied petroleum gas (LPG)	EN	0,*
Reported date	(SORDAT)	ISO 8601: 2004	TD	0,1
Restriction	(RESTRN)	1 : anchoring prohibited 3 : fishing prohibited 4 : fishing restricted 5 : trawling prohibited 8 : entry restricted	EN	0,*

		9 : dredging prohibited 11 : diving prohibited 12 : diving restricted 13 : no wake 14 : area to be avoided 16 : discharging prohibited 17 : discharging restricted 18 : industrial or mineral exploration/development prohibited 20 : drilling prohibited 23 : cargo transshipment (lightening) prohibited 24 : dragging prohibited 25 : stopping prohibited 26 : landing prohibited 27 : speed restricted 39 : swimming prohibited		
Status	(STATUS)	1 : permanent 4 : not in use 7 : temporary 12 : illuminated	EN	0,*
Vertical length	(VERLEN)		RE	0,1
Scale minimum	(SCAMIN)	See clause X.X	IN	0,1

INT 1 Reference: D 29; L 40.1, 41.1, 42, 44

14.4.1 Pipelines, submarine or on land (see S-4 – B-377; B-444; B-444.1-2; B-444.4-5 and B-444.7)

Submarine pipelines can be divided into two main categories:

- Oil, chemical, gas and water supply pipelines are an important feature of many areas. The pipes are generally encased in concrete for protection and to give them negative buoyancy, which can significantly increase their external diameter. Pipelines are generally laid directly on the seabed, with sections over local dips or hollows being supported physically from beneath. In some cases (for example in shallow water or near the shore), where the external diameter of the pipeline would represent a significant reduction in the water depth above it, the pipelines may be laid in trenches and possibly buried. In all cases it must be assumed that the pipes are vulnerable to damage from anchoring or trawling, although in a few cases concrete domes are used to protect particularly vulnerable junctions. Gas pipes present a severe hazard to ships damaging them (by fire, explosion, or possibly loss of buoyancy). Oil and chemical pipes are a danger to the environment if fractured. Damage to water pipes supplying residential areas, mainly islands, results in disruption or contamination of the water supply. In the above cases, submarine pipelines must be encoded on all appropriate maximum display scale ENC datasets.
- Outfalls and intakes such as sewers, and cooling water intakes, are mainly a feature of inshore waters. For small craft, in particular, such pipes are a potential danger to navigation. The pipes are also vulnerable to damage. They should be encoded on at least the largest maximum display scale ENC datasets.

If it is required to encode a submarine or land pipeline, it must be done using the feature **Pipeline Submarine/On Land**.

Remarks:

- If the buried depth varies along a submerged pipeline, the pipeline must be encoded as several features.
- The attributes **depth range minimum value** and **depth range maximum value** are used to encode the shallowest and deepest depth over the pipeline.
- Where a pipeline is disused, it should be encoded with the attribute **status** = 4 (not in use), and the attributes **category of pipeline/pipe** and **product** should not be encoded.
- Submarine pipes, buried so deep that they are not vulnerable to damage from anchoring, should not be encoded (so that mariners are not unnecessarily inhibited from anchoring or fishing). In marginal cases they may be encoded as **Pipeline Submarine/On Land** with the nominal depth to which they are buried encoded using the attribute **buried depth**.
- Buried pipelines on land should not be encoded.

14.4.2 Diffusers, cribs

If it is required to encode diffusers and cribs, this must be done using **Obstruction** features (see clause X.X), with attribute **category of obstruction** = 3 (diffuser) or 4 (crib).

Distinction: Pipeline, overhead, submarine pipeline area.

14.5 Submarine pipeline area

IHO Definition: **SUBMARINE PIPELINE AREA.** An area containing one or more submarine pipelines. (Adapted from S-57 Edition 3.1, Appendix A – Chapter 1, Page 1.118, November 2000).

S-101 Geo Feature: Submarine pipeline area (PIPARE)

Primitives: Point, Surface

<i>Real World</i>	<i>Paper Chart Symbol</i>	<i>ECDIS Symbol</i>
-------------------	---------------------------	---------------------

S-101 Attribute	S-57 Acronym	Allowable Encoding Value	Type	Multiplicity
Category of pipeline/pipe	(CATPIP)	2 : outfall pipe 3 : intake pipe 4 : sewer 5 : bubbler system 6 : supply pipe	EN	0,*
Feature name			C	0,*
Display name			(S) BO	0,1
Language		ISO 639-3	(S) TE	0,1
Name	(OBJNAM) (NOBJNM)		(S) TE	1,1
Fixed date range			C	0,1
Date end	(DATEND)	ISO 8601: 2004	(S) TD	0,1
Date start	(DATSTA)	ISO 8601: 2004	(S) TD	0,1
Product	(PRODCT)	1 : oil 2 : gas 3 : water 7 : chemicals 8 : drinking water 18 : liquefied natural gas (LNG) 19 : liquefied petroleum gas (LPG)	EN	0,*
Restriction	(RESTRN)	1 : anchoring prohibited 2 : anchoring restricted 3 : fishing prohibited 4 : fishing restricted 5 : trawling prohibited 6 : trawling restricted 7 : entry prohibited 8 : entry restricted 9 : dredging prohibited 10 : dredging restricted 11 : diving prohibited 12 : diving restricted 13 : no wake 14 : area to be avoided 15 : construction prohibited 16 : discharging prohibited 17 : discharging restricted 18 : industrial or mineral exploration/development prohibited	EN	0,*

		19 : industrial or mineral exploration/development restricted 20 : drilling prohibited 21 : drilling restricted 22 : removal of historical artefacts prohibited 23 : cargo transhipment (lightening) prohibited 24 : dragging prohibited 25 : stopping prohibited 26 : landing prohibited 39 : swimming prohibited		
Status	(STATUS)	1 : permanent 4 : not in use 7 : temporary	EN	0,*
Scale minimum	(SCAMIN)	See clause X.X	IN	0,1

INT 1 Reference: L 40.2, 41.2

14.5.1 Submarine pipeline areas (see S-4 – B-439.3 and B-444.3)

Submarine pipeline areas should be encoded where:

- pipelines (including disused pipelines) are so numerous in an area that it would be impossible to encode them individually without impairing the legibility of the ENC; or
- a regulatory authority designates an area for the protection of a pipeline, or pipelines.

If it is required to encode a submarine pipeline area, it must be done using the feature **Submarine Pipeline Area**.

Remarks:

- Where populated, the attribute **status** must only be used to encode the status of the area and not the status of the pipelines in the area.
- The outer limits of a pipeline area must correspond to the area in which anchoring, trawling and dredging are prohibited or inadvisable; that is, the limits must lie at a safe distance beyond the actual lines of the outermost pipes.
- Where a pipeline area is disused, the **Submarine Pipeline Area** should be encoded with the attribute **Status = 4** (not in use), and the attributes **category of pipeline/pipe** and **product** should not be encoded.

Distinction: Pipeline, overhead; pipeline, submarine/on land.

14.6 Offshore production area

IHO Definition: OFFSHORE PRODUCTION AREA. An area at sea within which there are production facilities. (S-57 Edition 3.1, Appendix A – Chapter 1, Page 1.113, November 2000).				
S-101 Geo Feature: Offshore production area (OSPARE)				
Primitives: Surface				
<i>Real World</i>	<i>Paper Chart Symbol</i>	<i>ECDIS Symbol</i>		
S-101 Attribute	S-57 Acronym	Allowable Encoding Value	Type	Multiplicity
Category of offshore production area	(CATPRA)	1 : offshore wind farm 2 : wave farm 3 : current farm 4 : tank farm 5 : seabed material extraction area	EN	0,1
Condition	(CONDTN)	1 : under construction 2 : ruined 4 : wingless 5 : planned construction	EN	0,1
Feature name			C	0,*
Display name			(S) BO	0,1
Language		ISO 639-3	(S) TE	0,1
Name	(OBJNAM) (NOBJNM)		(S) TE	1,1
Fixed date range			C	0,1
Date end	(DATEND)	ISO 8601: 2004	(S) TD	0,1
Date start	(DATSTA)	ISO 8601: 2004	(S) TD	0,1
Height	(HEIGHT)		RE	0,1
Product	(PRODCT)	1 : oil 2 : gas 4 : stone 6 : ore 10 : bauxite 14 : sand 23 : electricity	EN	0,*
Radar conspicuous	(CONRAD)		BO	0,1
Reported date	(SORDAT)	ISO 8601: 2004	TD	0,1
Restriction	(RESTRN)	1 : anchoring prohibited 2 : anchoring restricted 3 : fishing prohibited 4 : fishing restricted 5 : trawling prohibited 6 : trawling restricted 7 : entry prohibited 8 : entry restricted 9 : dredging prohibited 10 : dredging restricted 11 : diving prohibited 12 : diving restricted	EN	0,*

		13 : no wake 14 : area to be avoided 15 : construction prohibited 16 : discharging prohibited 17 : discharging restricted 18 : industrial or mineral exploration/development prohibited 19 : industrial or mineral exploration/development restricted 20 : drilling prohibited 21 : drilling restricted 22 : removal of historical artefacts prohibited 23 : cargo transhipment (lightening) prohibited 24 : dragging prohibited 25 : stopping prohibited 26 : landing prohibited 27 : speed restricted 39 : swimming prohibited		
Status	(STATUS)	1 : permanent 4 : not in use 7 : temporary 8 : private 12 : illuminated 28 : buoyed	EN	0,*
Vertical length	(VERLEN)		RE	0,1
Visually conspicuous	(CONVIS)	1 : visually conspicuous 2 : not visually conspicuous 3 : prominent	EN	0,1
Scale minimum	(SCAMIN)	See clause X.X	IN	0,1

INT 1 Reference: L 4, 5.2

14.6.1 Offshore production areas (see S-4 – B-445.3; B-445.7; B-445.9; B-445.11 and B-445.12)

Oil and gas fields are exploited in many parts of the world. Although the basic methods for extracting oil and gas are well established, details of the systems and structures may vary with the characteristics of the different fields and are continually being developed. In a typical field, oil or gas is obtained from wells drilled from fixed production platforms, usually standing on the seabed. From each production platform, the oil or gas is carried in pipes to a facilities platform where primary processing, compression and pumping are carried out. The oil or gas is then transported through pipelines to a nearby storage tank, tanker loading buoy or floating terminal, or direct to a tank farm on shore. One facilities platform may collect the oil or gas from several production platforms, and may supply a number of tanker loading buoys or storage units. Such facilities platforms are sometimes termed Field Terminal Platforms. Converted tankers or purpose-built vessels are often permanently moored and used as facilities platforms, floating terminals, and for storage.

Other offshore energy production facilities include wind turbines and underwater current turbines. Other methods of harnessing tidal and wave energy are also in use.

If it is required to encode an offshore production area, it must be done using the feature **Offshore Production Area**.

Remarks:

- General information about a wind farm such as blade diameter and blade vertical clearance should be encoded, if required, using an associated instance of the information class **Nautical Information** (see clause X.X), complex attribute **information**. If it is required to encode individual offshore wind turbines, it should be done using a **Wind Turbine** feature (see clause X.X).
- If it is required to encode individual wave energy devices or underwater turbines within a wave or current farm (or turbine field), it should be done using an **Obstruction** feature (see clause X.X) or, if there are associated surface structures, using appropriate features, for example **Offshore Platform** or **Beacon Special Purpose/General** (see clauses X.X and X.X). The extent and nature of any restricted area related

to the feature should be encoded using a **Restricted Area Navigational** feature (see clause X.X) or **Restricted Area Regulatory** feature (see clause X.X).

- If it is required to encode an offshore development area, it should be done using an **Offshore Production Area** feature, with attributes **category of offshore production area** and **product** populated with the appropriate value; and **condition** = 1 (under construction). A note describing the activities taking place within the area may be included using an associated instance of the information class **Nautical Information** (see clause X.X), complex attribute **information**. At the conclusion of the development of the area, the attribute **condition** and any associated note can then be removed from the feature.

14.6.2 Offshore tanker loading systems (see S-4 – B-445.4)

Although the oil and gas from some fields are sent ashore by submarine pipeline, a variety of mooring systems have been developed for use in deep water and in the vicinity of certain ports, to allow the loading of large vessels and the permanent mooring of floating storage vessels or units. These offshore systems include large mooring buoys, designed for mooring vessels up to 500,000 tonnes, and platforms on structures fixed at their lower ends to the sea floor. They allow a vessel to moor forward or aft to them, and to swing to the wind or stream. Those which are fixed are termed Single Point Moorings (SPM). Those which are a form of mooring buoy are termed Single Buoy Moorings (SBM). Like production platforms, SPM and SBM normally have lights and fog signals.

If it is required to encode an offshore tanker loading system, it must be done using the feature **Buoy Installation** (see clause X.X).

If it is required to encode an articulated tower, it must be done using an **Offshore Platform** feature (see clause X.X), with attribute:

- category of offshore platform** - 4 - articulated loading platform (ALP)
5 - single anchor leg mooring (SALM)
8 - floating production, storage and off-loading vessel (FPSO)
10 - navigation, communication and control buoy (NCCB) (which may include storage facilities)

Distinction: Exclusive Economic Zone; offshore platform; wind turbine.

15 Geo Features – Tracks and Routes

15.1 Leading, clearing and transit lines and recommended tracks (see S-4 – B-433 and B-434)

If it is required to encode leading, clearing and transit lines and recommended tracks, it must be done using the features **Navigation Line** and **Recommended Track** (see clauses X.X and X.X), and related point navigational aids features (see section XX). This applies for visual and radio navigational aids.

NB. In North America the word “range” is used instead of “transit” and “leading line”.

15.1.1 Range systems - relationship

To encode a range system, the features **Navigation Line**, **Recommended Track** and the navigational aids features should be associated with the feature **Range System** (see clause X.X) using the association **Range System Aggregation** (see clause X.X).

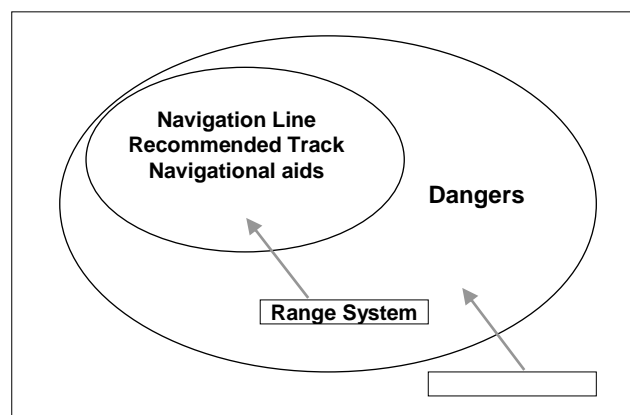

Remarks:

- All features comprising a range system must have the same value populated for the attribute **scale minimum** (see clause X.X).

15.2 Traffic Lanes

A traffic lane is an area within defined limits in which one way traffic is established. Natural obstacles, including those forming separation zones may constitute a boundary (IMO Ships' Routeing, 2010). These lanes of travel may be composed of the following features: **Traffic Separation Scheme Lane Part** and **Deep Water Route Part**.

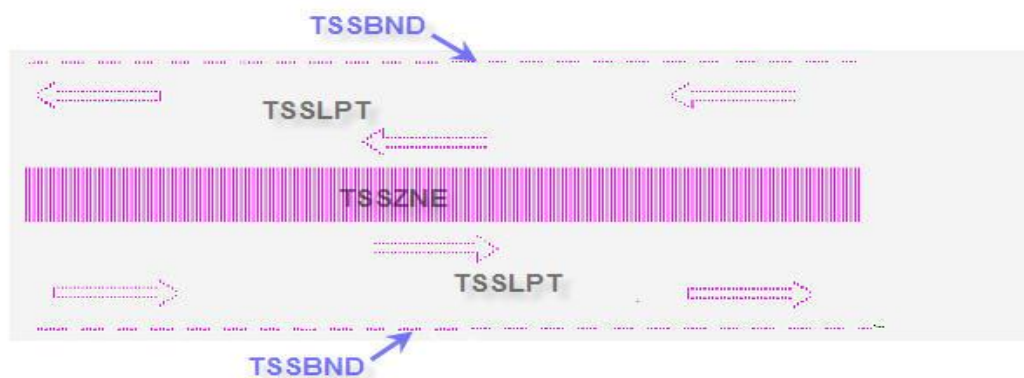

Traffic Lanes - Example

15.3 Traffic separation schemes and traffic separation scheme systems (see S-4 – B-435.1-3)

A traffic separation scheme is a routing measure aimed at the separation of opposing streams of traffic by appropriate means and by the establishment of traffic lanes (IMO Ships' Routeing, 2010). A traffic separation scheme separates opposing streams of marine traffic by the establishment of separation zones or lines and traffic lanes. It may include inshore traffic zones or Deep Water routes. A separation zone or line separates:

- 1) The traffic lanes in which ships are proceeding in opposite or nearly opposite directions,
- 2) A traffic lane from the adjacent sea area, or
- 3) Traffic lanes designated for particular classes of ships proceeding in the same direction.

If it is required to encode a traffic separation scheme, it must be done using:

- Deep Water routes (DW – a route within defined limits which has been accurately surveyed for clearance of sea bottom and submerged obstacles as indicated on the chart (IMO Ships' Routeing, 2010)). Deep Water routes are encoded using **Deep Water Route Centreline** and **Deep Water Route Part** features (see clauses X.X and X.X);
- **Inshore Traffic Zone** (see clause X.X);
- **Precautionary Area** (see clause X.X);
- **Traffic Separation Line, Traffic Separation Zone, Traffic Separation Scheme Boundary, Traffic Separation Scheme Crossing, Traffic Separation Scheme Lane Part, Traffic Separation Scheme Roundabout** (see clauses X.X to X.X); and
- Navigational aids features (see Sections XX and XX).

For guidance on provision of advance notification of changes to traffic separation schemes, see clause X.X.

To encode a traffic separation scheme (TSS) system, the Deep Water Route Centreline, Deep Water Route Part, Inshore Traffic Zone, Precautionary Area, Traffic Separation Line, Traffic Separation Zone, Traffic Separation Scheme Boundary, Traffic Separation Scheme Crossing, Traffic Separation Scheme Lane Part, Traffic Separation Scheme Roundabout features, and the navigational aids features (if they are stated in the regulation defining the TSS or Deep Water route), must be associated with the feature **Traffic Separation Scheme** (see clause X.X) using the association **Traffic Separation Scheme Aggregation** (see clause X.X). Where it is required to indicate the name of the complete TSS, this must be done using the attribute feature name for the Traffic Separation Scheme feature. Where it is required to populate textual information for the TSS, this should be done using a **Caution Area** (see clause X.X) or an **Information Area** feature (see clause X.X), having an associated instance of the information class **Nautical Information** (see clause X.X), complex attribute **information**.

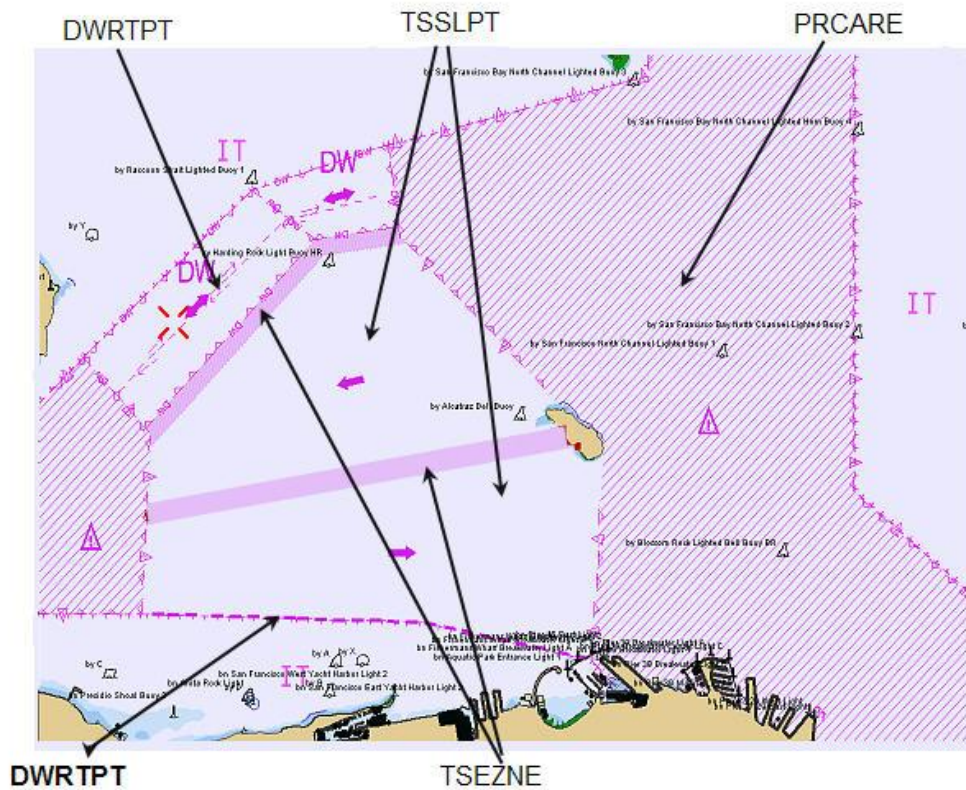

Sample Traffic Separation Scheme (TSS) and Deep Water route (DW)

Remarks:

- Traffic separation scheme systems may be included with other routing measures such as Deep Water or two-way routes, or another traffic separation scheme system, to comprise a complete traffic routing system. To encode the relationship between routing measures, the named composition defining each routing measure within the system (or the relevant feature if the routing measure consists of a single feature) may be collected using a **Traffic Separation Scheme** named composition to form a hierarchical relationship (see clause X.X). The individual elements comprising different routing measures must not be aggregated into a single named composition.
- All features comprising a TSS, TSS system or deep water route must have the same value populated for the attribute **scale minimum** (see clause X.X).

15.4 Navigation line

IHO Definition: NAVIGATION LINE. A straight line extending towards an area of navigational interest and generally generated by two navigational aids or one navigational aid and a bearing. (Service Hydrographique et Oceanographique de la Marine, France).

S-101 Geo Feature: Navigation line (NAVLNE)

Primitives: Curve

<i>Real World</i>	<i>Paper Chart Symbol</i>	<i>ECDIS Symbol</i>
-------------------	---------------------------	---------------------

S-101 Attribute	S-57 Acronym	Allowable Encoding Value	Type	Multiplicity
Category of navigation line	(CATNAV)	1 : clearing line 2 : transit line 3 : leading line bearing a recommended track	EN	1,1
Fixed date range			C	0,1
Date end	(DATEND)	ISO 8601: 2004	(S) TD	0,1
Date start	(DATSTA)	ISO 8601: 2004	(S) TD	0,1
Measured distance			IN	0,1
Orientation			C	1,1
Orientation uncertainty			(S) RE	0,1
Orientation value	(ORIENT)		(S) RE	1,1
Periodic date range			C	0,*
Date end	(PEREND)	ISO 8601: 2004	(S) TD	1,1
Date start	(PERSTA)	ISO 8601: 2004	(S) TD	1,1
Status	(STATUS)	1 : permanent 2 : occasional 5 : periodic/intermittent 7 : temporary 8 : private 14 : public	EN	0,*
Scale minimum	(SCAMIN)	See clause X.X	IN	0,1

INT 1 Reference: M 1-2; Q 122

15.4.1 Navigation lines (see S-4 – B-433)

Clearing Lines are important in rocky areas where dangers are not guarded by buoys and where sailing vessels (which are not always able to keep to a direct track) and other small craft may navigate close inshore. Transits marking isolated dangers are based on beacons or other marks which are erected on shore to indicate (approximately, unless there are two pairs of beacons) the position of an isolated danger. Leading lines based on beacons or lights must be encoded where the maximum display scale for the ENC data permits. Leading lines based on natural features should be encoded on the largest maximum display scale ENC data where they appear to be useful, particularly if other navigational aids seem inadequate.

If it is required to encode a navigation line, it must be done using the feature **Navigation Line**.

The use of **Navigation Line** and **Recommended Track** (see clause X.X) is defined in more detail in the following Table, and in the Figure below:

Figure		Navigation Line	Recommended Track	Navigational Aids
1	Recommended track on a leading line	category of navigation line = 3	category of recommended track = 1	at least 2
2	Clearing line on marks in line	category of navigation line = 1	none	at least 2
3	Transit line on marks in line	category of navigation line = 2	none	at least 2
4	Recommended track on a bearing	category of navigation line = 3	category of recommended track = 1	1
5	Clearing line on a bearing	category of navigation line = 1	none	1
6	Transit line on a bearing	category of navigation line = 2	none	1
7	Recommended track not based on fixed marks	none	category of recommended track = 2	none

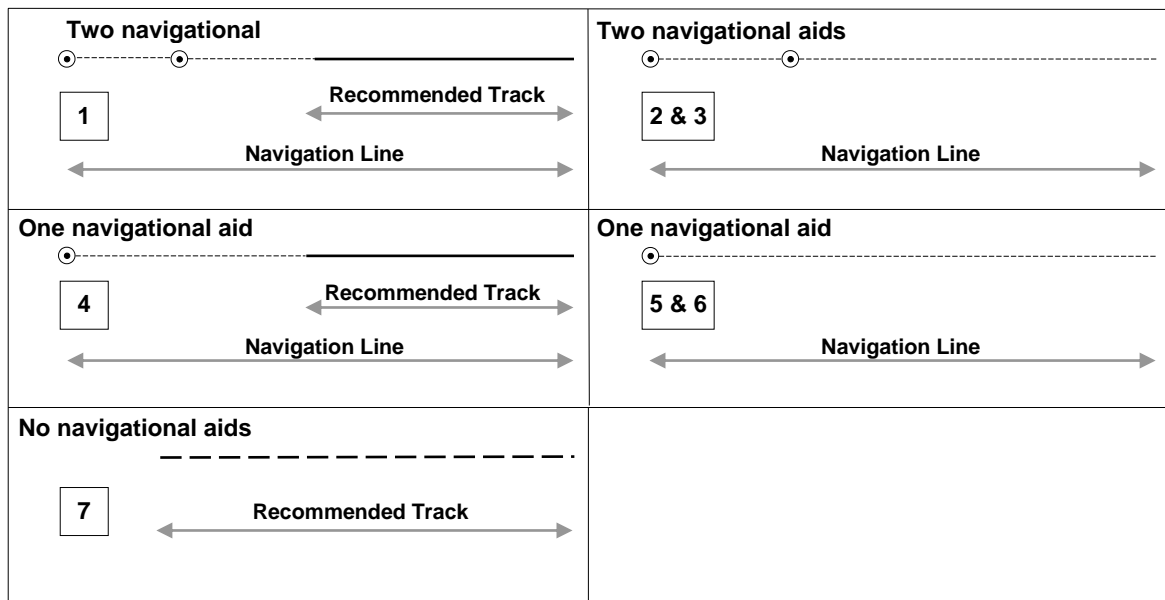

Remarks:

- The value populated for the mandatory complex attribute **orientation** must be the value of the bearing from seaward.
- The extent of the navigation line depends on the visibility of the navigational aids.
- The recommended track is that portion of a navigation line that a ship should use for navigation.

15.4.2 Measured distances (see S-4 – B-458)

If the track to be followed is on a leading line or a bearing, it must be encoded in the way described in the Table and Figure above (cases 1 or 4). If the track is not on a leading line or bearing, it must be encoded only as a **Navigation Line** feature with the attribute **category of navigation line** being set to an empty (null) value. In either case, if it is required to encode the measured distance, it must be done using the attribute **measured distance**.

If it is required to encode the transit lines, they must be done using **Navigation Line** features, with **category of navigation line** = 2 (transit line).

If it is required to encode the beacons, they must be done using **Beacon Special Purpose/General** features, with attribute **category of special purpose mark** = 17 (measured distance mark).

On occasions, one or more of the transits used for the measured distance may incorporate an existing landmark as the front or rear mark. In this case, if **Landmark** is encoded, **category of special purpose mark = 17** must also be populated.

Where the entire measured distance system exists within a single dataset, each transit line with its beacons must be associated with the feature **Range System** (see clause X.X) using the association **Range System Aggregation** (see clause X.X). These two associations and the track to be followed must be associated with another instance of **Range System** to form a hierarchical relationship.

Remarks:

- All features comprising a measured distance must have the same value populated for the attribute **scale minimum** (see clause X.X).

Distinction: Recommended route; recommended track.

Feature/Information associations

Type	Association Name	Association Ends					
		Class	Role	Mult	Class	Role	Mult
Aggr	Range System Aggregation	Navigation Line	Consists of	1,*	Range System	Component of	0,1

15.5 Recommended track

IHO Definition: **RECOMMENDED TRACK**. A route which has been specially examined to ensure so far as possible that it is free of dangers and along which ships are advised to navigate. (IMO Ships' Routeing, 2010).

S-101 Geo Feature: Recommended track (RECTRC)

Primitives: Curve

Real World

Paper Chart Symbol

ECDIS Symbol

S-101 Attribute	S-57 Acronym	Allowable Encoding Value	Type	Multiplicity
Category of recommended track	(CATTRK)	1 : based on a system of fixed marks 2 : not based on a system of fixed marks	EN	1,1
Depth range minimum value	(DRVAL1)		RE	0,1
Feature name			C	0,*
Display name			(S) BO	0,1
Language		ISO 639-3	(S) TE	0,1
Name	(OBJNAM) (NOBJNM)		(S) TE	1,1
Fixed date range			C	0,1
Date end	(DATEND)	ISO 8601: 2004	(S) TD	0,1
Date start	(DATSTA)	ISO 8601: 2004	(S) TD	0,1
Maximum permitted draught	(INFORM) (NINFOM)		RE	0,1
Orientation			C	1,1
Orientation uncertainty			(S) RE	0,1
Orientation value	(ORIENT)		(S) RE	1,1
Periodic date range			C	0,*
Date end	(PEREND)	ISO 8601: 2004	(S) TD	1,1
Date start	(PERSTA)	ISO 8601: 2004	(S) TD	1,1
Quality of vertical measurement	(QUASOU)	1 : depth known 2 : depth or least depth unknown 6 : least depth known	EN	0,*
Status	(STATUS)	1 : permanent 2 : occasional 5 : periodic/intermittent 7 : temporary 9 : mandatory 12 : illuminated 16 : watched 17 : un-watched	EN	0,*
Technique of vertical measurement	(TECSOU)	1 : found by echo-sounder 2 : found by side scan sonar 3 : found by multi-beam 6 : swept by wire-drag	EN	0,*

		8 : swept by vertical acoustic system 9 : found by electromagnetic sensor 13 : swept by side-scan sonar 15 : found by LIDAR		
Traffic flow	(TRAFIC)	1 : inbound 2 : outbound 3 : one-way 4 : two-way	EN	1,1
Vertical uncertainty	(SOUACC)		C	0,1
Uncertainty fixed			(S) RE	1,1
Uncertainty variable			(S) RE	0.1
Scale minimum	(SCAMIN)	See clause X.X	IN	0,1

INT 1 Reference: M 3-6

15.5.1 Recommended tracks (see S-4 – B-432.1; B-434 and B-434.1-4)

Recommended tracks and fairways usually comprise a number of sections (sometimes termed “legs”) which lead between dangers lying close on both sides of the track or fairway. Tracks commonly include some sections which are leading lines (see clause X.X). The distinction between tracks and fairways, in this context, is that tracks have no specified outer limits and fairways do have specified outer limits.

It is important to recognise that it is not the role of cartographers to create “recommended” tracks and other “recommended” routing measures; such recommendations are made by other authorities. The word “Recommended”, used in connection with recommended tracks and other recommended routing measures usually implies that it has been recommended by a competent authority (such as a port authority within its port limits or a maritime safety authority) and may be adopted by IMO. Occasionally, the recommendation may be based on advice directly from a competent surveyor or established by precedent.

Recommended tracks include all channels recommended for hydrographic reasons to lead safely between shoal depths. The use of such tracks is generally left to the discretion of the mariner and will depend on the vessel’s draught, the state of the tide, adequacy of navigational aids and so on.

If it is required to encode a recommended track, it must be done using the feature **Recommended Track**.

The use of **Navigation Line** and **Recommended Track** is defined in more detail in the following Table, and in the Figure below.

Figure		Navigation Line	Recommended Track	Navigational Aids
1	Recommended track on a leading line	category of navigation line = 3	category of recommended track = 1	at least 2
2	Clearing line on marks in line	category of navigation line = 1	none	at least 2
3	Transit line on marks in line	category of navigation line = 2	none	at least 2
4	Recommended track on a bearing	category of navigation line = 3	category of recommended track = 1	1
5	Clearing line on a bearing	category of navigation line = 1	none	1
6	Transit line on a bearing	category of navigation line = 2	none	1
7	Recommended track not based on fixed marks	none	category of recommended track = 2	none

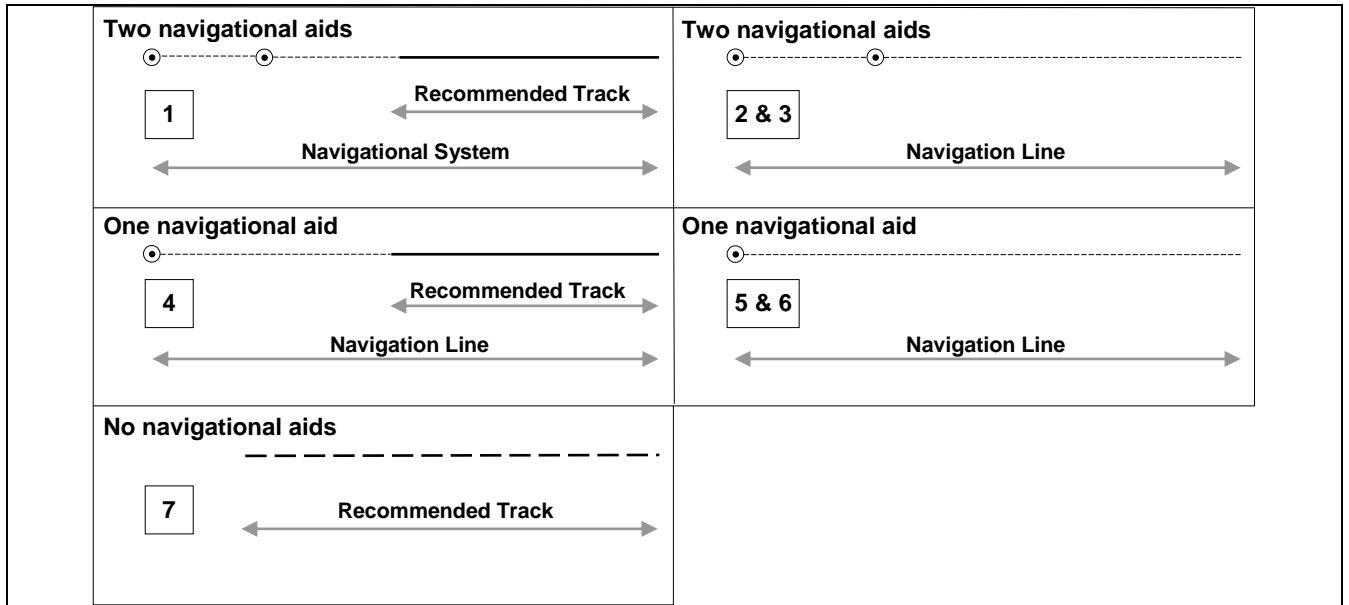

Remarks:

- The attribute **depth range minimum value** is used to encode the shallowest depth along the track, where required.
- The attribute **maximum permitted draught** is used to encode the maximum draught permitted on the track, where required.
- The recommended track is that portion of a navigation line (see clause X.X) that a ship should use for navigation (see Figure above).
- In the case of a two-way recommended track, only one value of orientation is encoded (in the complex attribute **orientation**); the other value can be deduced (that is, the value in **orientation (orientation value) + 180 degrees**). The value of orientation encoded on **orientation (orientation value)** should be the value of the bearing from seaward. If it is not possible to define a seaward direction, the value that is less than 180° should be used.
- When the traffic flow along a recommended track is one way (attribute **traffic flow = 1, 2 or 3**), the resultant direction of the line (accounting for the direction of digitising and any subsequent reversal of the line) associated with the **Recommended Track** must be the same as the direction of the traffic flow, in order to ensure the correct representation in the ECDIS of the direction to be followed.

Distinction: Fairway; navigation line; recommended route centreline; recommended traffic lane part.

Feature/Information associations							
Type	Association Name	Association Ends					
		Class	Role	Mult	Class	Role	Mult
Aggr	Range System Aggregation	Recommended Track	Consists of	1,*	Range System	Component of	0,1

15.6 Range system

IHO Definition: RANGE SYSTEM . Definition required.				
S-101 Geo Feature: Range system				
Primitives: None				
<i>Real World</i>		<i>Paper Chart Symbol</i>		<i>ECDIS Symbol</i>
S-101 Attribute	S-57 Acronym	Allowable Encoding Value	Type	Multiplicity
Feature name			C	0,*
Display name			(S) BO	0,1
Language		ISO 639-3	(S) TE	0,1
Name	(OBJNAM) (NOBJNM)		(S) TE	1,1
Maximum permitted draught			RE	0,1
<p><u>INT 1 Reference:</u></p> <p>15.6.1 Range systems (see S4 – B-433)</p> <p>If it is required to encode leading, clearing and transit lines and recommended tracks, it must be done using the features Navigation Line and Recommended Track (see clauses X.X and X.X), and related point navigational aids features (see section XX). This applies for visual and radio navigational aids.</p> <p>To encode a range system, the features Navigation Line, Recommended Route Centreline, Recommended Track and the navigational aids features should be associated with the feature Range System using the association Range System Aggregation (see clause X.X).</p> <p><u>Remarks:</u></p> <ul style="list-style-type: none"> The name of the range system may be populated using the complex attribute feature name. All features comprising a range system must have the same value populated for the attribute scale minimum (see clause X.X). Multiple Range System aggregations may be further aggregated hierarchically to define a higher level range system. <p><u>Distinction:</u></p>				

Feature/Information associations							
Type	Association Name	Association Ends					
		Class	Role	Mult	Class	Role	Mult
Aggr	Range System Aggregation	Range System	Component of	0,1	Beacon Cardinal, Beacon Isolated Danger, Beacon Lateral, Beacon Safe Water, Beacon Special Purpose/General, Building, Daymark, Fortified Structure, Landmark, Light All Around, Light Sectored, Mooring/Warping	Consists of	1,*

					Facility, Navigation Line, Pile, Recommended Route Centreline, Recommended Track, Silo/Tank,		
--	--	--	--	--	---	--	--

15.7 Fairways

IHO Definition: FAIRWAY . That part of a river, harbour and so on, where the main navigable channel for vessels of larger size lies. It is also the usual course followed by vessels entering or leaving harbours, called “ship channel”. (International Maritime Dictionary, 2 nd Edition).				
S-101 Geo Feature: Fairway (FAIRWY)				
Primitives: Surface				
<i>Real World</i>		<i>Paper Chart Symbol</i>		<i>ECDIS Symbol</i>
S-101 Attribute	S-57 Acronym	Allowable Encoding Value	Type	Multiplicity
Depth range minimum value	(DRVAL1)		RE	0,1
Feature name			C	0,*
Display name			(S) BO	0,1
Language		ISO 639-3	(S) TE	0,1
Name	(OBJNAM) (NOBJNM)		(S) TE	1,1
Fixed date range			C	0,1
Date end	(DATEND)	ISO 8601: 2004	(S) TD	0,1
Date start	(DATSTA)	ISO 8601: 2004	(S) TD	0,1
Maximum permitted draught			RE	0,1
Orientation			C	0,1
Orientation uncertainty			(S) RE	0,1
Orientation value	(ORIENT)		(S) RE	1,1
Quality of vertical measurement	(QUASOU)	1 : depth known 2 : depth or least depth unknown 6 : least depth known	EN	0,*
Restriction	(RESTRN)	1 : anchoring prohibited 2 : anchoring restricted 3 : fishing prohibited 4 : fishing restricted 5 : trawling prohibited 6 : trawling restricted 8 : entry restricted 9 : dredging prohibited 10 : dredging restricted 11 : diving prohibited 12 : diving restricted 13 : no wake 15 : construction prohibited 16 : discharging prohibited 17 : discharging restricted 18 : industrial or mineral exploration/development prohibited 19 : industrial or mineral exploration/development restricted 20 : drilling prohibited	EN	0,*

		21 : drilling restricted 22 : removal of historical artefacts prohibited 23 : cargo transhipment (lightening) prohibited 24 : dragging prohibited 25 : stopping prohibited 27 : speed restricted 39 : swimming prohibited		
Status	(STATUS)	1 : permanent 3 : recommended 6 : reserved 7 : temporary 9 : mandatory 28 : buoyed	EN	0,*
Traffic flow	(TRAFIC)	1 : inbound 2 : outbound 3 : one-way 4 : two-way	EN	0,1
Vertical uncertainty	(<i>SOUACC</i>)		C	0,1
Uncertainty fixed			(S) RE	1,1
Uncertainty variable			(S) RE	0.1
Scale minimum	(SCAMIN)	See clause X.X	IN	0,1

INT 1 Reference: M 18

15.7.1 Fairways (see S-4 – B-432.1(c) and B-434.5)

A fairway, sometimes called Ship Channel, is the main navigable channel in the approaches to, or within, a river or harbour. Fairways which are designated by a regulatory authority are treated as Routeing Measures.

If it is required to encode a fairway, it must be done using the feature **Fairway**.

Remarks:

- The attribute **depth range minimum value** is used to encode the shallowest depth in the fairway, where known.
- Where beacons or buoys marking a fairway are offset from the actual fairway limits, this should be indicated using an associated instance of the information class **Nautical Information** (see clause X.X), complex attribute **information**.

Distinction: Deep Water route centreline; Deep Water route part; traffic separation scheme lane part.

Feature/Information associations							
Type	Association Name	Association Ends					
		Class	Role	Mult	Class	Role	Mult
Aggr	Fairway Aggregation	Fairway	Consists of	2,*	Fairway System	Component of	0,1
Asso	Fairway Auxiliary	Fairway	Auxiliary to	0,1	Beacon Cardinal, Beacon Isolated Danger, Beacon Lateral, Beacon Safe Water, Beacon Special Purpose/General, Buoy Cardinal, Buoy Emergency Wreck Marking, Buoy Isolated Danger, Buoy Lateral, Buoy Safe Water, Buoy Special	Has auxiliary	1,*

					Purpose/General, Caution Area, Daymark, Dredged Area, Light Float, Light Vessel, Landmark, Pile, Range System, Recommended Route Centreline, Recommended Track, Restricted Area Navigational, Restricted Area Regulatory, Swept Area		
--	--	--	--	--	---	--	--

15.8 Fairway systems

IHO Definition: **FAIRWAY.** That part of a river, harbour and so on, where the main navigable channel for vessels of larger size lies. It is also the usual course followed by vessels entering or leaving harbours, called “ship channel”. (International Maritime Dictionary, 2nd Edition).

A fairway system is an aggregation of connected fairway features making up a complex fairway system.

S-101 Geo Feature: Fairway system

Primitives: None

<i>Real World</i>	<i>Paper Chart Symbol</i>	<i>ECDIS Symbol</i>
-------------------	---------------------------	---------------------

S-101 Attribute	S-57 Acronym	Allowable Encoding Value	Type	Multiplicity
Feature name			C	0,*
Display name			(S) BO	0,1
Language		ISO 639-3	(S) TE	0,1
Name	(OBJNAM) (NOBJNM)		(S) TE	1,1
Fixed date range			C	0,1
Date end	(DATEND)	ISO 8601: 2004	(S) TD	0,1
Date start	(DATSTA)	ISO 8601: 2004	(S) TD	0,1
Maximum permitted draught			RE	0,1
Periodic date range			C	0,*
Date end	(PEREND)	ISO 8601: 2004	(S) TD	1,1
Date start	(PERSTA)	ISO 8601: 2004	(S) TD	1,1

INT 1 Reference: M 18

15.8.1 Fairway systems (see S-4 – B-432.1(c) and B-434.5)

A fairway, sometimes called Ship Channel, is the main navigable channel in the approaches to, or within, a river or harbour. Fairways which are designated by a regulatory authority are treated as Routing Measures.

A fairway system is composed of two or more **Fairway** features that comprise a complex fairway routing system, for instance a long fairway comprising several bends. To define the complete fairway system, the **Fairway** features must be collected using the named aggregation feature **Fairway System**.

Remarks:

- The name of the complete fairway system must be populated using the complex attribute **feature name**.
- Where it is required to populate textual information for the fairway system, this should be done using an associated instance of the information class **Nautical Information** (see clause X.X), complex attribute **information**, or if the information is considered essential for safe navigation, using a **Caution Area** feature (see clause X.X).

Distinction: Deep Water route; traffic separation scheme; two-way route.

Feature/Information associations

Type	Association Name	Association Ends					
		Class	Role	Mult	Class	Role	Mult

Aggr	Fairway Aggregation	Fairway System	Component of	0,1	Fairway	Consists of	2,*
Asso	Aids to Navigation Association	Fairway System	Component of	0,1	Beacon Cardinal, Beacon Isolated Danger, Beacon Lateral, Beacon Safe Water, Beacon Special Purpose/General, Buoy Cardinal, Buoy Emergency Wreck Marking, Buoy Isolated Danger, Buoy Lateral, Buoy Safe Water, Buoy Special Purpose/General, Daymark, Light Float, Light Vessel, Landmark, Pile	Consists of	1,*

15.9 Recommended routes

IHO Definition: **RECOMMENDED ROUTE CENTRELINE.** The recommended route centreline indicates the “centreline” of a recommended route. (S-57 Edition 3.1, Appendix A – Chapter 1, Page 1.137, November 2000).

S-101 Geo Feature: Recommended route centreline (RCRTCL)

Primitives: Curve

Real World

Paper Chart Symbol

ECDIS Symbol

S-101 Attribute	S-57 Acronym	Allowable Encoding Value	Type	Multiplicity
Category of recommended track	(CATTRK)	1 : based on a system of fixed marks 2 : not based on a system of fixed marks	EN	1,1
Depth range minimum value	(DRVAL1)		RE	0,1
Feature name			C	0,*
Display name			(S) BO	0,1
Language		ISO 639-3	(S) TE	0,1
Name	(OBJNAM) (NOBJNM)		(S) TE	1,1
Fixed date range			C	0,1
Date end	(DATEND)	ISO 8601: 2004	(S) TD	0,1
Date start	(DATSTA)	ISO 8601: 2004	(S) TD	0,1
Orientation			C	0,1
Orientation uncertainty			(S) RE	0,1
Orientation value	(ORIENT)		(S) RE	1,1
Periodic date range			C	0,*
Date end	(PEREND)	ISO 8601: 2004	(S) TD	1,1
Date start	(PERSTA)	ISO 8601: 2004	(S) TD	1,1
Quality of vertical measurement	(QUASOU)	1 : depth known 2 : depth or least depth unknown 3 : doubtful sounding 4 : unreliable sounding 6 : least depth known	EN	0,*
Status	(STATUS)	1 : permanent 5 : periodic/intermittent 6 : reserved 9 : mandatory	EN	0,*
Technique of vertical measurement	(TECSOU)	1 : found by echo-sounder 3 : found by multi-beam 6 : swept by wire-drag 8 : swept by vertical acoustic system 9 : found by	EN	0,*

		electromagnetic sensor 13 : swept by side-scan sonar 15 : found by LIDAR		
Traffic flow	(TRAFIC)	1 : inbound 2 : outbound 3 : one-way 4 : two-way	EN	0,1
Vertical uncertainty	(<i>SOUACC</i>)		C	0,1
Uncertainty fixed			(S) RE	1,1
Uncertainty variable			(S) RE	0.1
Scale minimum	(SCAMIN)	See clause X.X	IN	0,1

INT 1 Reference: M 28.1

15.9.1 Recommended routes (see S-4 – B-435.4)

A recommended route is a route of undefined width, for the convenience of ships in transit, which is often marked by centreline buoys. (IMO Ships Routeing, 2010). IMO-designated recommended routes are listed in IMO publication “*Ships’ Routeing*” Part E. This type of routeing measure was adopted to include such features as the “transit routes” (through former minefields) in the entrances to the Baltic Sea. In contrast to recommended tracks (see clause **X.X**), there is usually ample sea-room for vessels to keep well starboard (to the right) of the centreline.

If it is required to encode the centreline of a recommended route, it must be done using the feature **Recommended Route Centreline**.

Remarks:

- The attribute **depth range minimum value** is used to encode the shallowest depth on the route, where known.
- In the case of a recommended route centreline, only one value of orientation is encoded (in the complex attribute **orientation**); the other value can be deduced (that is, the value in **orientation (orientation value)** + 180 degrees). The value of orientation encoded on **orientation (orientation value)** should be the value of the bearing from seaward. If it is not possible to define a seaward direction, the value that is less than 180° should be used.
- When the traffic flow is one way (attribute **traffic flow** = 1, 2 or 3), the resultant direction of the line (accounting for the direction of digitising and any subsequent reversal of the line) associated with the **Recommended Route Centreline** must be the same as the direction of traffic flow, in order to ensure the correct representation in the ECDIS of the direction to be followed.

Distinction: Recommended track; recommended traffic lane part.

Feature/Information associations							
Type	Association Name	Association Ends					
		Class	Role	Mult	Class	Role	Mult
Aggr	Range System Aggregation	Recommended Route Centreline	Component of	1,*	Range System	Consists of	0,1

15.10 Two-way route part

IHO Definition: **TWO-WAY ROUTE PART.** A two-way route part is an area of a two-way route within which traffic flow is generally along one bearing (and possibly its reciprocal). (S-57 Edition 3.1, Appendix A – Chapter 1, Page 1.193, November 2000).

S-101 Geo Feature: Two-way route part (TWRTPT)

Primitives: Surface

Real World

Paper Chart Symbol

ECDIS Symbol

S-101 Attribute	S-57 Acronym	Allowable Encoding Value	Type	Multiplicity
Category of recommended track	(CATTRK)	1 : based on a system of fixed marks 2 : not based on a system of fixed marks	EN	0,1
Depth range minimum value	(DRVAL1)		RE	0,1
Fixed date range			C	0,1
Date end	(DATEND)	ISO 8601: 2004	(S) TD	0,1
Date start	(DATSTA)	ISO 8601: 2004	(S) TD	0,1
Orientation			C	1,1
Orientation uncertainty			(S) RE	0,1
Orientation value	(ORIENT)		(S) RE	1,1
Quality of vertical measurement	(QUASOU)	1 : depth known 2 : depth or least depth unknown 3 : doubtful sounding 4 : unreliable sounding 6 : least depth known	EN	0,*
Status	(STATUS)	1 : permanent 3 : recommended 6 : reserved 9 : mandatory	EN	0,*
Technique of vertical measurement	(TECSOU)	1 : found by echo-sounder 3 : found by multi-beam 5 : found by lead-line 6 : swept by wire-drag 8 : swept by vertical acoustic system 9 : found by electromagnetic sensor 13 : swept by side-scan sonar 15 : found by LIDAR	EN	0,*
Traffic flow	(TRAFIC)	1 : inbound 2 : outbound 3 : one-way 4 : two-way	EN	1,1
Vertical uncertainty	(SOUACC)		C	0,1

Uncertainty fixed			(S) RE	1,1
Uncertainty variable			(S) RE	0,1
Scale minimum	(SCAMIN)	See clause X.X	IN	0,1

INT 1 Reference: M 28.2

15.10.1 Two-way Routes (see S-4 – B-435.6)

A two way route is a route within defined limits inside which two way traffic is established, aimed at providing safe passage of ships through waters where navigation is difficult or dangerous (IMO Ships Routeing, 2010). It consists of one or more areas within which traffic flows in two directions along one bearing and/or its reciprocal. Such routes are established by regulatory authorities and may be adopted by IMO. IMO-designated two-way routes are listed in IMO publication “*Ships’ Routeing*” Part E. When it is required to encode these areas, this must be done using the feature **Two-way Route Part**. These route parts will generally be two-way, but some may be restricted to one-way traffic flow.

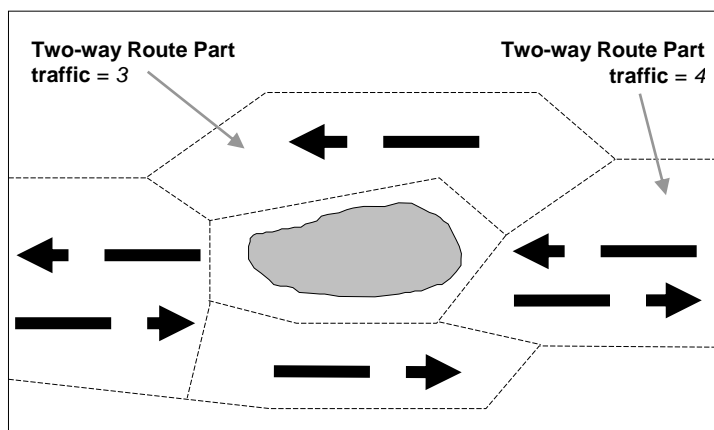

One-way traffic flow in a two-way route

If it is required to encode a two-way route with one-way sections, separate **Two-way Route Part** features must be encoded for the different parts, with attribute **traffic flow** = 3 (one-way) or 4 (two-way). In one-way sections, the mandatory complex attribute **orientation** must indicate the true direction of traffic flow, not its reciprocal. In two-way sections, **orientation** may indicate either direction of traffic flow.

Remarks:

- The orientation of the two-way route part is defined by the centreline of the part and is related to the general direction of the two-way route.
- The attribute **depth range minimum value** is used to encode the shallowest depth on the part, where required.
- To encode a complete Two-way route, the **Two-way Route Part** features may be associated with the feature **Two-Way Route** (see clause X.X) using the associations **Two-Way Route Aggregation** (see clause X.X) and **Aids to Navigation** (see clause X.X). Where it is required to indicate the name of a complete two-way route, this should be done using the complex attribute **feature name** for the **Two-way Route** feature. Where it is required to encode textual information for the DW, this should be done using an associated instance of the information class **Nautical Information** (see clause X.X), complex attribute **information**.
- All **Two-way Route Part** features comprising a complete two-way route must have the same value populated for the attribute **scale minimum** (see clause X.X).
- Two-way routes may be included with other routeing measures such as traffic separation schemes to comprise a complete traffic routeing system. To encode the relationship between routeing measures, the feature defining each routeing measure within the system (or the relevant feature if the routeing measure consists of a single feature) may be associated with the feature **Traffic Separation Scheme** (see clause X.X) using the **Traffic Separation Scheme Aggregation** (see clause X.X) to form a hierarchical relationship. The individual elements comprising different routeing measures must not be collected into a single **Traffic Separation Scheme** feature.

Distinction: Deep Water route part; recommended traffic lane part; traffic separation scheme lane part.

Feature/Information associations							
Type	Association Name	Association Ends					
		Class	Role	Mult	Class	Role	Mult
Aggr	Two-Way Route Aggregation	Two-Way Route Part	Consists of	2,*	Two-Way Route	Component of	0,1
Aggr	Traffic Separation Scheme Aggregation	Two-Way Route Part	Consists of	1,*	Traffic Separation Scheme	Component of	0,1

15.11 Two-way route

IHO Definition: **TWO-WAY ROUTE.** A route within defined limits inside which two way traffic is established, aimed at providing safe passage of ships through waters where navigation is difficult or dangerous. (IMO Ships' Routeing, 2010).

S-101 Geo Feature: Two-way route

Primitives: None

Real World

Paper Chart Symbol

ECDIS Symbol

S-101 Attribute	S-57 Acronym	Allowable Encoding Value	Type	Multiplicity
Feature name			C	0,*
Display name			(S) BO	0,1
Language		ISO 639-3	(S) TE	0,1
Name	(OBJNAM) (NOBJNM)		(S) TE	1,1
Maximum permitted draught			RE	0,1

INT 1 Reference: M 28.2

15.11.1 Two-way routes (see S4 – B-435.6)

To define the complete two-way system, the **Two-Way Route Part** features must be collected using the named aggregation feature **Two-Way Route**.

Remarks:

- The name of the two-way route must be populated using the complex attribute **feature name**.
- Where it is required to populate textual information for the two-way route, this should be done using an associated instance of the information class **Nautical Information** (see clause X.X), complex attribute **information**, or if the information is considered essential for safe navigation, using a **Caution Area** feature (see clause X.X).

Distinction: Deep Water route; fairway system; traffic separation scheme.

Feature/Information associations

Type	Association Name	Association Ends					
		Class	Role	Mult	Class	Role	Mult
Aggr	Two-Way Route Aggregation	Two-Way Route	Component of	0,1	Two-Way Route Part	Consists of	2,*
Aggr	Traffic Separation Scheme Aggregation	Two-Way Route	Consists of	1,*	Traffic Separation Scheme	Component of	0,1
Asso	Aids to Navigation Association	Two-Way Route	Component of	0,1	Beacon Cardinal, Beacon Isolated Danger, Beacon Lateral, Beacon Safe Water, Beacon Special Purpose/General, Buoy Cardinal, Buoy	Consists of	1,*

					Emergency Wreck Marking, Buoy Isolated Danger, Buoy Lateral, Buoy Safe Water, Buoy Special Purpose/General, Daymark, Light Float, Light Vessel, Landmark, Pile		
--	--	--	--	--	---	--	--

15.12 Recommended traffic lane part

IHO Definition: **RECOMMENDED TRAFFIC LANE PART.** A traffic flow pattern indicating a recommended directional movement of traffic where it is impractical or unnecessary to adopt an established direction of traffic flow. (IMO Ships' Routeing, 2010).

S-101 Geo Feature: Recommended traffic lane part (RCTLPT)

Primitives: Point, Surface

Real World

Paper Chart Symbol

ECDIS Symbol

S-101 Attribute	S-57 Acronym	Allowable Encoding Value	Type	Multiplicity
Fixed date range			C	0,1
Date end	(DATEND)	ISO 8601: 2004	(S) TD	0,1
Date start	(DATSTA)	ISO 8601: 2004	(S) TD	0,1
Orientation			C	1,1
Orientation uncertainty			(S) RE	0,1
Orientation value	(ORIENT)		(S) RE	1,1
Status	(STATUS)	1 : permanent 6 : reserved 9 : mandatory	EN	0,*
Scale minimum	(SCAMIN)	See clause X.X	IN	0,1

INT 1 Reference: M 26.1-2

15.12.1 Recommended traffic lane part (see S-4 – B-435.5)

Recommended direction of traffic flow is a traffic flow pattern indicating a recommended directional movement of traffic where it is impractical or unnecessary to adopt an established direction of traffic flow. (IMO Ships' Routeing, 2010). IMO-designated recommended directions of traffic flow are listed in IMO publication "Ships' Routeing" Part E. Several hydrographic offices, in consultation with their Ministries of Transport, have added recommended directions in areas such as the outer approaches to major ports in order to show the best routes for crossing traffic or to minimise the risk of head-on encounters.

The feature **Recommended Traffic Lane Part** must be used, where required, to encode areas with a recommended direction of traffic flow which is generally along one bearing:

- between two TSS (INT1 – M 26.1);
- in the entrance area of a TSS; or
- along the outside of a Deep Water route (INT1 – M 26.2).

Remarks:

- When the area is not defined, a point feature should be encoded.
- The orientation of the recommended traffic lane part is defined by the centreline of the part and is related to the general direction of traffic flow in the recommended traffic lane.

Distinction:

15.13 Deep water route centreline

IHO Definition: **DEEP WATER ROUTE CENTRELINE.** The Deep Water route centreline indicates the centreline of a route, the width of which is not explicitly defined. (S-57 Edition 3.1, Appendix A – Chapter 1, Page 1.49, November 2000).

S-101 Geo Feature: Deep water route centerline (DWRCTL)

Primitives: Curve

<i>Real World</i>	<i>Paper Chart Symbol</i>	<i>ECDIS Symbol</i>
-------------------	---------------------------	---------------------

S-101 Attribute	S-57 Acronym	Allowable Encoding Value	Type	Multiplicity
Category of recommended track	(CATTRK)	1 : based on a system of fixed marks 2 : not based on a system of fixed marks	EN	1,1
Category of traffic separation scheme	(CATTSS)	1 : IMO – adopted 2 : not IMO – adopted	EN	0,1
Depth range minimum value	(DRVAL1)		RE	0,1
Feature name			C	0,*
Display name			(S) BO	0,1
Language		ISO 639-3	(S) TE	0,1
Name	(OBJNAM) (NOBJNM)		(S) TE	1,1
Fixed date range			C	0,1
Date end	(DATEND)	ISO 8601: 2004	(S) TD	0,1
Date start	(DATSTA)	ISO 8601: 2004	(S) TD	0,1
Orientation			C	1,1
Orientation uncertainty			(S) RE	0,1
Orientation value	(ORIENT)		(S) RE	1,1
Quality of vertical measurement	(QUASOU)	1 : depth known 2 : depth or least depth unknown 3 : doubtful sounding 4 : unreliable sounding 6 : least depth known 7 : least depth unknown, safe clearance at value shown	EN	0,*
Status	(STATUS)	1 : permanent 3 : recommended 6 : reserved 9 : mandatory	EN	0,*
Technique of vertical measurement	(TECSOU)	1 : found by echo-sounder 3 : found by multi-beam 5 : found by lead-line 6 : swept by wire-drag 8 : swept by vertical acoustic system 9 : found by	EN	0,*

		electromagnetic sensor 13 : swept by side-scan sonar 15 : found by LIDAR		
Traffic flow	(TRAFIC)	1 : inbound 2 : outbound 3 : one-way 4 : two-way	EN	1,1
Vertical uncertainty	(SOUACC)		C	0,1
Uncertainty fixed			(S) RE	1,1
Uncertainty variable			(S) RE	0.1
Scale minimum	(SCAMIN)	See clause X.X	IN	0,1

INT 1 Reference: M 27.3

15.13.1 Deep Water routes centrelines (see S-4 – B-435.3)

A complete Deep Water route (DW) consists of one or more areas within which the flow of traffic either follows one defined direction for one-way traffic, or follows one defined direction and its reciprocal for two-way traffic.

If it is required to encode the centreline of a Deep Water route, the width of which is not explicitly defined, it must be done using the feature **Deep Water Route Centreline**.

Remarks:

- In the case of a deep water route centreline, only one value of orientation is encoded (in the complex attribute **orientation**); the other value can be deduced (that is, the value in **orientation (orientation value)** + 180 degrees). The value of orientation encoded on the complex attribute **orientation (orientation value)** should be the value of the bearing from seaward. If it is not possible to define a seaward direction, the value that is less than 180° should be used.
- When the traffic flow is one way (attribute **traffic flow** = 1, 2 or 3), the resultant direction of the line (accounting for the direction of digitising and any subsequent reversal of the line) associated with the **Deep Water Route Centreline** must be the same as the direction of traffic flow, in order to ensure the correct representation in the ECDIS of the direction to be followed.
- The complex attribute **feature name** should only be used if the individual feature is not included in a collection feature (see clause X.X).
- To encode a complete Deep Water route, the **Deep Water Route Centreline**, **Deep Water Route Part** features, and the navigational aids features (if they are stated in the regulation defining the DW), may be associated with the feature **Deep Water Route** (see clause X.X) using the associations **Deep Water Route Aggregation** (see clause X.X) and **Aids to Navigation** (see clause X.X). Where it is required to indicate the name of a complete DW, this should be done using the complex attribute **feature name** for the **Deep Water Route** feature. Where it is required to encode textual information for the DW, this should be done using an associated instance of the information class **Nautical Information** (see clause X.X), complex attribute **information**.
- Deep Water routes, unlike dredged areas, are likely to be designated in offshore waters outside the immediate supervision of harbour authorities (although some do form the outer approaches to deep water ports). No least depth quoted can be fully guaranteed in most cases. Least depths within the route should be encoded by soundings as elsewhere on the ENC dataset so that the navigator will not assume that the depths are continually monitored. However, in those cases where a hydrographic authority feels confident to guarantee the existence of a minimum depth of water in a DW route, it must be populated using the attribute **depth range minimum value**.
- Deep water routes may be included with other routing measures such as traffic separation schemes to comprise a complete traffic routing system. To encode the relationship between routing measures, the feature defining each routing measure within the system (or the relevant feature if the routing measure consists of a single feature) may be associated with the feature **Traffic Separation Scheme** (see clause X.X) using the **Traffic Separation Scheme Aggregation** (see clause X.X) to form a hierarchical relationship. The individual elements comprising different routing measures must not be collected into a single **Traffic Separation Scheme** feature.
- IMO-designated Deep Water routes are listed in IMO publication “Ships’ Routing” Part C.

Distinction: Deep Water route part.

Feature/Information associations							
Type	Association Name	Association Ends					
		Class	Role	Mult	Class	Role	Mult
Aggr	Deep Water Route Aggregation	Deep Water Route Centreline	Consists of	2,*	Deep Water Route	Component of	0,1
Aggr	Traffic Separation Scheme Aggregation	Deep Water Route Centreline	Consists of	1,*	Traffic Separation Scheme	Component of	0,1

15.14 Deep water route part

IHO Definition: DEEP WATER ROUTE PART. An area of a deep water route within which ships proceed in the same direction.				
S-101 Geo Feature: Deep water route part (DWRTP)				
Primitives: Surface				
<i>Real World</i>		<i>Paper Chart Symbol</i>		<i>ECDIS Symbol</i>
S-101 Attribute	S-57 Acronym	Allowable Encoding Value	Type	Multiplicity
Category of traffic separation scheme	(CATTSS)	1 : IMO – adopted 2 : not IMO – adopted	EN	0,1
Depth range minimum value	(DRVAL1)		RE	1,1
Feature name			C	0,*
Display name			(S) BO	0,1
Language		ISO 639-3	(S) TE	0,1
Name	(OBJNAM) (NOBJNM)		(S) TE	1,1
Fixed date range			C	0,1
Date end	(DATEND)	ISO 8601: 2004	(S) TD	0,1
Date start	(DATSTA)	ISO 8601: 2004	(S) TD	0,1
Orientation			C	1,1
Orientation uncertainty			(S) RE	0,1
Orientation value	(ORIENT)		(S) RE	1,1
Quality of vertical measurement	(QUASOU)	1 : depth known 2 : depth or least depth unknown 3 : doubtful sounding 4 : unreliable sounding 6 : least depth known 7 : least depth unknown, safe clearance at value shown	EN	0,*
Restriction	(RESTRN)	1 : anchoring prohibited 2 : anchoring restricted 3 : fishing prohibited 4 : fishing restricted 5 : trawling prohibited 6 : trawling restricted 8 : entry restricted 9 : dredging prohibited 10 : dredging restricted 11 : diving prohibited 12 : diving restricted 13 : no wake 16 : discharging prohibited 17 : discharging restricted 18 : industrial or mineral exploration/development prohibited	EN	0,*

		19 : industrial or mineral exploration/development restricted 20 : drilling prohibited 21 : drilling restricted 22 : removal of historical artefacts prohibited 23 : cargo transshipment (lightening) prohibited 24 : dragging prohibited 25 : stopping prohibited 27 : speed restricted		
Status	(STATUS)	1 : permanent 3 : recommended 6 : reserved 9 : mandatory 28 : buoyed	EN	0,*
Technique of vertical measurement	(TECSOU)	1 : found by echo-sounder 3 : found by multi-beam 5 : found by lead-line 6 : swept by wire-drag 8 : swept by vertical acoustic system 9 : found by electromagnetic sensor 13 : swept by side-scan sonar 15 : found by LIDAR	EN	0,*
Traffic flow	(TRAFIC)	1 : inbound 2 : outbound 3 : one-way 4 : two-way	EN	1,1
Vertical uncertainty	(SOUACC)		C	0,1
Uncertainty fixed			(S) RE	1,1
Uncertainty variable			(S) RE	0.1
Scale minimum	(SCAMIN)	See clause X.X	IN	0,1

INT 1 Reference: M 27.1-2

15.14.1 Deep Water route parts (see S-4 – B-435; B-435.3 and B-436.3)

A complete Deep Water route (DW) consists of one or more areas within which the flow of traffic either follows one defined direction for one-way traffic, or follows one defined direction and its reciprocal for two-way traffic.

If it is required to encode these areas, this must be done using the feature **Deep Water Route Part**.

Remarks:

- The complex attribute **feature name** should only be used if the individual feature is not aggregated in a collection feature or is the most representative feature in a collection feature (see clause X.X).
- The route must be covered by **Depth Area** features.
- A Deep Water route part may overlap a **Traffic Separation Scheme Lane Part** feature.
- To encode a complete Deep Water route, the **Deep Water Route Centreline**, **Deep Water Route Part** features, and the navigational aids features (if they are stated in the regulation defining the DW), may be associated with the feature **Deep Water Route** (see clause X.X) using the associations **Deep Water Route Aggregation** (see clause X.X) and **Aids to Navigation** (see clause X.X). Where it is required to indicate the name of a complete DW, this should be done using the complex attribute **feature name** for the **Deep Water Route** feature. Where it is required to encode textual information for the DW, this should be done using an associated instance of the information class **Nautical Information** (see clause X.X), complex attribute **information**.
- Deep Water routes, unlike dredged areas, are likely to be designated in offshore waters outside the immediate supervision of harbour authorities (although some do form the outer approaches to deep water ports). No least depth quoted can be fully guaranteed in most cases. Least depths within the route should

be encoded by soundings as elsewhere on the ENC dataset so that the navigator will not assume that the depths are continually monitored. However, in those cases where a hydrographic authority feels confident to guarantee the existence of a minimum depth of water in a DW route, it must be populated using the attribute **depth range minimum value**.

- The orientation of the Deep Water route part is defined by the centreline of the part and is related to the general direction of traffic flow in the Deep Water route.
- Deep water routes may be included with other routing measures such as traffic separation schemes to comprise a complete traffic routing system. To encode the relationship between routing measures, the feature defining each routing measure within the system (or the relevant feature if the routing measure consists of a single feature) may be associated with the feature **Traffic Separation Scheme** (see clause X.X) using the **Traffic Separation Scheme Aggregation** (see clause X.X) to form a hierarchical relationship. The individual elements comprising different routing measures must not be collected into a single **Traffic Separation Scheme** feature.
- IMO-designated Deep Water routes are listed in IMO publication “*Ships’ Routing*” Part C.

Distinction: Deep Water route centreline; two-way route part.

Feature/Information associations							
Type	Association Name	Association Ends					
		Class	Role	Mult	Class	Role	Mult
Aggr	Deep Water Route Aggregation	Deep Water Route Part	Consists of	2,*	Deep Water Route	Component of	0,1
Aggr	Traffic Separation Scheme Aggregation	Deep Water Route Part	Consists of	1,*	Traffic Separation Scheme	Component of	0,1

15.15 Deep Water route

IHO Definition: **DEEP WATER ROUTE.** A route within defined limits which has been accurately surveyed for clearance of sea bottom and submerged obstacles as indicated on the chart. (IMO Ships' Routeing, 2010).

S-101 Geo feature: Deep Water Route

Primitives: None

Real World

Paper Chart Symbol

ECDIS Symbol

S-101 Attribute	S-57 Acronym	Allowable Encoding Value	Type	Multiplicity
Category of traffic separation scheme	(CATTSS)	1 : IMO – adopted 2 : not IMO – adopted	EN	0,1
Feature name			C	0,*
Display name			(S) BO	0,1
Language		ISO 639-3	(S) TE	0,1
Name	(OBJNAM) (NOBJNM)		(S) TE	1,1

INT 1 Reference: M 27.1-3

15.15.1 Deep Water routes (see S4 – B-435.3)

To define the complete Deep Water route (DW) system, the features **Deep Water Route Centreline**, **Deep Water Route Part** and any associated navigation aids must be associated with the feature **Deep Water Route** using the associations **Deep Water Route Aggregation** (see clause X.X) and **Aids to Navigation** (see clause X.X)

Remarks:

- The name of the DW must be populated using the complex attribute **feature name**.
- Where it is required to populate textual information for the DW, this should be done using an associated instance of the information class **Nautical Information** (see clause X.X), complex attribute **information**, or if the information is considered essential for safe navigation, using a **Caution Area** feature (see clause X.X).

Distinction: Fairway system; traffic separation scheme; two-way route.

Feature/Information associations

Type	Association Name	Association Ends					
		Class	Role	Mult	Class	Role	Mult
Aggr	Deep Water Route Aggregation	Deep Water Route	Component of	0,1	Deep Water Route Centreline, Deep Water Route Part	Consists of	2,*
Aggr	Traffic Separation Scheme Aggregation	Deep Water Route	Consists of	1,*	Traffic Separation Scheme	Component of	0,1
Asso	Aids to Navigation Association	Deep Water Route	Component of	0,1	Beacon Cardinal, Beacon Isolated Danger, Beacon Lateral, Beacon Safe	Consists of	1,*

					Water, Beacon Special Purpose/General, Buoy Cardinal, Buoy Emergency Wreck Marking, Buoy Installation, Buoy Isolated Danger, Buoy Lateral, Buoy Safe Water, Buoy Special Purpose/General, Daymark, Light Float, Light Vessel, Landmark, Pile		
--	--	--	--	--	---	--	--

15.16 Inshore traffic zone

IHO Definition: **INSHORE TRAFFIC ZONE.** A routing measure comprising a designated area between the landward boundary of a traffic separation scheme and the adjacent coast, to be used in accordance with the provisions of the International Regulations for Preventing Collisions as Sea. (Adapted from IMO Ships' Routing, 2010).

S-101 Geo Feature: Inshore traffic zone (ISTZNE)

Primitives: Surface

<i>Real World</i>	<i>Paper Chart Symbol</i>	<i>ECDIS Symbol</i>
-------------------	---------------------------	---------------------

S-101 Attribute	S-57 Acronym	Allowable Encoding Value	Type	Multiplicity
Fixed date range			C	0,1
Date end	(DATEND)	ISO 8601: 2004	(S) TD	0,1
Date start	(DATSTA)	ISO 8601: 2004	(S) TD	0,1
Restriction	(RESTRN)	1 : anchoring prohibited 2 : anchoring restricted 3 : fishing prohibited 4 : fishing restricted 5 : trawling prohibited 6 : trawling restricted 8 : entry restricted 9 : dredging prohibited 10 : dredging restricted 11 : diving prohibited 12 : diving restricted 13 : no wake 16 : discharging prohibited 17 : discharging restricted 18 : industrial or mineral exploration/development prohibited 19 : industrial or mineral exploration/development restricted 20 : drilling prohibited 21 : drilling restricted 22 : removal of historical artefacts prohibited 23 : cargo transhipment (lightening) prohibited 24 : dragging prohibited 25 : stopping prohibited 27 : speed restricted	EN	0,*
Status	(STATUS)	1 : permanent 3 : recommended 6 : reserved 9 : mandatory 16 : watched 17 : un-watched	EN	0,*
Scale minimum	(SCAMIN)	See clause X.X	IN	0,1

INT 1 Reference: M 25.1, 25.2

15.16.1 Inshore traffic zones (see S-4 – B-435.1)

The feature **Inshore Traffic Zone** must only be used to encode the designated area between the landward boundary of a traffic separation scheme and the adjacent coast.

Remarks:

- Inshore traffic zones are used to exclude most classes of through traffic. Traffic in an inshore traffic zone is separated from traffic in the adjacent traffic lane by either a separation zone or a separation line (see clauses **X.X** and **X.X**). An inshore traffic zone may be adjacent to a precautionary area (see clause **X.X**).

Distinction: Traffic separation scheme crossing; traffic separation scheme lane part; traffic separation scheme roundabout; traffic separation zone; precautionary area.

Feature/Information associations

Type	Association Name	Association Ends					
		Class	Role	Mult	Class	Role	Mult
Aggr	Traffic Separation Scheme Aggregation	Inshore Traffic Zone	Consists of	1,*	Traffic Separation Scheme	Component of	0,1

15.17 Precautionary area

IHO Definition: PRECAUTIONARY AREA. A routing measure comprising an area within defined limits where ships must navigate with particular caution and within which the direction of traffic flow may be recommended. (IMO Ships' Routing, 2010).				
S-101 Geo Feature: Precautionary area (PRCARE)				
Primitives: Point, Surface				
<i>Real World</i>		<i>Paper Chart Symbol</i>		<i>ECDIS Symbol</i>
S-101 Attribute	S-57 Acronym	Allowable Encoding Value	Type	Multiplicity
Category of traffic separation scheme	(CATTSS)	1 : IMO – adopted 2 : not IMO – adopted	EN	0,1
Feature name			C	0,*
Display name			(S) BO	0,1
Language		ISO 639-3	(S) TE	0,1
Name	(OBJNAM) (NOBJNM)		(S) TE	1,1
Fixed date range			C	0,1
Date end	(DATEND)	ISO 8601: 2004	(S) TD	0,1
Date start	(DATSTA)	ISO 8601: 2004	(S) TD	0,1
Restriction	(RESTRN)	1 : anchoring prohibited 2 : anchoring restricted 3 : fishing prohibited 4 : fishing restricted 5 : trawling prohibited 6 : trawling restricted 8 : entry restricted 9 : dredging prohibited 10 : dredging restricted 11 : diving prohibited 12 : diving restricted 13 : no wake 14 : area to be avoided 16 : discharging prohibited 17 : discharging restricted 18 : industrial or mineral exploration/development prohibited 19 : industrial or mineral exploration/development restricted 20 : drilling prohibited 21 : drilling restricted 22 : removal of historical artefacts prohibited 23 : cargo transshipment (lightening) prohibited 24 : dragging prohibited 25 : stopping prohibited 27 : speed restricted	EN	0,*
Status	(STATUS)	1 : permanent	EN	0,*

		9 : mandatory 28 : buoyed		
Scale minimum	(SCAMIN)	See clause X.X	IN	0,1
<p><u>INT 1 Reference:</u> M 16, 24</p> <p>15.17.1 Precautionary areas (see S-4 – B-435.2)</p> <p>Precautionary areas are commonly designated by IMO for certain areas of converging or crossing traffic, usually in association with traffic separation schemes. If it is required to encode such areas, it must be done using the feature Precautionary Area.</p> <p><u>Remarks:</u></p> <ul style="list-style-type: none"> To encode the relevant cautionary information, this must be done using an associated instance of the information class Nautical Information (see clause X.X), complex attribute information. A Precautionary Area feature may overlap other features encoded for the traffic separation scheme (for example Traffic Separation Scheme Roundabout, Traffic Separation Scheme Lane Part, Traffic Separation Scheme Crossing). <p><u>Distinction:</u> Caution area; deep water route part; inshore traffic zone; restricted area navigational; restricted area regulatory; traffic separation scheme boundary; traffic separation scheme crossing; traffic separation scheme lane part; traffic separation scheme roundabout; traffic separation zone; two-way route part.</p>				

Feature/Information associations							
Type	Association Name	Association Ends					
		Class	Role	Mult	Class	Role	Mult
Aggr	Traffic Separation Scheme Aggregation	Precautionary Area	Consists of	1,*	Traffic Separation Scheme	Component of	0,1
Asso	Additional Information	Precautionary Area	Provides information	1,*	Nautical Information	Information provided for	0,1

15.18 Traffic separation scheme lane part

IHO Definition: TRAFFIC SEPARATION SCHEME LANE PART.				
A traffic separation scheme lane part is an area of a traffic lane in which the direction of flow of traffic is generally along one bearing. (Adapted from S-57 Edition 3.1, Appendix A – Chapter 1, Page 1.187, November 2000).				
S-101 Geo Feature: Traffic separation scheme lane part (TSSLPT)				
Primitives: Surface				
<i>Real World</i>	<i>Paper Chart Symbol</i>	<i>ECDIS Symbol</i>		
S-101 Attribute	S-57 Acronym	Allowable Encoding Value	Type	Multiplicity
Fixed date range			C	0,1
Date end	(DATEND)	ISO 8601: 2004	(S) TD	0,1
Date start	(DATSTA)	ISO 8601: 2004	(S) TD	0,1
Orientation			C	0,1
Orientation uncertainty			(S) RE	0,1
Orientation value	(ORIENT)		(S) RE	1,1
Restriction	(RESTRN)	1 : anchoring prohibited 2 : anchoring restricted 3 : fishing prohibited 4 : fishing restricted 5 : trawling prohibited 6 : trawling restricted 8 : entry restricted 9 : dredging prohibited 10 : dredging restricted 11 : diving prohibited 12 : diving restricted 13 : no wake 16 : discharging prohibited 17 : discharging restricted 18 : industrial or mineral exploration/development prohibited 19 : industrial or mineral exploration/development restricted 20 : drilling prohibited 21 : drilling restricted 22 : removal of historical artefacts prohibited 23 : cargo transshipment (lightening) prohibited 24 : dragging prohibited 25 : stopping prohibited 27 : speed restricted	EN	0,*
Status	(STATUS)	1 : permanent 3 : recommended 6 : reserved 9 : mandatory 28 : buoyed	EN	0,*

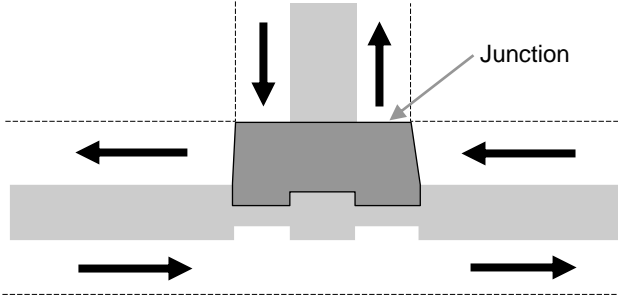
Scale minimum	(SCAMIN)	See clause X.X	IN	0,1
<p>INT 1 Reference: M 20.1-3, 22</p> <p>15.18.1 Traffic separation scheme lanes (see S-4 – B-435.1)</p> <p>A traffic lane is an area within defined limits in which one-way traffic flow is established. Natural obstacles, including those forming separation zones, may constitute a boundary. (IHO Dictionary – S-32). A complete traffic separation scheme lane consists of one or more areas within which the flow of traffic follows one defined direction. If it is required to encode these areas, this must be done using the feature Traffic Separation Scheme Lane Part.</p> <p>Remarks:</p> <ul style="list-style-type: none"> The complex attribute orientation is mandatory for all Traffic Separation Scheme Lane Part features, unless the part is a junction. At junctions, other than crossings and roundabouts, a separate Traffic Separation Scheme Lane Part feature must be encoded. For this feature, the complex attribute orientation must be omitted, in order to avoid implying that one lane has priority over another (see INT1 – M22). Warning text may be encoded using an associated instance of the information class Nautical Information (see clause X.X), complex attribute information. In some cases, a precautionary area is established where routes meet or cross (see clause X.X). <div style="text-align: center;">  </div> <ul style="list-style-type: none"> The orientation of the traffic separation scheme lane part is defined by the centreline of the part and is related to the general direction of traffic flow in the traffic separation lane. <p>Distinction: Recommended traffic lane part; traffic separation line; traffic separation scheme boundary; traffic separation scheme crossing; traffic separation scheme roundabout; traffic separation zone.</p>				

Feature/Information associations

Type	Association Name	Association Ends					
		Class	Role	Mult	Class	Role	Mult
Aggr	Traffic Separation Scheme Aggregation	Traffic Separation Scheme Lane Part	Consists of	1,*	Traffic Separation Scheme	Component of	0,1

15.19 Traffic separation zone

IHO Definition: **TRAFFIC SEPARATION ZONE.** A zone separating the lanes in which ships are proceeding in opposite or nearly opposite directions; or separating a traffic lane from an adjacent sea area; or separating traffic lanes designated for particular classes of ships proceeding in the same direction. (IMO Ships' Routeing, 2010).

S-101 Geo Feature: Traffic separation zone (TSEZNE)

Primitives: Surface

<i>Real World</i>	<i>Paper Chart Symbol</i>	<i>ECDIS Symbol</i>
-------------------	---------------------------	---------------------

S-101 Attribute	S-57 Acronym	Allowable Encoding Value	Type	Multiplicity
Fixed date range			C	0,1
Date end	(DATEND)	ISO 8601: 2004	(S) TD	0,1
Date start	(DATSTA)	ISO 8601: 2004	(S) TD	0,1
Status	(STATUS)	1 : permanent 3 : recommended 9 : mandatory 28 : buoyed	EN	0,*
Scale minimum	(SCAMIN)	See clause X.X	IN	0,1

INT 1 Reference: M 13, 20.1, 20.3, 21

15.19.1 Traffic separation zones (see S-4 – B-435.1 and B-436.3)

The feature **Traffic Separation Zone** must only be used to encode the separation areas between two traffic lanes, or of one traffic lane and one inshore traffic zone, or to encode the centre part of a roundabout.

Remarks:

- No remarks.

Distinction: Traffic separation line; traffic separation scheme boundary; traffic separation scheme crossing; traffic separation scheme lane part; traffic separation scheme roundabout.

Feature/Information associations							
Type	Association Name	Association Ends					
		Class	Role	Mult	Class	Role	Mult
Aggr	Traffic Separation Scheme Aggregation	Traffic Separation Zone	Consists of	1,*	Traffic Separation Scheme	Component of	0,1

15.20 Traffic separation line

IHO Definition: **TRAFFIC SEPARATION LINE.** A line separating the lanes in which ships are proceeding in opposite, or nearly opposite directions; or separating a traffic lane from an adjacent sea area; or separating traffic lanes designated for particular classes of ships proceeding in the same direction. (IMO Ships' Routeing, 2010).

S-101 Geo Feature: Traffic separation line (TSELNE)

Primitives: Curve

Real World

Paper Chart Symbol

ECDIS Symbol

S-101 Attribute	S-57 Acronym	Allowable Encoding Value	Type	Multiplicity
Fixed date range			C	0,1
Date end	(DATEND)	ISO 8601: 2004	(S) TD	0,1
Date start	(DATSTA)	ISO 8601: 2004	(S) TD	0,1
Status	(STATUS)	1 : permanent 3 : recommended 9 : mandatory 28 : buoyed	EN	0,*
Scale minimum	(SCAMIN)	See clause X.X	IN	0,1

INT 1 Reference: M 12

15.20.1 Traffic separation line (see S-4 – B-435.1 and B-436.3)

The feature **Traffic Separation Line** must only be used to encode the common boundary of two traffic lanes, or of one traffic lane and one inshore traffic zone.

Remarks:

- No remarks.

Distinction: Traffic separation scheme boundary; traffic separation scheme crossing; traffic separation scheme lane part; traffic separation scheme roundabout; traffic separation zone.

Feature/Information associations

Type	Association Name	Association Ends					
		Class	Role	Mult	Class	Role	Mult
Aggr	Traffic Separation Scheme Aggregation	Traffic Separation Line	Consists of	1,*	Traffic Separation Scheme	Component of	0,1

15.21 Traffic separation scheme boundary

IHO Definition: **TRAFFIC SEPARATION SCHEME BOUNDARY.** The outer limit of a traffic lane part or a traffic separation scheme roundabout. (S-57 Edition 3.1, Appendix A – Chapter 1, Page 1.185, November 2000).

S-101 Geo Feature: **Traffic separation scheme boundary (TSSBND)**

Primitives: Curve

Real World

Paper Chart Symbol

ECDIS Symbol

S-101 Attribute	S-57 Acronym	Allowable Encoding Value	Type	Multiplicity
Fixed date range			C	0,1
Date end	(DATEND)	ISO 8601: 2004	(S) TD	0,1
Date start	(DATSTA)	ISO 8601: 2004	(S) TD	0,1
Status	(STATUS)	1 : permanent 3 : recommended 9 : mandatory 28 : buoyed	EN	0,*
Scale minimum	(SCAMIN)	See clause X.X	IN	0,1

INT 1 Reference: M 15

15.21.1 Traffic separation scheme boundaries (see S-4 – B-435.1)

The feature **Traffic Separation Scheme Boundary** must only be used to encode the outer limits of traffic lanes or traffic separation scheme roundabouts.

Remarks:

- **Traffic Separation Scheme Boundary** must not be used to encode the boundary between a traffic separation scheme lane or roundabout and a traffic separation zone; or a traffic separation zone and an inshore traffic zone.

Distinction: Traffic separation line; traffic separation scheme crossing; traffic separation scheme lane part; traffic separation scheme roundabout; traffic separation zone.

Feature/Information associations

Type	Association Name	Association Ends					
		Class	Role	Mult	Class	Role	Mult
Aggr	Traffic Separation Scheme Aggregation	Traffic Separation Boundary	Consists of	1,*	Traffic Separation Scheme	Component of	0,1

15.22 Traffic separation scheme crossing

IHO Definition: TRAFFIC SEPARATION SCHEME CROSSING. A defined area where traffic lanes cross. (S-57 Edition 3.1, Appendix A – Chapter 1, Page 1.186, November 2000).				
S-101 Geo Feature: Traffic separation scheme crossing (TSSCRS)				
Primitives: Surface				
<i>Real World</i>		<i>Paper Chart Symbol</i>		<i>ECDIS Symbol</i>
S-101 Attribute	S-57 Acronym	Allowable Encoding Value	Type	Multiplicity
Fixed date range			C	0,1
Date end	(DATEND)	ISO 8601: 2004	(S) TD	0,1
Date start	(DATSTA)	ISO 8601: 2004	(S) TD	0,1
Restriction	(RESTRN)	1 : anchoring prohibited 2 : anchoring restricted 3 : fishing prohibited 4 : fishing restricted 5 : trawling prohibited 6 : trawling restricted 8 : entry restricted 9 : dredging prohibited 10 : dredging restricted 11 : diving prohibited 12 : diving restricted 13 : no wake 16 : discharging prohibited 17 : discharging restricted 18 : industrial or mineral exploration/development prohibited 19 : industrial or mineral exploration/development restricted 20 : drilling prohibited 21 : drilling restricted 22 : removal of historical artefacts prohibited 23 : cargo transshipment (lightening) prohibited 24 : dragging prohibited 25 : stopping prohibited 27 : speed restricted	EN	0,*
Status	(STATUS)	1 : permanent 3 : recommended 6 : reserved 9 : mandatory	EN	0,*
Scale minimum	(SCAMIN)	See clause X.X	IN	0,1
INT 1 Reference: M 23				
15.22.1 Traffic separation scheme crossing (see S-4 – B-435.1)				
The feature Traffic Separation Scheme Crossing must only be used to encode the area where at least four traffic lanes cross.				
Remarks:				

- Junctions other than crossings and roundabouts should be encoded using the feature **Traffic Separation Scheme Lane Part** (see clause X.X).
- A **Traffic Separation Scheme Crossing** feature must not overlap a **Traffic Separation Zone** feature at its centre.
- In some cases, a precautionary area is established where routes meet or cross (see clause X.X).

Distinction: Traffic separation line; traffic separation scheme boundary; traffic separation scheme lane part; traffic separation scheme roundabout; traffic separation zone.

Feature/Information associations

Type	Association Name	Association Ends					
		Class	Role	Mult	Class	Role	Mult
Aggr	Traffic Separation Scheme Aggregation	Traffic Separation Scheme Crossing	Consists of	1,*	Traffic Separation Scheme	Component of	0,1

15.23 Traffic separation scheme roundabout

IHO Definition: **TRAFFIC SEPARATION SCHEME ROUNDABOUT.** A routeing measure comprising a separation point or circular separation zone and a circular traffic lane within defined limits. Traffic within the roundabout is separated by moving in a counter clockwise direction around the separation point or zone. (IMO Ships' Routeing, 2010).

S-101 Geo Feature: Traffic separation scheme roundabout (TSSRON)

Primitives: Surface

<i>Real World</i>	<i>Paper Chart Symbol</i>	<i>ECDIS Symbol</i>		
S-101 Attribute	S-57 Acronym	Allowable Encoding Value	Type	Multiplicity
Fixed date range			C	0,1
Date end	(DATEND)	ISO 8601: 2004	(S) TD	0,1
Date start	(DATSTA)	ISO 8601: 2004	(S) TD	0,1
Restriction	(RESTRN)	1 : anchoring prohibited 2 : anchoring restricted 3 : fishing prohibited 4 : fishing restricted 5 : trawling prohibited 6 : trawling restricted 8 : entry restricted 9 : dredging prohibited 10 : dredging restricted 11 : diving prohibited 12 : diving restricted 13 : no wake 16 : discharging prohibited 17 : discharging restricted 18 : industrial or mineral exploration/development prohibited 19 : industrial or mineral exploration/development restricted 20 : drilling prohibited 21 : drilling restricted 22 : removal of historical artefacts prohibited 23 : cargo transshipment (lightening) prohibited 24 : dragging prohibited 25 : stopping prohibited 27 : speed restricted	EN	0,*
Status	(STATUS)	1 : permanent 3 : recommended 6 : reserved 9 : mandatory	EN	0,*
Scale minimum	(SCAMIN)	See clause X.X	IN	0,1

INT 1 Reference: M 21

15.23.1 Traffic separation scheme roundabout (see S-4 – B-435.1)

The feature **Traffic Separation Scheme Roundabout** must only be used to encode the area in which traffic

moves in a counter clockwise direction around a specified point or zone.

Remarks:

- Junctions other than crossings and roundabouts should be encoded using the feature **Traffic Separation Scheme Lane Part** (see clause X.X).
- A **Traffic Separation Scheme Roundabout** feature must not overlap a **Traffic Separation Zone** feature at its centre.
- In some cases, a precautionary area is established where routes meet or cross (see clause X.X).

Distinction: Traffic separation line; traffic separation scheme boundary; traffic separation scheme crossing; traffic separation scheme lane part; traffic separation zone.

Feature/Information associations

Type	Association Name	Association Ends					
		Class	Role	Mult	Class	Role	Mult
Aggr	Traffic Separation Scheme Aggregation	Traffic Separation Scheme Roundabout	Consists of	1,*	Traffic Separation Scheme	Component of	0,1

15.24 Traffic separation scheme

IHO Definition: **TRAFFIC SEPARATION SCHEME.** A scheme which aims to reduce the risk of collision in congested and/or converging areas by separating traffic moving in opposite, or nearly opposite, directions. (IMO Ships' Routeing, 2010).

S-101 Geo Feature: Traffic separation scheme

Primitives: None

Real World

Paper Chart Symbol

ECDIS Symbol

S-101 Attribute	S-57 Acronym	Allowable Encoding Value	Type	Multiplicity
Category of traffic separation scheme	(CATTSS)	1 : IMO – adopted 2 : not IMO – adopted	EN	0,1
Feature name			C	0,*
Display name			(S) BO	0,1
Language		ISO 639-3	(S) TE	0,1
Name	(OBJNAM) (NOBJNM)		(S) TE	1,1
Maximum permitted draught			RE	0,1

INT 1 Reference: M 20.1-27.3, 29.1

15.24.1 Traffic separation schemes (see S4 – B-435.1-3)

If it is required to encode a traffic separation scheme (TSS), it must be done using:

- Deep Water routes (DW – a route within defined limits which has been accurately surveyed for clearance of sea bottom and submerged obstacles as indicated on the chart. (IMO Ships Routeing, 2010)). Deep Water routes are encoded using **Deep Water Route Centreline** and **Deep Water Route Part** features (see clauses X.X and X.X);
- **Inshore Traffic Zone** (see clause X.X);
- **Precautionary Area** (see clause X.X);
- **Traffic Separation Line, Traffic Separation Zone, Traffic Separation Scheme Boundary, Traffic Separation Scheme Crossing, Traffic Separation Scheme Lane Part, Traffic Separation Scheme Roundabout** (see clauses X.X to X.X); and
- Navigational aids features (see Sections XX and XX).

To define the complete traffic separation scheme system, these features must associated with the feature **Traffic Separation Scheme** using the association **Traffic Separation Scheme Aggregation** (see clause X.X).

Remarks:

- The name of the TSS must be populated using the complex attribute **feature name**.
- Where it is required to encode an IMO declared Area to be Avoided within a TSS, this must be done using the feature **Restricted Area Navigational** (see clause X.X), with attribute **restriction** = 14 (area to be avoided).
- Where it is required to populate textual information for the TSS, this should be done using an associated instance of the information class **Nautical Information** (see clause X.X), complex attribute **information**, or if the information is considered essential for safe navigation, using a **Caution Area** feature (see clause X.X).

Distinction: Deep Water route; fairway system; two-way route.

Feature/Information associations							
Type	Association Name	Association Ends					
		Class	Role	Mult	Class	Role	Mult
Aggr	Traffic Separation Scheme Aggregation	Traffic Separation Scheme	Component of	0,1	Beacon Cardinal, Beacon Isolated Danger, Beacon Lateral, Beacon Safe Water, Beacon Special Purpose/General, Buoy Cardinal, Buoy Emergency Wreck Marking, Buoy Isolated Danger, Buoy Lateral, Buoy Safe Water, Buoy Special Purpose/General, Caution Area, Deep Water Route, Deep Water Route Centreline, Daymark, Deep Water Route Part, Inshore Traffic Zone, Landmark, Light Float, Light Vessel, Pile, Precautionary Area, Restricted Area Navigational, Restricted Area Regulatory, Traffic Separation Line, Traffic Separation Scheme, Traffic Separation Scheme Boundary, Traffic Separation Scheme Crossing, Traffic Separation Scheme Lane Part, Traffic Separation Scheme Roundabout, Traffic Separation Zone, Two-Way Route, Two-Way Route Part	Consists of	1,*

15.25 Archipelagic Sea Lane area

IHO Definition: **ARCHIPELAGIC SEA LANE AREA.** Sea lanes designated by an archipelagic State for the passage of ships and aircraft. (IHO Dictionary – S-32).

S-101 Geo Feature: Archipelagic sea lane area (ARCSLN)

Primitives: Surface

Real World

Paper Chart Symbol

ECDIS Symbol

S-101 Attribute	S-57 Acronym	Allowable Encoding Value	Type	Multiplicity
Feature name			C	0,*
Display name			(S) BO	0,1
Language		ISO 639-3	(S) TE	0,1
Name	(OBJNAM) (NOBJNM)		(S) TE	1,1
Fixed date range			C	0,1
Date end	(DATEND)	ISO 8601: 2004	(S) TD	0,1
Date start	(DATSTA)	ISO 8601: 2004	(S) TD	0,1
Nationality	(NATION)		TE	1,1
Scale minimum	(SCAMIN)	See clause X.X	IN	0,1

INT 1 Reference: M 17

15.25.1 Archipelagic Sea Lane area (see S-4 – B-435.10)

Article 53 of the United Nations Convention on the Law of the Sea (UNCLOS) states that:

“an archipelagic State may designate sea lanes ..., suitable for the continuous and expeditious passage of foreign ships ... through ... its archipelagic waters and the adjacent Territorial Sea. ... All ships ... enjoy the right of archipelagic sea lanes passage in such sea lanes ... [which] include all normal passage routes used as routes for international navigation ... through archipelagic waters”. (Note: references to aircraft and air routes in UNCLOS have been omitted in these extracts from Article 53). (IHO S-4 B-435.10, C-51 Appendix 2 Part II).

Any archipelagic State which wishes to designate Archipelagic Sea Lanes (ASL) must propose them to IMO for adoption as ASL including all normal passage routes and navigational channels as required by UNCLOS. ASL are adopted by IMO in accordance with the relevant provisions of UNCLOS.

If it is required to encode an Archipelagic Sea Lane, it must be done using **Archipelagic Sea Lane Area** and/or **Archipelagic Sea Lane Axis** (see clause X.X) features, and possibly navigational aids features.

The unique character of Archipelagic Sea Lanes (ASLs) is specified by UNCLOS Article 53 and Part H, General Provision of IMO Ships Routeing. Further information is provided in the IHO publication C-51 (Manual on Technical Aspects of the United Nations Convention on the Law of the Sea).

The encoding of relationships between these features is defined in clause X.X.

Remarks:

- The feature **Archipelagic Sea Lane Area** encodes the area of an Archipelagic Sea Lane.
- In some cases only accurate information on the axes (**Archipelagic Sea Lane Axis**, see clause X.X) may be available and in such cases the extents of the ASL (**Archipelagic Sea Lane Area**) may not be able to be encoded.
- To encode an Archipelagic Sea Lane (ASL) system, the **Archipelagic Sea Lane Area**, **Archipelagic Sea Lane Axis** features, and any navigational aids features (if they are stated in the regulation defining the ASL), may be associated with the feature **Archipelagic Sea Lane** (see clause X.X) using the associations

ASL Aggregation (see clause X.X) and **Aids to Navigation** (see clause X.X). Where it is required to indicate the name of a complete ASL system, this should be done using the complex attribute **feature name** for the **Archipelagic Sea Lane** feature. Where it is required to encode textual information for the ASL, this should be done using an associated instance of the information class **Nautical Information** (see clause X.X), complex attribute **information**.

- Traffic within an ASL is not separated, except in any traffic separation schemes which may be designated in an ASL for the safe passage of ships.

Distinction: Administrative area; Archipelagic Sea Lane; Archipelagic Sea Lane axis; caution area; fairway; inshore traffic zone; recommended traffic lane part; restricted area navigational; restricted area regulatory; submarine transit lane; traffic separation scheme lane part; traffic separation zone; two-way route part.

Feature/Information associations

Type	Association Name	Association Ends					
		Class	Role	Mult	Class	Role	Mult
Aggr	ASL Aggregation	Archipelagic Sea Lane Area	Consists of	1,*	Archipelagic Sea Lane	Component of	0,1

15.26 Archipelagic Sea Lane Axis

IHO Definition: **ARCHIPELAGIC SEA LANE AXIS.** The reference line used to determine the maximum extents of an Archipelagic Sea Lane. It may not indicate the deepest water nor any recommended route or track.

S-101 Geo Feature: Archipelagic sea lane axis (ASLXIS)

Primitives: Curve

Real World

Paper Chart Symbol

ECDIS Symbol

S-101 Attribute	S-57 Acronym	Allowable Encoding Value	Type	Multiplicity
Feature name			C	0,*
Display name			(S) BO	0,1
Language		ISO 639-3	(S) TE	0,1
Name	(OBJNAM) (NOBJNM)		(S) TE	1,1
Fixed date range			C	0,1
Date end	(DATEND)	ISO 8601: 2004	(S) TD	0,1
Date start	(DATSTA)	ISO 8601: 2004	(S) TD	0,1
Nationality	(NATION)		TE	1,1
Scale minimum	(SCAMIN)	See clause X.X	IN	0,1

INT 1 Reference: M 17

15.26.1 Archipelagic Sea Lane Axis (see S-4 – B-435.10)

Article 53 of the United Nations Convention on the Law of the Sea (UNCLOS) states that:

“an archipelagic State may designate sea lanes ..., suitable for the continuous and expeditious passage of foreign ships ... through ... its archipelagic waters and the adjacent Territorial Sea. ... All ships ... enjoy the right of archipelagic sea lanes passage in such sea lanes ... [which] include all normal passage routes used as routes for international navigation ... through archipelagic waters”. (Note: references to aircraft and air routes in UNCLOS have been omitted in these extracts from Article 53). (IHO S-4 B-435.10, C-51 Appendix 2 Part II).

The axis line of an Archipelagic Sea lane (ASL) is encoded in ENCs only for the purpose of defining the sea lane. The axis line does not indicate any routes or recommended tracks as defined in IMO publication “*Ships’ Routeing*” Part A.

Remarks:

- To encode an Archipelagic Sea Lane (ASL) system, the **Archipelagic Sea Lane Area**, **Archipelagic Sea Lane Axis** features, and any navigational aids features (if they are stated in the regulation defining the ASL), may be associated with the feature **Archipelagic Sea Lane** (see clause X.X) using the associations **ASL Aggregation** (see clause X.X) and **Aids to Navigation** (see clause X.X). Where it is required to indicate the name of a complete ASL system, this should be done using the complex attribute **feature name** for the **Archipelagic Sea Lane** feature. Where it is required to encode textual information for the ASL, this should be done using an associated instance of the information class **Nautical Information** (see clause X.X), complex attribute **information**.
- All features comprising an ASL system must have the same value populated for the attribute SCAMIN (see clause X.X).

Distinction: Administrative area; Archipelagic Sea Lane; Archipelagic Sea Lane area; caution area; Deep Water route centreline; fairway; inshore traffic zone; navigation line; recommended route centreline; recommended track; recommended traffic lane part; restricted area navigational; restricted area regulatory;

submarine transit lane; traffic separation scheme lane part; traffic separation line; traffic separation zone; two-way route part.

Feature/Information associations							
Type	Association Name	Association Ends					
		Class	Role	Mult	Class	Role	Mult
Aggr	ASL Aggregation	Archipelagic Sea Lane Axis	Consists of	1,*	Archipelagic Sea Lane	Component of	0,1

15.27 Archipelagic Sea Lane

IHO Definition: **ARCHIPELAGIC SEA LANE.** Sea lanes designated by an archipelagic State for the passage of ships and aircraft. (IHO Dictionary – S-32).

S-101 Geo feature: Archipelagic Sea Lane

Primitives: None

Real World

Paper Chart Symbol

ECDIS Symbol

S-101 Attribute	S-57 Acronym	Allowable Encoding Value	Type	Multiplicity
Feature name			C	0,*
Display name			(S) BO	0,1
Language		ISO 639-3	(S) TE	0,1
Name	(OBJNAM) (NOBJNM)		(S) TE	1,1

INT 1 Reference: M 17

15.27.1 Archipelagic Sea Lanes (see S4 – B-435.10)

To define the complete Archipelagic Sea Lane (ASL) system, the features **Archipelagic Sea Lane Area**, **Archipelagic Sea Lane Axis** and any associated navigation aids must be collected to the feature **Archipelagic Sea Lane**.

Remarks:

- The name of the ASL must be populated using the complex attribute **feature name**.
- Where it is required to populate textual information for the ASL, this should be done using an associated instance of the information class **Nautical Information** (see clause X.X), complex attribute **information**, or if the information is considered essential for safe navigation, using a **Caution Area** feature (see clause X.X).

Distinction: Archipelagic Sea Lane area; Archipelagic Sea Lane axis; administrative area; caution area; fairway; fairway system; inshore traffic zone; restricted area navigational; restricted area regulatory; submarine transit lane; traffic separation scheme lane part; traffic separation zone; two-way route; two-way route part.

Feature/Information associations							
Type	Association Name	Association Ends					
		Class	Role	Mult	Class	Role	Mult
Aggr	ASL Aggregation	Archipelagic Sea Lane	Component of	0,1	Archipelagic Sea Lane	Consists of	1,*
Asso	Aids to Navigation Association	Archipelagic Sea Lane	Component of	0,1	Beacon Cardinal, Beacon Isolated Danger, Beacon Lateral, Beacon Safe Water, Beacon Special Purpose/General, Buoy Cardinal, Buoy Emergency Wreck Marking, Buoy Installation, Buoy Isolated Danger, Buoy Lateral, Buoy Safe	Consists of	1,*

					Water, Buoy Special Purpose/General, Daymark, Light Float, Light Vessel, Landmark, Pile		
Asso	Caution Area Association	Archipelagic Sea Lane	Component of	0,1	Caution Area	Consists of	1,*

15.28 Radio calling-in point

IHO Definition: **RADIO CALLING-IN POINT.** A designated position at which vessels are required to report to a Traffic Control Centre. Also called reporting point or radio reporting point. (IHO Dictionary – S-32).

S-101 Geo Feature: Radio calling-in point (RDOCAL)

Primitives: Point, Curve

Real World

Paper Chart Symbol

ECDIS Symbol

S-101 Attribute	S-57 Acronym	Allowable Encoding Value	Type	Multiplicity
Call sign	(CALSGN)		TE	0,1
Communication channel	(COMCHA)		TE	0,*
Feature name			C	0,*
Display name			(S) BO	0,1
Language		ISO 639-3	(S) TE	0,1
Name	(OBJNAM) (NOBJNM)		(S) TE	1,1
Fixed date range			C	0,1
Date end	(DATEND)	ISO 8601: 2004	(S) TD	0,1
Date start	(DATSTA)	ISO 8601: 2004	(S) TD	0,1
Orientation			C	0,2
Orientation uncertainty			(S) RE	0,1
Orientation value	(ORIENT)		(S) RE	1,1
Periodic date range			C	0,*
Date end	(PEREND)	ISO 8601: 2004	(S) TD	1,1
Date start	(PERSTA)	ISO 8601: 2004	(S) TD	1,1
Status	(STATUS)	1 : permanent 3 : recommended 4 : not in use 5 : periodic/intermittent 6 : reserved 7 : temporary 9 : mandatory	EN	0,*
Traffic flow	(TRAFIC)	1 : inbound 2 : outbound 3 : one-way 4 : two-way	EN	1,1
Scale minimum	(SCAMIN)	See clause X.X	IN	0,1

INT 1 Reference: M 40.1-2

15.28.1 Radio calling-in (reporting) points (see S-4 – B-488.1 and B-488.2)

Radio reporting points, also called radio calling-in points, have been established in certain busy waterways and port approaches to assist traffic control. On passing these points or crossing a defined line vessels are required to report on VHF to a Traffic Control Centre.

If it is required to encode a radio reporting point or line, it must be done using the feature **Radio Calling-in**

Point.Remarks:

- Each **Radio Calling-in Point** feature of type point must carry at least one orientation. If it is required to encode the reciprocal orientation, to indicate that a bearing and its opposite apply to a **Radio Calling-in Point** feature, it must be done using attribute **traffic flow = 4** (two-way). If the same position is used for another orientation (not opposite) of traffic flow, a second **orientation** complex attribute must be encoded.
- The complex attribute **feature name**, sub-attribute **name** is used to encode the name and/or alphanumeric designator of the **Radio Calling-in Point**.
- An associated instance of the information class **Nautical Information** (see clause X.X), complex attribute **information** is used to provide additional information, where required. For example, if the requirement to report by radio relates to certain classes of vessels only.
- **Radio Calling-in Point** features of type curve must be encoded such that resultant direction of the line (accounting for the direction of digitising and any subsequent reversal of the curve) is related such that the direction of traffic that is required to report is to the right. For curve features, it is not required to populate **orientation**.
- If it is required to encode the area of a Vessel Traffic Service (VTS) containing radio reporting points or requiring periodic position reporting, this should be done using the feature **Vessel Traffic Service Area** (see clause X.X).
- Each VHF-channel should be indicated, using the attribute **communication channel** (see clause X.X).

Distinction: Radio station; pilot boarding place; Vessel Traffic Service area.

15.29 Ferry route

IHO Definition: **FERRY ROUTE.** A route in a body of water where a ferry crosses from one shoreline to another. (Defence Geospatial Information Working Group; Feature Data Dictionary Register, 2010).

S-101 Geo Feature: Ferry route (FERYRT)

Primitives: Curve, Surface

Real World

Paper Chart Symbol

ECDIS Symbol

S-101 Attribute	S-57 Acronym	Allowable Encoding Value	Type	Multiplicity
Category of ferry	(CATFRY)	1 : "free-moving" ferry 2 : cable ferry 3 : ice ferry 5 : high speed ferry	EN	1,*
Feature name			C	0,*
Display name			(S) BO	0,1
Language		ISO 639-3	(S) TE	0,1
Name	(OBJNAM) (NOBJNM)		(S) TE	1,1
Fixed date range			C	0,1
Date end	(DATEND)	ISO 8601: 2004	(S) TD	0,1
Date start	(DATSTA)	ISO 8601: 2004	(S) TD	0,1
Periodic date range			C	0,*
Date end	(PEREND)	ISO 8601: 2004	(S) TD	1,1
Date start	(PERSTA)	ISO 8601: 2004	(S) TD	1,1
Status	(STATUS)	1 : permanent 2 : occasional 4 : not in use 5 : periodic/intermittent 6 : reserved 7 : temporary 8 : private 9 : mandatory 14 : public	EN	0,*
Scale minimum	(SCAMIN)	See clause X.X	IN	0,1

INT 1 Reference: M 50, 51

15.29.1 Ferries (see S-4 – B-438)

Ferry routes should be encoded on the largest maximum display scale ENC datasets:

- where they cross fairly narrow channels, in order that through traffic is warned of their existence;
- where the ferry tracks are short enough to be reasonably accurately represented; and
- on ENCs used for harbour navigation, as part of the general information about the area.

If it is required to encode a ferry route, it must be done using the feature **Ferry Route**.

Remarks:

- Long distance ferries which have routes varying with weather, tide and traffic should not generally be encoded, although the terminals should be shown on appropriate maximum display scale ENC datasets, using the feature **Harbour Facility** (see clause X.X), with attribute **category of harbour facility** = 1 (RoRo-

terminal) or 3 (ferry terminal).

Distinction:

15.30 Radar line

IHO Definition: **RADAR LINE.** A track along which ships may be guided by coastal radar stations in the event of bad visibility. Also known as a radar guided track. (IHO Dictionary – S-32).

S-101 Geo Feature: Radar line (RADLNE)

Primitives: Curve

Real World

Paper Chart Symbol

ECDIS Symbol

S-101 Attribute	S-57 Acronym	Allowable Encoding Value	Type	Multiplicity
Feature name			C	0,*
Display name			(S) BO	0,1
Language		ISO 639-3	(S) TE	0,1
Name	(OBJNAM) (NOBJNM)		(S) TE	1,1
Orientation			C	1,1
Orientation uncertainty			(S) RE	0,1
Orientation value	(ORIENT)		(S) RE	1,1
Status	(STATUS)	1 : permanent 2 : occasional 3 : recommended 4 : not in use 7 : temporary	EN	0,*
Scale minimum	(SCAMIN)	See clause X.X	IN	0,1

INT 1 Reference: M 32.1-2

15.30.1 Radar reference lines (see S-4 – B-487.2)

Radar reference lines are mid-channel lines corresponding to lines incorporated in Vessel Traffic Services (VTS) radar displays. A line is used as a positional reference so that the VTS authorities may easily provide a vessel with its position, relative to the line, when visibility is poor. These must be charted on appropriate maximum display scale ENC data.

If it is required to encode a radar reference line, it must be done using the feature **Radar Line**.

Remarks:

- The value of orientation encoded on the complex attribute **orientation** should be the value of the bearing from seaward. If it is not possible to define a seaward direction, the value that is less than 180° should be used.
- If it is required to encode the area of a VTS containing radar lines, this should be done using the feature **Vessel Traffic Service Area** (see clause X.X).

Distinction: Radar range; recommended track; Vessel Traffic Service area.

15.31 Radar range

IHO Definition: RADAR RANGE. Indicates the coverage of a sea area by a radar surveillance station. Inside this area a vessel may request shore-based radar assistance, particularly in poor visibility. (Adapted from Defence Geospatial Information Working Group; Feature Data Dictionary Register, 2010).

S-101 Geo Feature: Radar range (RADRNG)

Primitives: Surface

Real World

Paper Chart Symbol

ECDIS Symbol

S-101 Attribute	S-57 Acronym	Allowable Encoding Value	Type	Multiplicity
Communication channel	(COMCHA)		TE	0,*
Feature name			C	0,*
Display name			(S) BO	0,1
Language		ISO 639-3	(S) TE	0,1
Name	(OBJNAM) (NOBJNM)		(S) TE	1,1
Fixed date range			C	0,1
Date end	(DATEND)	ISO 8601: 2004	(S) TD	0,1
Date start	(DATSTA)	ISO 8601: 2004	(S) TD	0,1
Status	(STATUS)	1 : permanent 2 : occasional 4 : not in use 7 : temporary	EN	0,*
Scale minimum	(SCAMIN)	See clause X.X	IN	0,1

INT 1 Reference: M 31

15.31.1 Radar ranges (see S-4 – B-487.1)

Many large ports have a radar surveillance system covering their approaches to provide guidance for vessels, particularly in poor visibility. The maximum range of the system forms an arc or series of overlapping arcs.

If it is required to encode a radar range, it must be done using the feature **Radar Range**.

Remarks:

- Each VHF-channel should be indicated, using the attribute **communication channel** (see clause X.X).

Distinction: Radar line; Vessel Traffic Service area.

15.32 Radar station

IHO Definition: **RADAR STATION.** A station with a transmitter emitting pulses of ultra-high frequency radio waves which are reflected by solid objects and are detected upon their return to the sending station. (International Maritime Dictionary, 2nd Edition).

S-101 Geo Feature: Radar station (RADSTA)

Primitives: Point

Real World

Paper Chart Symbol

ECDIS Symbol

S-101 Attribute	S-57 Acronym	Allowable Encoding Value	Type	Multiplicity
Call sign	(CALSGN)		TE	0,1
Category of radar station	(CATRAS)	1 : radar surveillance station 2 : coast radar station	EN	0,*
Communication channel	(COMCHA)		TE	0,*
Feature name			C	0,*
Display name			(S) BO	0,1
Language		ISO 639-3	(S) TE	0,1
Name	(OBJNAM) (NOBJNM)		(S) TE	1,1
Height	(HEIGHT)		RE	0,1
Periodic date range			C	0,*
Date end	(PEREND)	ISO 8601: 2004	(S) TD	1,1
Date start	(PERSTA)	ISO 8601: 2004	(S) TD	1,1
Status	(STATUS)	1 : permanent 2 : occasional 4 : not in use 7 : temporary 8 : private	EN	0,*
Value of maximum range	(VALMXR)		RE	0,1
Scale minimum	(SCAMIN)	See clause X.X	IN	0,1

INT 1 Reference: M 30; S 1

15.32.1 Radar station (see S-4 – B-485.1 and B-487.3)

If it is required to encode a radar station, it must be done using the feature **Radar Station**.

Remarks:

- Coast radar stations are shore-based stations which the mariner can contact by radio to obtain a position. These stations are being increasingly replaced by other position-fixing methods.
- The **Radar Station** must only be used to encode the technical equipment itself, independent of the building or structure in which it is installed. If it is required to encode the building or structure (for example mast, tower, radar dome) it must be done using an appropriate feature (for example **Building, Landmark**). There is no requirement to establish a Structure/Equipment association between the **Radar Station** feature and the structure in which it is installed.
- The attribute **height** is used to encode the height of the emitting part of the radar, where known.
- Each VHF-channel should be indicated, using the attribute **communication channel** (see clause X.X).

Distinction: Radar line; radar range; radar transponder beacon.

16 Geo Features – Areas, limits

16.1 International boundaries and national limits (see S-4 – B-440)

The United Nations Convention on the Law of the Sea, 1982 came into force on 16 November 1994. UNCLOS contains navigational provisions as well as provisions for determining the limits of various maritime zones. These provisions are binding to all states that have ratified the Convention. For technical aspects of UNCLOS, see IHO publication C-51.

IHO Member States should show, on selected series of their ENC, their own baseline and maritime limits in accordance with UNCLOS (former IHO Technical Resolution B2.35).

The mariner may be interested in the exact location of international maritime boundaries for two principal reasons:

- When crossing a boundary they could be subject to different laws and regulations which may affect their navigation, for example buoyage systems, pilotage regulations, fishing rights, reporting procedures, pollution regulations.
- Where a boundary passes through groups of offshore islands they may wish to know upon which side of the boundary a particular island falls.

16.2 Maritime jurisdiction areas

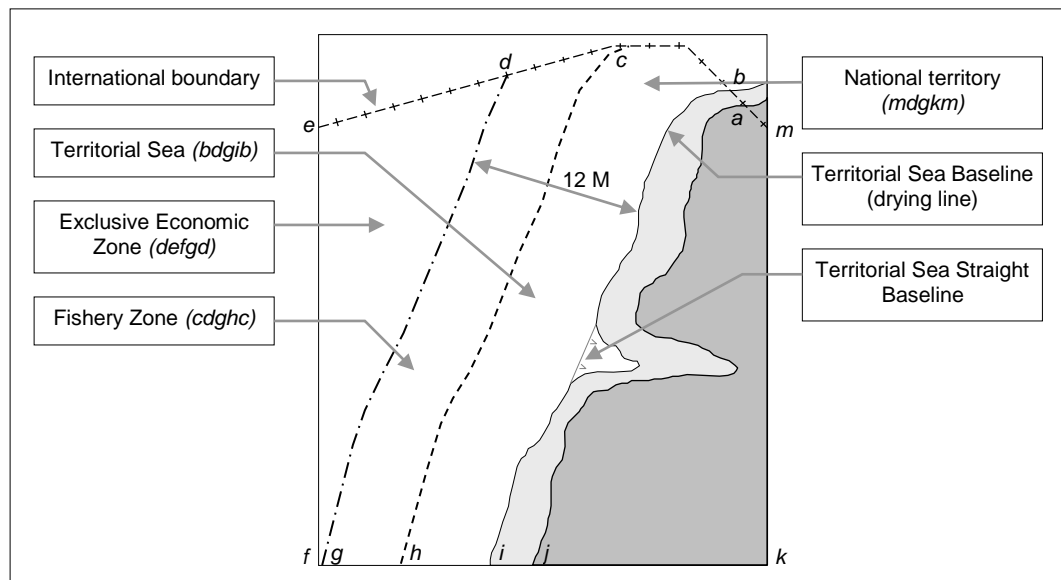

The clauses in Section 16 below provide guidance for the encoding of maritime jurisdiction areas. Occasionally, these “areas” may actually be defined as linear due to international treaties, or the areas may not be fully defined and it may therefore be necessary to encode the boundary as a linear feature. Clause X.X defining features permitted for use in ENC and their geometric primitives does not allow many of the feature classes relating to maritime jurisdiction areas to be encoded as type curve.

If it is required to encode a linear maritime jurisdiction feature, it must be done using the corresponding feature class as outlined in Section 16 below. If the “curve” primitive is not permitted for the related feature class, the linear maritime jurisdiction feature must be encoded as a “very narrow” feature of type surface, and by masking all the edges of the area that are not relevant (that is, are not along the reference line – see clause X.X). **Note that this method must not be used where an area can be defined.**

The “very narrow surface” should be a surface having an edge corresponding to the reference line and be about 0.2mm in width at the maximum display scale of the ENC data. Caution notes for such areas must be encoded using an associated instance of the information class **Nautical Information** (see clause X.X), complex attribute **information**.

16.2.1 Maritime jurisdiction areas in dispute

In accordance with Article 55 of the United Nations Convention on the Law of the Sea (UNCLOS – 10 December 1982), a Coastal State's Territorial Sea Area and Exclusive Economic Zone must not overlap. Occasionally, small areas at the boundary of two or more Coastal States may be in dispute regarding the establishment of maritime jurisdiction, which may result in a small section of Territorial Sea overlapping an EEZ in the disputed area.

Where issues of maritime jurisdiction between two or more Coastal States are in dispute, the proposed Territorial Sea (**Territorial Sea Area**) of one Coastal State may overlap the proposed EEZ (**Exclusive Economic Zone**) of another Coastal State. In this case, the disputed area should be encoded with separate **Territorial Sea Area** and **Exclusive Economic Zone** features, with Boolean attribute **in dispute** set to *True* and the mandatory attribute **nationality** populated with the country codes (conforming to ISO 3166) of the disputing states (see clause X.X).

16.3 Anchorage area

IHO Definition: ANCHORAGE AREA. An area in which vessels or seaplanes anchor or may anchor. (Adapted from IHO Dictionary – S-32).				
S-101 Geo Feature: Anchorage area (ACHARE)				
Primitives: Point, Surface				
<i>Real World</i>		<i>Paper Chart Symbol</i>		<i>ECDIS Symbol</i>
S-101 Attribute	S-57 Acronym	Allowable Encoding Value	Type	Multiplicity
Category of anchorage	(CATACH)	1 : unrestricted anchorage 2 : deep water anchorage 3 : tanker anchorage 4 : explosives anchorage 5 : quarantine anchorage 6 : seaplane anchorage 7 : small craft anchorage 8 : small craft mooring area 9 : anchorage for periods up to 24 Hours 10 : anchorage for a limited period of time 14 : waiting anchorage 15 : reported anchorage	EN	0,*
Feature name			C	0,*
Display name			(S) BO	0,1
Language		ISO 639-3	(S) TE	0,1
Name	(OBJNAM) (NOBJNM)		(S) TE	1,1
Fixed date range			C	0,1
Date end	(DATEND)	ISO 8601: 2004	(S) TD	0,1
Date start	(DATSTA)	ISO 8601: 2004	(S) TD	0,1
Periodic date range			C	0,*
Date end	(PEREND)	ISO 8601: 2004	(S) TD	1,1
Date start	(PERSTA)	ISO 8601: 2004	(S) TD	1,1
Restriction	(RESTRN)	2 : anchoring restricted 3 : fishing prohibited 4 : fishing restricted 5 : trawling prohibited 6 : trawling restricted 8 : entry restricted 9 : dredging prohibited 10 : dredging restricted 11 : diving prohibited 12 : diving restricted 13 : no wake 15 : construction prohibited 16 : discharging prohibited 17 : discharging restricted 18 : industrial or mineral exploration/development	EN	0,*

		prohibited 19 : industrial or mineral exploration/development restricted 20 : drilling prohibited 21 : drilling restricted 23 : cargo transshipment (lightening) prohibited 24 : dragging prohibited 27 : speed restricted 39 : swimming prohibited		
Status	(STATUS)	1 : permanent 2 : occasional 3 : recommended 5 : periodic/intermittent 6 : reserved 7 : temporary 8 : private 9 : mandatory 14 : public	EN	0,*
Scale minimum	(SCAMIN)	See clause X.X	IN	0,1

INT 1 Reference: N 10, 12.1-9, 14; Q 44

16.3.1 Anchorages (see S-4 – B-431.1; B-431.3 and B-431.7)

Where the limits of anchorages are defined by a regulatory authority (for example harbour authority) they must be shown on the largest maximum display scale ENC data. They may also be shown on other maximum display scale ENC datasets where useful, for example, for planning purposes.

If it is required to encode an anchorage area, including anchorages for seaplanes, it must be done using the feature **Anchorage Area**.

Remarks:

- The complex attribute **feature name**, sub-attribute **name** is used to encode the name and/or number of the **Anchorage Area**.
- An associated instance of the information class **Nautical Information** (see clause X.X), complex attribute **information** may be used to provide additional information about the category of anchorage, where required.
- Individual recommended anchorages without defined limits should be encoded as **Anchorage Area** features of type point, with attributes **category of anchorage** = 1 (unrestricted anchorage) and **status** = 3 (recommended).
- Areas with numerous small craft moorings may be encoded as **Anchorage Area** features of type surface, with **category of anchorage** = 8 (small craft mooring area). For the encoding of mooring buoys, see clause X.X.
- If it is required to encode an anchorage which may be used for a period of not more than 24 hours, it must be done using **category of anchorage** = 9 (anchorage for periods up to 24 hours).
- If it is required to encode an anchorage with a specific, limited time period, it must be done using **category of anchorage** = 10 (anchorage for limited period of time). The specific limit of time should be encoded using an associated instance of the information class **Nautical Information** (see clause X.X), complex attribute **information**, sub-attribute **text** (for example *Anchorage limited to 12 hours*).
- Areas where anchoring is prohibited must be encoded, where required, as **Restricted Area Navigational** (see clause X.X) with attribute **restriction** = 1 (anchoring prohibited).

Distinction: Anchor berth; mooring/warping facility.

16.4 Anchor berth

IHO Definition: ANCHOR BERTH. A designated area of water where a single vessel, seaplane, etc... may anchor. (S-57 Edition 3.1, Appendix A – Chapter 1, Page 1.6, November 2000).				
S-101 Geo Feature: Anchor berth (ACHBRT)				
Primitives: Point, Surface				
<i>Real World</i>		<i>Paper Chart Symbol</i>		<i>ECDIS Symbol</i>
S-101 Attribute	S-57 Acronym	Allowable Encoding Value	Type	Multiplicity
Category of anchorage	(CATACH)	1 : unrestricted anchorage 2 : deep water anchorage 3 : tanker anchorage 4 : explosives anchorage 5 : quarantine anchorage 6 : seaplane anchorage 7 : small craft anchorage 8 : small craft mooring area 9 : anchorage for periods up to 24 Hours 10 : anchorage for a limited period of time 14 : waiting anchorage	EN	0,*
Feature name			C	0,*
Display name			(S) BO	0,1
Language		ISO 639-3	(S) TE	0,1
Name	(OBJNAM) (NOBJNM)		(S) TE	1,1
Fixed date range			C	0,1
Date end	(DATEND)	ISO 8601: 2004	(S) TD	0,1
Date start	(DATSTA)	ISO 8601: 2004	(S) TD	0,1
Periodic date range			C	0,*
Date end	(PEREND)	ISO 8601: 2004	(S) TD	1,1
Date start	(PERSTA)	ISO 8601: 2004	(S) TD	1,1
Radius	(RADIUS)		RE	0,1
Status	(STATUS)	1 : permanent 2 : occasional 3 : recommended 4 : not in use 5 : periodic/intermittent 6 : reserved 7 : temporary 8 : private 9 : mandatory 14 : public	EN	0,*
Scale minimum	(SCAMIN)	See clause X.X	IN	0,1
INT 1 Reference: N 11.1, 11.2				

16.4.1 Anchor berths (see S-4 – B-431.2)

Where the positions or limits of anchorages, including anchor berths, are defined by a regulatory authority (for example harbour authority) they must be shown on the largest maximum display scale ENC data. They may also be shown on other maximum display scale data where useful, for example, for planning purposes.

If it is required to encode an anchor berth, it must be done using the feature **Anchor Berth**.

Remarks:

- The complex attribute **feature name**, sub-attribute **name** is used to encode the name and/or number of the **Anchor Berth**. If a group of anchor berths is known by a single common name, the name should be encoded using a **Sea Area/Named Water Area** feature (see clause X.X) covering the area of the anchor berths.
- An associated instance of the information class **Nautical Information** (see clause X.X), complex attribute **information** may be used to provide additional information about the category of anchorage, where required.
- If an anchor berth is defined by a centre point and a swinging circle, it should be of type point, with the radius of the swinging circle encoded using the attribute **radius**.

Distinction: Anchorage area; berth; mooring/warping facility.

16.5 Seaplane landing area

IHO Definition: SEAPLANE LANDING AREA. A designated portion of water for the landing and take-off of seaplanes. (S-57 Edition 3.1, Appendix A – Chapter 1, Page 1.152, November 2000).				
S-101 Geo Feature: Seaplane landing area (SPLARE)				
Primitives: Point, Surface				
<i>Real World</i>		<i>Paper Chart Symbol</i>		<i>ECDIS Symbol</i>
S-101 Attribute	S-57 Acronym	Allowable Encoding Value	Type	Multiplicity
Feature name			C	0,*
Display name			(S) BO	0,1
Language		ISO 639-3	(S) TE	0,1
Name	(OBJNAM) (NOBJNM)		(S) TE	1,1
Periodic date range			C	0,*
Date end	(PEREND)	ISO 8601: 2004	(S) TD	1,1
Date start	(PERSTA)	ISO 8601: 2004	(S) TD	1,1
Restriction	(RESTRN)	1 : anchoring prohibited 2 : anchoring restricted 3 : fishing prohibited 4 : fishing restricted 5 : trawling prohibited 6 : trawling restricted 7 : entry prohibited 8 : entry restricted 9 : dredging prohibited 10 : dredging restricted 11 : diving prohibited 12 : diving restricted 13 : no wake 15 : construction prohibited 16 : discharging prohibited 17 : discharging restricted 18 : industrial or mineral exploration/development prohibited 19 : industrial or mineral exploration/development restricted 20 : drilling prohibited 21 : drilling restricted 22 : removal of historical artefacts prohibited 23 : cargo transhipment (lightening) prohibited 24 : dragging prohibited 25 : stopping prohibited 27 : speed restricted 39 : swimming prohibited	EN	0,*
Status	(STATUS)	1 : permanent 2 : occasional 3 : recommended	EN	0,*

		4 : not in use 5 : periodic/intermittent 6 : reserved 7 : temporary 8 : private 9 : mandatory 14 : public		
Scale minimum	(SCAMIN)	See clause X.X	IN	0,1
<p><u>INT 1 Reference:</u> N 13</p> <p>16.5.1 Seaplane landing areas (see S-4 – B-449.6)</p> <p>If it is required to encode a seaplane landing area, it must be done using the feature Seaplane Landing Area.</p> <p><u>Remarks:</u></p> <ul style="list-style-type: none"> • If it is required to encode an area where seaplanes draw water for firefighting activities, this must be done using Seaplane Landing Area. • If it is required to encode an anchorage for seaplanes, it must be done using an Anchorage Area feature (see clause X.X), with attribute category of anchorage = 6 (seaplane anchorage). <p><u>Distinction:</u> Airport area; runway.</p>				

16.6 Dumping ground

IHO Definition: DUMPING GROUND. A sea area where dredged material or other potentially more harmful material, for example explosives, chemical waste, is deliberately deposited. (S-57 Edition 3.1, Appendix A – Chapter 1, Page 1.59, November 2000).				
S-101 Geo Feature: Dumping ground (DMPGRD)				
Primitives: Point, Surface				
<i>Real World</i>		<i>Paper Chart Symbol</i>		<i>ECDIS Symbol</i>
S-101 Attribute	S-57 Acronym	Allowable Encoding Value	Type	Multiplicity
Category of dumping ground	(CATDPG)	2 : chemical waste dumping ground 3 : nuclear waste dumping ground 4 : explosives dumping ground 5 : spoil ground 6 : vessel dumping ground	EN	0,*
Date disused			TD	0,1
Feature name			C	0,*
Display name			(S) BO	0,1
Language		ISO 639-3	(S) TE	0,1
Name	(OBJNAM) (NOBJNM)		(S) TE	1,1
Restriction	(RESTRN)	1 : anchoring prohibited 2 : anchoring restricted 3 : fishing prohibited 4 : fishing restricted 5 : trawling prohibited 6 : trawling restricted 7 : entry prohibited 8 : entry restricted 9 : dredging prohibited 10 : dredging restricted 11 : diving prohibited 12 : diving restricted 13 : no wake 17 : discharging restricted 18 : industrial or mineral exploration/development prohibited 19 : industrial or mineral exploration/development restricted 20 : drilling prohibited 21 : drilling restricted 22 : removal of historical artefacts prohibited 23 : cargo transhipment (lightening) prohibited 24 : dragging prohibited 25 : stopping prohibited 27 : speed restricted	EN	0,*

Status	(STATUS)	1 : permanent 2 : occasional 4 : not in use 6 : reserved 7 : temporary	EN	0,*
Scale minimum	(SCAMIN)	See clause X.X	IN	0,1

INT 1 Reference: N 23, 24, 62.1, 62.2

16.6.1 Dumping grounds (see S-4 – B-442; B-446 and B-446.1)

Materials deliberately dumped at sea in specified areas (other than those associated with reclamation works) may be classified, according to their significance to the mariner, as follows:

- Materials which are generally dispersed before reaching the seabed, for example sewage sludge, are of little navigational significance and no charting action is usually required.
- Spoil from dredging operations or other works which might reduce charted depths significantly in the designated spoil ground.
- Harmful materials, including explosives and chemicals, which are likely to remain concentrated on the seabed.

Dumping of harmful materials is unlikely to affect depths substantially and such dumping grounds are encoded primarily as a warning against anchoring, trawling or other submarine operations.

If it is required to encode a dumping ground, it must be done using the feature **Dumping Ground**.

Remarks:

- A **Dumping Ground** feature of type surface must be covered by features from Skin of the Earth as appropriate (**Depth Area** or **Unsurveyed Area**).
- Disused dumping grounds for harmful materials are considered dangerous for an indefinite period and must therefore be encoded on the largest maximum display scale ENC datasets, with attribute **status** = 4 (not in use). The date when the area ceased to be used may be populated using the attribute **date disused**, if known.
- Within a spoil ground; if the depths within the area are liable to be very much less than charted after the discharge of spoil, they may be treated as unsurveyed areas (see clause X.X), in which case soundings and depth contours may be omitted from the area,

16.6.2 Spoil grounds, dredging areas (see S-4 – B-446)

Spoil grounds are areas set aside, clear of shipping channels and in deep water where possible, for the disposal of material (spoil) generally obtained by dredging. Their significance to the mariner is that very large quantities of material may be dumped, decreasing the depth of water available.

Extraction (or dredging) areas are those areas where a concentration of dredging vessels may be encountered, taking up sand or shingle to be brought ashore (for example for construction purposes). Their significance is primarily as a collision hazard, although they also indicate the likelihood of finding a greater depth of water than charted. Channels dredged to provide an adequate depth of water for navigation are “dredged areas”, not to be confused with “dredging areas”.

If it is required to encode a spoil ground, it must be done using a **Dumping Ground** feature, with attribute **category of dumping ground** = 5 (spoil ground).

If it is required to encode a dredging area, it must be done using a **Restricted Area Navigational** feature (see clause X.X) or **Restricted Area Regulatory** feature (see clause X.X), with attribute **category of restricted area** = 21 (dredging area). An area in which seabed material (for example sand, shingle) is being extracted for purposes such as construction must be encoded, where required, using the feature **Offshore Production Area** (see clause X.X), with attribute **category of production area** = 13 (seabed material extraction area).

Distinction: Dredged area.

16.7 Military practice area

IHO Definition: MILITARY PRACTICE AREA. An area within which naval, military or aerial exercises are carried out. Also called an exercise area. (Adapted from IHO Dictionary – S-32).				
S-101 Geo Feature: Military practice area (MIPARE)				
Primitives: Point, Surface				
<i>Real World</i>	<i>Paper Chart Symbol</i>	<i>ECDIS Symbol</i>		
S-101 Attribute	S-57 Acronym	Allowable Encoding Value	Type	Multiplicity
Category of military practice area	(CATMPA)	2 : torpedo exercise area 3 : submarine exercise area 4 : firing danger area 5 : mine-laying practice area 6 : small arms firing range	EN	0,*
Feature name			C	0,*
Display name			(S) BO	0,1
Language		ISO 639-3	(S) TE	0,1
Name	(OBJNAM) (NOBJNM)		(S) TE	1,1
Fixed date range			C	0,1
Date end	(DATEND)	ISO 8601: 2004	(S) TD	0,1
Date start	(DATSTA)	ISO 8601: 2004	(S) TD	0,1
Nationality	(NATION)		TE	0,1
Periodic date range			C	0,*
Date end	(PEREND)	ISO 8601: 2004	(S) TD	1,1
Date start	(PERSTA)	ISO 8601: 2004	(S) TD	1,1
Restriction	(RESTRN)	1 : anchoring prohibited 2 : anchoring restricted 3 : fishing prohibited 4 : fishing restricted 5 : trawling prohibited 6 : trawling restricted 7 : entry prohibited 8 : entry restricted 9 : dredging prohibited 10 : dredging restricted 11 : diving prohibited 12 : diving restricted 13 : no wake 15 : construction prohibited 16 : discharging prohibited 17 : discharging restricted 18 : industrial or mineral exploration/development prohibited 19 : industrial or mineral exploration/development restricted 20 : drilling prohibited	EN	0,*

		21 : drilling restricted 22 : removal of historical artefacts prohibited 23 : cargo transhipment (lightening) prohibited 24 : dragging prohibited 25 : stopping prohibited 26 : landing prohibited 27 : speed restricted 39 : swimming prohibited		
Status	(STATUS)	1 : permanent 2 : occasional 5 : periodic/intermittent 6 : reserved 7 : temporary 16 : watched 17 : un-watched	EN	0,*
Scale minimum	(SCAMIN)	See clause X.X	IN	0,1

INT 1 Reference: N 30-33

16.7.1 Military practice areas (see S-4 – B-441.1-6)

Military practice (or exercise) areas at sea are of various types and may be classified as follows with regard to their significance for the mariner:

- Firing danger areas, sometimes called firing practice areas; that is, permanent or temporary ranges, including bombing, torpedo and missile ranges.
- Mine-laying practice (and counter-measures) areas.
- Submarine exercise areas.
- Other exercise areas.

Some degree of restriction on navigation and other rights may be implied by the encoding of military practice areas. There may be varying interpretations of the validity of the restrictions and possible infringement of the rights of innocent passage through territorial waters and elsewhere. Where it is thought desirable to depict such areas, even though clear range procedure may be observed, or the areas appear to be a derogation of the freedom of the seas, mariners should be informed (not necessarily on ENCs) that publication of the details of a law or regulation is solely for the safety and convenience of shipping and implies no recognition of the international validity of the law or regulation. By this means infringements are not condoned but the mariner receives a warning which may be necessary for their safety.

If it is required to encode a military practice area, it must be done using the feature **Military Practice Area**.

Remarks:

- Submarine exercise areas should generally not be encoded where submarines exercise over wide areas which it would not be practicable to depict, and over which cautions (to keep a good look out for them) are unlikely to be effective. They may, however, be encoded where they occur in or near major shipping lanes or port approaches.
- Firing danger areas at sea are frequently marked by IALA special buoys sometimes laid around the perimeter of the area and/or by specially erected lights, beacons and targets. If required, all such features which could assist the navigator in identifying their position, or could be a hazard, must be encoded in the normal way,
- The existence of mine laying (and counter-measures/clearance) practice areas implies the possibility of unexploded mines or depth charges on the sea floor, and also the presence of harmless practice mines.

Distinction: Caution area; restricted area navigational; restricted area regulatory; submarine transit lane.

16.8 Administration area

IHO Definition: **ADMINISTRATION AREA.** A defined area within which a jurisdiction applies. It may or may not be named.

S-101 Geo Feature: Administration area (ADMARE)

Primitives: Surface

Real World

Paper Chart Symbol

ECDIS Symbol

S-101 Attribute	S-57 Acronym	Allowable Encoding Value	Type	Multiplicity
In dispute			BO	0,1
Jurisdiction	(JRSDTN)	1 : international 2 : national 3 : national sub-division	EN	1,1
Feature name			C	0,*
Display name			(S) BO	0,1
Language		ISO 639-3	(S) TE	0,1
Name	(OBJNAM) (NOBJNM)		(S) TE	1,1
Nationality	(NATION)		TE	0,*
Scale minimum	(SCAMIN)	See clause X.X	IN	0,1

INT 1 Reference: N 40, 41

16.8.1 International and national territories (see S-4 – B-440.1 and B-440.3)

International maritime boundaries are those which have been established by agreement between adjacent or opposite States. Boundaries are sometimes negotiated on the basis of the equidistance or “median” line principle. For various reasons, however, agreed boundaries even when negotiated on this principle are seldom true median lines.

Navigationally, international boundaries may vary in their significance over different parts of their lengths. Inshore, they may represent the delimitation of Territorial Seas of two states or “internal waters”, (for example within bay closing lines or straight baseline systems). Offshore, they may represent Exclusive Economic Zone and/or Continental Shelf boundaries.

If it is required to encode a named international or national territory, it must be done using the feature **Administration Area**.

Remarks:

- International land boundaries should be encoded, at least in the vicinity of coasts.

Distinction: Contiguous Zone; Continental Shelf area; Exclusive Economic Zone; fishery zone; land region; Territorial Sea area; vessel traffic service area.

16.9 Cargo transshipment area

IHO Definition: **CARGO TRANSHIPMENT AREA.** An area designated for the transfer of cargo from one vessel to another, usually to reduce the draught of the larger vessel. Also called lightening or cargo transfer area. (Adapted from IHO Dictionary – S-32).

S-101 Geo Feature: Cargo transshipment area (CTSARE)

Primitives: Point, Surface

Real World

Paper Chart Symbol

ECDIS Symbol

S-101 Attribute	S-57 Acronym	Allowable Encoding Value	Type	Multiplicity
Feature name			C	0,*
Display name			(S) BO	0,1
Language		ISO 639-3	(S) TE	0,1
Name	(OBJNAM) (NOBJNM)		(S) TE	1,1
Fixed date range			C	0,1
Date end	(DATEND)	ISO 8601: 2004	(S) TD	0,1
Date start	(DATSTA)	ISO 8601: 2004	(S) TD	0,1
Periodic date range			C	0,*
Date end	(PEREND)	ISO 8601: 2004	(S) TD	1,1
Date start	(PERSTA)	ISO 8601: 2004	(S) TD	1,1
Restriction	(RESTRN)	2 : anchoring restricted 3 : fishing prohibited 4 : fishing restricted 5 : trawling prohibited 6 : trawling restricted 8 : entry restricted 9 : dredging prohibited 10 : dredging restricted 11 : diving prohibited 12 : diving restricted 13 : no wake 15 : construction prohibited 16 : discharging prohibited 17 : discharging restricted 18 : industrial or mineral exploration/development prohibited 19 : industrial or mineral exploration/development restricted 20 : drilling prohibited 21 : drilling restricted 22 : removal of historical artefacts prohibited 24 : dragging prohibited 27 : speed restricted 39 : swimming prohibited	EN	0,*
Status	(STATUS)	1 : permanent 2 : occasional	EN	0,*

		3 : recommended 5 : periodic/intermittent 6 : reserved 7 : temporary 9 : mandatory		
Scale minimum	(SCAMIN)	See clause X.X	IN	0,1
<p><u>INT 1 Reference:</u> N 64</p> <p>16.9.1 Cargo transshipment areas (see S-4 – B-449.4)</p> <p>Areas generally outside port limits may be specifically designated as suitable for the transshipment of oil or other materials from large ships to smaller vessels. The areas selected are relatively sheltered locations and lie off main shipping routes. As the purpose of transshipment is usually to reduce the draught of the larger vessel to allow it to proceed to port, the operation is often known as “lightening” and the areas may be known as “lightening areas” or “cargo transfer areas”.</p> <p>If it is required to encode a cargo transshipment area, it must be done using the feature Cargo Transshipment Area.</p> <p><u>Remarks:</u></p> <ul style="list-style-type: none"> The encoding of cargo transshipment areas should be adequate to warn other vessels of the likelihood of encountering ships restricted in their ability to manoeuvre. Regulations governing the use of such areas should be encoded using the attribute restriction or an associated instance of the information class Nautical Information (see clause X.X), complex attribute information. <p><u>Distinction:</u> Dock area; harbour area (administrative); harbour facility.</p>				

16.10 Caution area

IHO Definition: **CAUTION AREA.** Generally, an area where the mariner has to be made aware of circumstances influencing the safety of navigation. (S-57 Edition 3.1, Appendix A – Chapter 1, Page 1.33, November 2000).

S-101 Geo Feature: Caution area (CTNARE)

Primitives: Point, Surface

Real World

Paper Chart Symbol

ECDIS Symbol

S-101 Attribute	S-57 Acronym	Allowable Encoding Value	Type	Multiplicity
Condition	(CONDTN)	1 : under construction 3 : under reclamation 5 : planned construction	EN	0,1
Fixed date range			C	0,1
Date end	(DATEND)	ISO 8601: 2004	(S) TD	0,1
Date start	(DATSTA)	ISO 8601: 2004	(S) TD	0,1
Periodic date range			C	0,*
Date end	(PEREND)	ISO 8601: 2004	(S) TD	1,1
Date start	(PERSTA)	ISO 8601: 2004	(S) TD	1,1
Reported date	(SORDAT)	ISO 8601: 2004	TD	0,1
Status	(STATUS)	5 : periodic/intermittent 7 : temporary	EN	0,1
Scale minimum	(SCAMIN)	See clause X.X	IN	0,1

INT 1 Reference:

16.10.1 Caution areas (see S-4 – B-242)

If it is required to identify an area in which the mariner must be aware of circumstances influencing the safety of navigation (for example an area of continually changing depths), and which cannot be encoded using other feature types, it must be done using the feature **Caution Area**. This feature may be required to identify a danger, a risk, a rule or advice that is not directly related to a particular feature.

Remarks:

- To encode the relevant cautionary information, an instance of the information class **Nautical Information** (see clause X.X) must be associated to the **Caution Area**.
- If the information applies to a specific area the **Caution Area** feature should cover only that area.
- If the information to be encoded is spatially linear, this should be encoded using a “very narrow” **Caution Area** feature of type area (approximately 0-2mm wide at the maximum display scale of the ENC data) similar to the method for encoding linear maritime jurisdiction areas (see clause X.X).
- Information which may be of use to the mariner, but is not significant to safe navigation and cannot be encoded using other feature types, should be encoded using an **Information Area** feature (see clause X.X), and using an associated instance of the information class **Nautical Information** (see clause X.X), complex attribute **information** (see clause X.X). This encoding is intended to reduce the number of alarms or indications generated in the ECDIS due to the overuse of **Caution Area** features.
- Notes should be kept to a minimum and be as concise as is compatible with accuracy and intelligibility. Hydrographic terminology (jargon) should be avoided, giving preference to easily understood words, for example “depths” rather than “bathymetry”.
- In order to ensure correct ECDIS display, **Caution Area** features of type surface should not share the geometry of features such as **Depth Contour** and other features with higher ECDIS display priorities, as the

Caution Area will appear to be “open ended”, which may confuse the mariner. Where this occurs, the edge of the **Caution Area** should be extended outward to clear the “shared” edge, sufficient to avoid “duplicate geometry” validation errors (that is, about 0.2mm at the maximum display scale for the ENC data).

Distinction: Collision regulations limit; depth discontinuity; information area; obstruction; underwater/awash rock; unsurveyed area; wreck.

Feature/Information associations							
Type	Association Name	Association Ends					
		Class	Role	Mult	Class	Role	Mult
Asso	Additional Information	Caution Area	Provides information	1,*	Nautical Information	Information provided for	0,1
Asso	Caution Area Association	Caution Area	Consists of	1,*	Archipelagic Sea Lane, Traffic Separation Scheme	Component of	0,1

16.11 Information area

IHO Definition: **INFORMATION AREA.** An area for which general information regarding navigation, but not directly related to safety of navigation, is available.

S-101 Geo Feature: Information area

Primitives: Point, Curve, Surface

Real World

Paper Chart Symbol

ECDIS Symbol

S-101 Attribute	S-57 Acronym	Allowable Encoding Value	Type	Multiplicity
Feature name			C	0,*
Display name			(S) BO	0,1
Language		ISO 639-3	(S) TE	0,1
Name	(OBJNAM) (NOBJNM)		(S) TE	1,1
Fixed date range			C	0,1
Date end	(DATEND)	ISO 8601: 2004	(S) TD	0,1
Date start	(DATSTA)	ISO 8601: 2004	(S) TD	0,1
Periodic date range			C	0,*
Date end	(PEREND)	ISO 8601: 2004	(S) TD	1,1
Date start	(PERSTA)	ISO 8601: 2004	(S) TD	1,1
Reported date	(SORDAT)	ISO 8601: 2004	TD	0,1
Scale minimum	(SCAMIN)	See clause X.X	IN	0,1

INT 1 Reference:

16.11.1 Information areas (see S-4 – B-XXX)

If it is required to encode information which may be of use to the mariner, but is not significant to safety of navigation and cannot be encoded using existing features, it must be done using the feature **Information Area**.

Remarks:

- The feature **Information Area** encodes information which the Producing Authority determines is relevant to the mariner, but does not warrant the triggering of ECDIS alarms through the encoding of **Caution Area** features.
- To encode the relevant information, an instance of the information class **Nautical Information** (see clause X.X) must be associated to the **Information Area**.
- If the information applies to a specific area the **Information Area** feature should cover only that area.
- If the information to be encoded is spatially linear, this should be encoded using a “very narrow” **Information Area** feature of type surface (approximately 0.2mm wide at the maximum display scale of the ENC data) similar to the method for encoding linear maritime jurisdiction areas (see clause X.X).

Distinction: Caution area; collision regulations limit; depth discontinuity; obstruction; underwater/awash rock; unsurveyed area; wreck.

Feature/Information associations

Type	Association	Association Ends
------	-------------	------------------

	Name	Class	Role	Mult	Class	Role	Mult
Asso	Additional Information	Information Area	Provides information	1,*	Nautical Information	Information provided for	0,1

16.12 Contiguous Zone

IHO Definition: **CONTIGUOUS ZONE.** A zone contiguous to a coastal State's Territorial Sea, which may not extend beyond 24 nautical miles from the baselines from which the breadth of the Territorial Sea is measured. The coastal state may exercise certain control in this zone subject to the provisions of International Law. (IHO Dictionary – S-32).

S-101 Geo Feature: Contiguous zone (CONZNE)

Primitives: Surface

Real World

Paper Chart Symbol

ECDIS Symbol

S-101 Attribute	S-57 Acronym	Allowable Encoding Value	Type	Multiplicity
In dispute			BO	0,1
Nationality	(NATION)		TE	1,*
Fixed date range			C	0,1
Date end	(DATEND)	ISO 8601: 2004	(S) TD	0,1
Date start	(DATSTA)	ISO 8601: 2004	(S) TD	0,1
Scale minimum	(SCAMIN)	See clause X.X	IN	0,1

INT 1 Reference: N 44

16.12.1 Contiguous Zones (see S-4 – B-440.6)

The Contiguous Zone is a zone adjacent to the Territorial Sea where the coastal state may exercise the control necessary to prevent or punish infringement of its customs, fiscal, immigration or sanitary laws and regulations within its territory or Territorial Sea. Under UNCLOS, the outer limits of this zone may not extend beyond 24 nautical miles measured from the Territorial Sea Baselines.

If it is required to encode the Contiguous Zone, it must be done using the feature **Contiguous Zone**.

Remarks:

- For guidance regarding the encoding of areas in which the maritime jurisdiction between two or more Coastal States are in dispute, see clause X.X.

Distinction: Administrative area; Continental Shelf area; Exclusive Economic Zone; fishery zone; Territorial Sea area.

16.13 Continental Shelf area

IHO Definition: **CONTINENTAL SHELF AREA.** The Continental Shelf of a coastal State comprises the seabed and subsoil of the submarine areas that extend beyond its Territorial Sea throughout the natural prolongation of its land territory to the outer edge of the continental margin, or to a distance of 200 nautical miles from the baselines from which the breadth of the Territorial Sea is measured where the outer edge of the continental margin does not extend out to that distance. (IHO Publication C-51).

S-101 Geo Feature: Continental shelf area (COSARE)

Primitives: Surface

Real World

Paper Chart Symbol

ECDIS Symbol

S-101 Attribute	S-57 Acronym	Allowable Encoding Value	Type	Multiplicity
Feature name			C	0,*
Display name			(S) BO	0,1
Language		ISO 639-3	(S) TE	0,1
Name	(OBJNAM) (NOBJNM)		(S) TE	1,1
Nationality	(NATION)		TE	1,*
Scale minimum	(SCAMIN)	See clause X.X	IN	0,1

INT 1 Reference: N 46

16.13.1 Continental Shelf (see S-4 – B-440.8)

The delineation of the Continental Shelf beyond 200 nautical miles from the Territorial Sea baselines is complex. Details are given in UNCLOS (see IHO Publication C-51). The coastal State exercises sovereign rights over the Continental Shelf for the purpose of exploring it and exploiting its natural resources. Complex procedures exist within UNCLOS for the establishment of the limits of the Continental Shelf. Where these procedures have been followed the area should be encoded on suitable maximum display scale ENC data.

If it is required to encode the Continental Shelf, it must be done using the feature **Continental Shelf Area**.

Remarks:

- No remarks.

Distinction: Administrative area; Contiguous Zone; Exclusive Economic Zone; fishery zone; Territorial Sea area.

16.14 Custom zone

IHO Definition: **CUSTOM ZONE.** The area within which national custom regulations are in force. (S-57 Edition 3.1, Appendix A – Chapter 1, Page 1.46, November 2000).

S-101 Geo Feature: Custom zone (CUSZNE)

Primitives: Surface

Real World

Paper Chart Symbol

ECDIS Symbol

S-101 Attribute	S-57 Acronym	Allowable Encoding Value	Type	Multiplicity
Nationality	(NATION)		TE	1,1
Scale minimum	(SCAMIN)	See clause X.X	IN	0,1

INT 1 Reference: N 48

16.14.1 Custom Zones (see S-4 – B-440.2)

If it is required to encode a custom zone, it must be done using the feature **Custom Zone**.

Custom zones, where details are provided by a regulatory authority, should be encoded on the largest maximum display scale ENC data covering the area.

Remarks:

- No remarks.

Distinction: Check point; free port area.

16.15 Exclusive Economic Zone

IHO Definition: **EXCLUSIVE ECONOMIC ZONE.** An area, not exceeding 200 nautical miles from the baselines from which the breadth of the Territorial Sea is measured, subject to a specific legal regime established in the United Nations Convention on the Law of the Sea under which the coastal state has certain rights and jurisdiction. (IHO Dictionary – S-32).

S-101 Geo Feature: Exclusive economic zone (EXEZNE)

Primitives: Surface

Real World

Paper Chart Symbol

ECDIS Symbol

S-101 Attribute	S-57 Acronym	Allowable Encoding Value	Type	Multiplicity
In dispute			BO	0,1
Nationality	(NATION)		TE	1,*
Scale minimum	(SCAMIN)	See clause X.X	IN	0,1

INT 1 Reference: N 47

16.15.1 Exclusive Economic Zones (see S-4 – B-440.9)

In the Exclusive Economic Zone, the coastal State has sovereign rights for the purpose of exploring and exploiting, conserving and managing the natural resources, whether living or non-living, of the waters superjacent to the seabed and of the seabed and its subsoil, and with regard to other activities for the economic exploitation and exploration of the Zone, such as the production of energy from the water, currents and winds.

If it is required to encode an Exclusive Economic Zone (EEZ), it must be done using the feature **Exclusive Economic Zone**.

Remarks:

- For guidance regarding the encoding of areas in which the maritime jurisdiction between two or more Coastal States are in dispute, see clause X.X.

Distinction: Administrative area; Contiguous Zone; Continental Shelf area; fishery zone; Territorial Sea area.

16.16 Fishery zone

IHO Definition: **FISHERY ZONE.** The offshore zone in which exclusive fishing rights and management are held by the coastal nation. (IHO Dictionary – S-32).

S-101 Geo Feature: Fishery zone (FSHZNE)

Primitives: Surface

Real World

Paper Chart Symbol

ECDIS Symbol

S-101 Attribute	S-57 Acronym	Allowable Encoding Value	Type	Multiplicity
Feature name			C	0,*
Display name			(S) BO	0,1
Language		ISO 639-3	(S) TE	0,1
Name	(OBJNAM) (NOBJNM)		(S) TE	1,1
Nationality	(NATION)		TE	1,1
Status	(STATUS)	1 : permanent 5 : periodic/intermittent 6 : reserved 7 : temporary	EN	0,*
Scale minimum	(SCAMIN)	See clause X.X	IN	0,1

INT 1 Reference: N 45

16.16.1 Fishery zones (see S-4 – B-440.7)

A fishery zone is an area inside and beyond the Territorial Sea where a coastal State proclaims that it alone may regulate fishing. Where States have permitted others to fish in parts of the area, it may be desirable to encode the area of both the full area and the area of special concessionary rights. In some instances, claims are described as “conservation zones”; for practical purposes these may be classed with fishery zones since their intended function is to institute fishery conservation measures. Most of the fishery zone claims are limited by fixed distance (200 nautical miles in some cases) from the Territorial Sea baselines.

If it is required to encode a fishery zone, it must be done using the feature **Fishery Zone**.

Remarks:

- Fishery zones commonly coincide with other national jurisdiction areas such as Continental Shelf and Exclusive Economic Zone. Where this occurs, Producing Authorities may choose to omit the **Fishery Zone** from the area covered by these other national jurisdiction areas, as the fact that fishing regulations apply in these areas is implicit.
- An indication of the fishery zone limit (for example 6 mile, 12 mile) may be encoded using the complex attribute **feature name**.

Distinction: Administrative area; Contiguous Zone; Continental Shelf area; Exclusive Economic Zone; fishing ground; restricted area navigational; restricted area regulatory; Territorial Sea area.

16.17 Fishing ground

IHO Definition: FISHING GROUND . A water area in which fishing frequently take place. (Adapted from IHO Dictionary – S-32).				
S-101 Geo Feature: Fishing ground (FSHGRD)				
Primitives: Surface				
<i>Real World</i>		<i>Paper Chart Symbol</i>		<i>ECDIS Symbol</i>
S-101 Attribute	S-57 Acronym	Allowable Encoding Value	Type	Multiplicity
Feature name			C	0,*
Display name			(S) BO	0,1
Language		ISO 639-3	(S) TE	0,1
Name	(OBJNAM) (NOBJNM)		(S) TE	1,1
Periodic date range			C	0,*
Date end	(PEREND)	ISO 8601: 2004	(S) TD	1,1
Date start	(PERSTA)	ISO 8601: 2004	(S) TD	1,1
Restriction	(RESTRN)	1 : anchoring prohibited 2 : anchoring restricted 4 : fishing restricted 5 : trawling prohibited 6 : trawling restricted 8 : entry restricted 9 : dredging prohibited 10 : dredging restricted 11 : diving prohibited 12 : diving restricted 15 : construction prohibited 16 : discharging prohibited 17 : discharging restricted 18 : industrial or mineral exploration/development prohibited 19 : industrial or mineral exploration/development restricted 20 : drilling prohibited 21 : drilling restricted 22 : removal of historical artefacts prohibited 23 : cargo transshipment (lightening) prohibited 24 : dragging prohibited 25 : stopping prohibited 26 : landing prohibited 27 : speed restricted 39 : swimming prohibited	EN	0,*
Status	(STATUS)	1 : permanent 5 : periodic/intermittent 6 : reserved 7 : temporary 8 : private	EN	0,*

		14 : public 16 : watched 17 : un-watched 28 : buoyed		
Scale minimum	(SCAMIN)	See clause X.X	IN	0,1
<p><u>INT 1 Reference:</u></p> <p>16.17.1 Fishing grounds</p> <p>If it is required to encode a fishing ground, it must be done using the feature Fishing Ground.</p> <p><u>Remarks:</u></p> <ul style="list-style-type: none"> • No remarks. <p><u>Distinction:</u> Fishery zone; marine farm/culture.</p>				

16.18 Free port area

IHO Definition: **FREE PORT AREA.** A port where certain import and export duties are waived (unless goods pass into the country) to facilitate reshipment to other countries. (IHO Dictionary – S-32).

S-101 Geo Feature: Free port area (FRPARE)

Primitives: Surface

Real World

Paper Chart Symbol

ECDIS Symbol

S-101 Attribute	S-57 Acronym	Allowable Encoding Value	Type	Multiplicity
Feature name			C	0,*
Display name			(S) BO	0,1
Language		ISO 639-3	(S) TE	0,1
Name	(OBJNAM) (NOBJNM)		(S) TE	1,1
Status	(STATUS)	1 : permanent 6 : reserved 8 : private 14 : public	EN	0,*
Scale minimum	(SCAMIN)	See clause X.X	IN	0,1

INT 1 Reference:

16.18.1 Free port areas

If it is required to encode a free port area, it must be done using the feature **Free Port Area**.

Remarks:

- No remarks.

Distinction: Custom zone; production/storage area.

16.19 Harbour area (administrative)

IHO Definition: **HARBOUR AREA.** The area over which a harbour authority has jurisdiction. (S-57 Edition 3.1, Appendix A – Chapter 1, Page 1.80, November 2000).

S-101 Geo Feature: Harbour area (administrative) (HRBARE)**Primitives: Surface***Real World**Paper Chart Symbol**ECDIS Symbol*

S-101 Attribute	S-57 Acronym	Allowable Encoding Value	Type	Multiplicity
Feature name			C	0,*
Display name			(S) BO	0,1
Language		ISO 639-3	(S) TE	0,1
Name	(OBJNAM) (NOBJNM)		(S) TE	1,1
Status	(STATUS)	1 : permanent 4 : not in use 6 : reserved 8 : private 14 : public	EN	0,*
Scale minimum	(SCAMIN)	See clause X.X	IN	0,1

INT 1 Reference: N 49

16.19.1 Administrative harbour areas (see S-4 – B-430.1)

Administrative harbour areas must be shown on at least the largest maximum display scale ENC datasets, where possible, to assist mariners in complying with harbour regulations.

If it is required to encode an administrative harbour area, it must be done using the feature **Harbour Area (Administrative)**.

Remarks:

- If it is required to encode a named harbour area over which there is no jurisdictional authority, it must be done using the feature **Sea Area/Named Water Area** (see clause X.X).
- A masked line may be used to suppress the symbolisation of the boundary, where such symbolisation is considered inappropriate.

Distinction: Dock area; sea area/named water area.

16.20 Log pond

IHO Definition: **LOG POND.** A maritime area enclosed with connected floating timbers used as a staging area for sawn logs. (S-57 Edition 3.1, Appendix A – Chapter 1, Page 1.102, November 2000).

S-101 Geo Feature: Log pond (LOGPON)

Primitives: Point, Surface

Real World

Paper Chart Symbol

ECDIS Symbol

S-101 Attribute	S-57 Acronym	Allowable Encoding Value	Type	Multiplicity
Feature name			C	0,*
Display name			(S) BO	0,1
Language		ISO 639-3	(S) TE	0,1
Name	(OBJNAM) (NOBJNM)		(S) TE	1,1
Periodic date range			C	0,*
Date end	(PEREND)	ISO 8601: 2004	(S) TD	1,1
Date start	(PERSTA)	ISO 8601: 2004	(S) TD	1,1
Status	(STATUS)	1 : permanent 2 : occasional 5 : periodic/intermittent 6 : reserved 7 : temporary 8 : private	EN	0,*
Scale minimum	(SCAMIN)	See clause X.X	IN	0,1

INT 1 Reference: N 61

16.20.1 Log ponds (see S-4 – B-449.2)

If it is required to encode a log pond (also known as booming ground), it must be done using the feature **Log Pond**.

Remarks:

- Seasonal log ponds should be encoded using the complex attribute **periodic date range**.
- It is not required to separately encode any posts, piles or other log pond barrier supports.

Distinction:

16.21 Oil barrier

IHO Definition: **OIL BARRIER.** A floating barrier to stop and contain the spread of oil on a water body surface. (Defence Geospatial Information Working Group; Feature Data Dictionary Register, 2010).

S-101 Geo Feature: Oil barrier (OILBAR)

Primitives: Curve

Real World

Paper Chart Symbol

ECDIS Symbol

S-101 Attribute	S-57 Acronym	Allowable Encoding Value	Type	Multiplicity
Category of oil barrier	(CATOLB)	1 : oil retention (high pressure pipe) 2 : floating oil barrier	EN	0,1
Condition	(CONDTN)	1 : under construction 2 : ruined 5 : planned construction	EN	0,1
Feature name			C	0,*
Display name			(S) BO	0,1
Language		ISO 639-3	(S) TE	0,1
Name	(OBJNAM) (NOBJNM)		(S) TE	1,1
Fixed date range			C	0,1
Date end	(DATEND)	ISO 8601: 2004	(S) TD	0,1
Date start	(DATSTA)	ISO 8601: 2004	(S) TD	0,1
Reported date	(SORDAT)	ISO 8601: 2004	TD	0,1
Status	(STATUS)	1 : permanent 2 : occasional 4 : not in use 5 : periodic/intermittent 7 : temporary 8 : private	EN	0,*
Scale minimum	(SCAMIN)	See clause X.X	IN	0,1

INT 1 Reference: F 29

16.21.1 Oil barriers (see S-4 – B-449.2)

If it is required to encode an oil barrier, it must be done using the feature **Oil Barrier**.

Remarks:

- No remarks.

Distinction:

16.22 Straight Territorial Sea Baseline

IHO Definition: **STRAIGHT TERRITORIAL SEA BASELINE.** A baseline is the line from which the outer limits of the Territorial Sea and certain other outer limits are measured. (IHO Dictionary – S-32).

Straight baselines are a system of straight lines joining specified or discrete points on the low-water line, usually known as straight baseline turning points. (IHO Dictionary – S-32).

S-101 Geo Feature: Straight territorial sea baseline (STSLNE)

Primitives: Curve

Real World

Paper Chart Symbol

ECDIS Symbol

S-101 Attribute	S-57 Acronym	Allowable Encoding Value	Type	Multiplicity
Nationality	(NATION)		TE	1,1
Scale minimum	(SCAMIN)	See clause X.X	IN	0,1

INT 1 Reference: N 42

16.22.1 Straight Territorial Sea Baselines (see S-4 – B-440.4)

A Territorial Sea is delimited by:

- Territorial Sea Baselines (drying lines);
- Straight Territorial Sea Baselines;
- International maritime boundaries (see clause X.X); and
- Seaward limits of Territorial Seas (see clause X.X).

The term “Baseline” refers to the line from which the breadth of the Territorial Sea, the outer limits of the Contiguous Zone, the Exclusive Economic Zone and, in some cases, the Continental Shelf are measured. It is also the dividing line between internal waters and territorial seas. Internal waters comprise all areas of the sea on the landward side of the Territorial Sea Baselines, as well as inland waters including rivers, lakes, etc.

The normal baseline is the low water line (which is not defined any more precisely by UNCLOS) of the mainland, islands, or low tide elevations, as depicted on large scale charts officially recognised by the coastal State; they therefore do not require depiction in ENCs. Features which are naturally-formed and dry at low water (for example rocks, reefs, sand banks) may be considered low-tide elevations and included in the baseline (details are given in UNCLOS - see IHO publication C-51).

A straight baseline may be used:

- as a closing line across the mouth or estuary of a river;
- as a closing line across the mouth of a juridical bay or a historical bay;
- as part of a system of Straight Territorial Sea Baselines, for example to connect seaward points on a deeply indented coastline, a coastline that is fringed with islands, around unstable coastlines; or
- as an archipelagic baseline.

If it is required to encode a Straight Territorial Sea Baseline, it must be done using the feature **Straight Territorial Sea Baseline**.

Remarks:

- No remarks.

Distinction:

16.23 Territorial Sea area

IHO Definition: **TERRITORIAL SEA AREA.** A belt of water of a defined breadth but not exceeding 12 nautical miles measured seaward from the Territorial Sea Baseline. (IHO Dictionary – S-32).

S-101 Geo Feature: Territorial sea area (TESARE)

Primitives: Surface

<i>Real World</i>	<i>Paper Chart Symbol</i>	<i>ECDIS Symbol</i>
-------------------	---------------------------	---------------------

S-101 Attribute	S-57 Acronym	Allowable Encoding Value	Type	Multiplicity
In dispute			BO	0,1
Nationality	(NATION)		TE	1,*
Restriction	(RESTRN)	2 : anchoring restricted 4 : fishing restricted 6 : trawling restricted 8 : entry restricted 9 : dredging prohibited 10 : dredging restricted 12 : diving restricted 17 : discharging restricted 18 : industrial or mineral exploration/development prohibited 19 : industrial or mineral exploration/development restricted 20 : drilling prohibited 21 : drilling restricted 22 : removal of historical artefacts prohibited 23 : cargo transhipment (lightening) prohibited 24 : dragging prohibited 27 : speed restricted	EN	0,*
Scale minimum	(SCAMIN)	See clause X.X	IN	0,1

INT 1 Reference: N 43

16.23.1 Territorial Seas (see S-4 – B-440.5)

A Territorial Sea is delimited by:

- Territorial Sea Baselines (drying lines);
- Straight Territorial Sea Baselines (see clause **X.X**);
- International maritime boundaries (see clause **X.X**); and
- Seaward limits of Territorial Seas.

Within the Territorial Sea, a coastal State exercises sovereignty subject to rules of international law, including the right of innocent passage for foreign ships.

If it is required to encode a Territorial Sea area, it must be done using the feature **Territorial Sea Area**.

Remarks:

- For guidance regarding the encoding of areas in which the maritime jurisdiction between two or more Coastal States are in dispute, see clause **X.X**.

Distinction: Administrative area; Contiguous Zone; Continental Shelf area; Exclusive Economic Zone; fishery

zone; restricted area navigational; restricted area regulatory.

16.24 Submarine transit lane

IHO Definition: **SUBMARINE TRANSIT LANE.** A lane where submarines may navigate under water or at the surface. (IHO Dictionary – S-32).

S-101 Geo Feature: Submarine transit lane (SUBTLN)

Primitives: Surface

<i>Real World</i>	<i>Paper Chart Symbol</i>	<i>ECDIS Symbol</i>
-------------------	---------------------------	---------------------

S-101 Attribute	S-57 Acronym	Allowable Encoding Value	Type	Multiplicity
Feature name			C	0,*
Display name			(S) BO	0,1
Language		ISO 639-3	(S) TE	0,1
Name	(OBJNAM) (NOBJNM)		(S) TE	1,1
Nationality	(NATION)		TE	0,1
Restriction	(RESTRN)	1 : anchoring prohibited 2 : anchoring restricted 3 : fishing prohibited 4 : fishing restricted 5 : trawling prohibited 6 : trawling restricted 7 : entry prohibited 8 : entry restricted 9 : dredging prohibited 10 : dredging restricted 11 : diving prohibited 12 : diving restricted 13 : no wake 16 : discharging prohibited 17 : discharging restricted 18 : industrial or mineral exploration/development prohibited 19 : industrial or mineral exploration/development restricted 20 : drilling prohibited 21 : drilling restricted 22 : removal of historical artefacts prohibited 23 : cargo transhipment (lightening) prohibited 24 : dragging prohibited 25 : stopping prohibited 27 : speed restricted	EN	0,*
Scale minimum	(SCAMIN)	See clause X.X	IN	0,1

INT 1 Reference: N 33

16.24.1 Submarine transit lanes (see S-4 – B-441.5)

Submarine transit lanes should not generally be encoded because submarines exercise over wide areas which it would not be practicable to depict, and over which cautions (to keep a good look out for them) are unlikely to

be effective. They may, however, be encoded where they occur in or near major shipping lanes or port approaches.

If it is required to encode a submarine transit lane, it must be done using the feature **Submarine Transit Lane**.

Remarks:

- No remarks.

Distinction: Military practice area.

16.25 Pilotage district

IHO Definition: **PILOTAGE DISTRICT.** An area within which a pilotage direction exists. Such directions are regulated by a competent harbour authority which dictates circumstances under which they apply. (UK Pilotage Act 1987).

S-101 Geo Feature: Pilotage district

Primitives: Surface

Real World

Paper Chart Symbol

ECDIS Symbol

S-101 Attribute	S-57 Acronym	Allowable Encoding Value	Type	Multiplicity
Communication channel	(COMCHA)		TE	0,*
Feature name			C	0,*
Display name			(S) BO	0,1
Language		ISO 639-3	(S) TE	0,1
Name	(OBJNAM) (NOBJNM)		(S) TE	1,1
Scale minimum	(SCAMIN)	See clause X.X	IN	0,1

INT 1 Reference:

16.25.1 Pilotage districts (see S-4 – B-XXX)

If it is required to encode the area within which regulations regarding pilotage apply it should be done using the feature **Pilotage District**.

Remarks:

- To encode the relevant regulations, an instance of the information class **Nautical Information** (see clause X.X) must be associated to the **Pilotage District**.
- Where the limit of pilotage regulations are coincident with harbour or port limits it is not required to encode a **Pilotage District** feature.
- The relationship between the pilotage district and any associated pilot boarding places should be encoded using the feature association **Pilotage District Association** (see clause X.X).

Distinction: Pilot boarding place.

Feature/Information associations

Type	Association Name	Association Ends					
		Class	Role	Mult	Class	Role	Mult
Asso	Pilotage district association	Pilotage District	Component of	0,1	Pilot Boarding Place	Consists of	1,*

16.26 Collision regulations limit

IHO Definition: **COLLISION REGULATIONS LIMIT.** Convention on the International Regulations for Preventing Collisions at Sea, 1972 (COLREGs). The demarcation line between inland navigation rules and international navigation rules.

S-101 Geo Feature: Collision regulations limit

Primitives: Curve

Real World

Paper Chart Symbol

ECDIS Symbol

S-101 Attribute	S-57 Acronym	Allowable Encoding Value	Type	Multiplicity
Feature name			C	0,*
Display name			(S) BO	0,1
Language		ISO 639-3	(S) TE	0,1
Name	(OBJNAM) (NOBJNM)		(S) TE	1,1
Fixed date range			C	0,1
Date end	(DATEND)	ISO 8601: 2004	(S) TD	0,1
Date start	(DATSTA)	ISO 8601: 2004	(S) TD	0,1
Periodic date range			C	0,*
Date end	(PEREND)	ISO 8601: 2004	(S) TD	1,1
Date start	(PERSTA)	ISO 8601: 2004	(S) TD	1,1
Regulation citation			TE	0,1
Scale minimum	(SCAMIN)	See clause X.X	IN	0,1

INT 1 Reference:

16.26.1 Collision regulations limit (see S-4 – B-XXX)

If it is required to encode a collision regulations (COLREGs) demarcation line, it must be done using the feature **Collision Regulations Limit**.

Remarks:

- If it is required to encode the national regulation citation it must be done using the attribute **regulation citation**.

Distinction: Administrative area.

17 Geo Features – Restricted Areas – Overview

There are many types of areas within which certain activities are discouraged or prohibited, or from which certain classes of vessels are excluded. The general term for all areas in which certain aspects of navigation may be restricted or prohibited by regulations is “Restricted Area”, or equivalent. The word “prohibited”, or its equivalent, may appear in terms relating to activities which are contrary to the regulations, for example “Anchoring Prohibited”, “Entry Prohibited”.

If it is required to encode a restricted area, it must be done using the features **Restricted Area Navigational** (see clause X.X) or **Restricted Area Regulatory** (see clause X.X); or using other features having the attribute **restriction** (**Anchorage Area, Cable Area, Dumping Ground, Dredged Area, Deep Water Route Part, Fairway, Fishing Ground, Harbour Facility, Inshore Traffic Zone, Marine Farm/Culture, Military Practice Area, Offshore Production Area, Submarine Pipeline Area, Pipeline Submarine/On Land, Precautionary Area, Seaplane Landing Area, Submarine Transit Lane, Territorial Sea Area, Traffic Separation Scheme Crossing, Traffic Separation Scheme Lane Part, Traffic Separation Scheme Roundabout**).

The determination of whether a particular restricted area is navigational or regulatory in nature is characterised by the type(s) of restrictions that are in place within the area, as listed as allowable values for the attribute **restriction** for the **Restricted Area Navigational** or **Restricted Area Regulatory**. **Restricted Area Navigational** must only be encoded if one of the allowable values for **restriction** apply for the area.

Remarks:

- The attribute **category of restricted area** is used to describe the reason for the regulation, while the attribute **restriction** describes the restrictions.
- If an area is subject to both navigational and regulatory restrictions, and instance of both features **Restricted Area Navigational** and **Restricted Area Regulatory** should be encoded.
- An associated instance of the information class **Nautical Information** (see clause X.X), complex attribute **information** may be used to provide an additional explanation about the regulation (for example a caution note from a paper chart), where required.
- An area in which regulations apply due to recreation activities such as water skiing, jet skiing, kite surfing and rowing must be encoded, where required, as **Restricted Area Navigational** or **Restricted Area Regulatory** with **category of restriction** = 32 (recreation area).
- If it is required to encode an area for which the mariner must be made aware of circumstances influencing the safety of navigation, it must be done using the feature **Caution Area** (see clause X.X). This feature may be used to identify a danger, a risk, a rule or advice (for example an area of continually changing depths) which is not directly related to a particular feature.

17.1 Minefields (see S-4 – B-441.8)

If it is required to encode a minefield, it must be done using a **Restricted Area Navigational** feature (see clause X.X) or **Restricted Area Regulatory** feature (see clause X.X), with attribute **category of restricted area** = 14 (minefield). Former mined areas should also be encoded with attribute **status** = 4 (not in use).

17.2 Degaussing ranges (see S-4 – B-448)

A degaussing (or demagnetising) range is an area, usually of about 0.2M diameter, within which ships’ magnetic fields may be measured. Sensing instruments and cables are installed on the sea floor in the range and there are cables leading from the range to a control position ashore. The range is usually marked by distinctive buoys. The significance of a degaussing range to mariners is that anchoring and trawling are prohibited and that the range may have to be avoided when vessels are using it.

If it is required to encode a degaussing range, it must be done using a **Restricted Area Navigational** feature (see clause X.X) or **Restricted Area Regulatory** feature (see clause X.X), with attribute **category of restricted area** = 8 (degaussing range).

17.3 Nature reserves (see S-4 – B-437.3)

If it is required to encode a marine nature reserve area, it must be done using a **Restricted Area Navigational** feature (see clause X.X) or **Restricted Area Regulatory** feature (see clause X.X), with attribute **category of restricted area** = 4 (nature reserve).

17.4 Speed limits (see S-4 – B-430.2)

Speed is often limited inside harbours in order to prevent wakes. If it is required to encode this restriction, it must be done using a **Restricted Area Navigational** feature (see clause X.X), with the attribute **category of restricted area** = 24 (no wake area) or **restriction** = 13 (no wake). If it is required to encode cases where the speed limit is known, it must be done using **restriction** = 27 (speed restricted), with the speed limit and its unit of measurement encoded using an associated instance of the information class **Nautical Information** (see clause X.X), complex attribute **information**, sub-attribute **text** (for example *Speed limit is 5 knots*).

If it is required to encode the buoys/beacons marking the **Restricted Area Navigational** feature with speed limits, it must be done using **Beacon Special Purpose/General** or **Buoy Special Purpose/General** features (see clauses X.X and X.X), with the attribute **category of special purpose mark** = 24 (“reduced wake” mark) or 25 (speed limit mark). The speed limit and its unit of measurement should be encoded using an associated instance of the information class **Nautical Information** (see clause X.X), complex attribute **information**, sub-attribute **text** (for example *Speed limit is 6 knots*).

17.5 Anchoring restricted (see S-4 – B-431.4)

If it is required to encode a restricted anchoring area, it must be done using a **Restricted Area Regulatory** feature (see clause X.X), or using other features with the attribute **restriction** (see clause X.X), where **restriction** = 1 (anchoring prohibited) or 2 (anchoring restricted). Additional information about the restriction should be encoded using an associated instance of the information class **Nautical Information** (see clause X.X), complex attribute **information**.

17.6 Areas to be avoided (see S-4 – B-435.7)

If it is required to encode an IMO designated Area to be Avoided, it must be done using a **Restricted Area Navigational** feature (see clause X.X), with attribute **restriction** = 14 (area to be avoided). An area to be avoided around a navigational aid must also be encoded with attribute **category of restricted area** = 12 (navigational aid safety zone).

17.7 Environmentally Sensitive Sea Areas (see S-4 – B-437)

Environmentally Sensitive Sea Areas (ESSA) should be included on ENC data where there is a specifically identified requirement, and where it is practicable, given the maximum display scale of the ENC data and the extent of the ESSA. If there is no such requirement, or if it is not practicable, details of ESSA should only be inserted in associated publications, such as Sailing Directions. It should be noted that the inclusion of ESSA on smaller maximum display scale of the ENC data may be appropriate for voyage planning purposes.

If it is required to encode an Environmentally Sensitive Sea Area, it must be done using a **Restricted Area Navigational** feature (see clause X.X) or **Restricted Area Regulatory** feature (see clause X.X), with attribute **category of restricted area** = 27 (ESSA) or 28 (PSSA).

An Environmentally Sensitive Sea Area that is shown on the source as a point symbol should be encoded using a small surface restricted area feature.

17.8 Restricted area navigational

IHO Definition: RESTRICTED AREA. A specified area on land or water designated by an appropriate authority within which access or navigation is restricted in accordance with certain specified conditions. (Adapted from IHO Dictionary – S-32).

A navigational restricted area is an area where the restrictions have a direct impact on the navigation of a vessel in the area.

S-101 Geo Feature: Restricted area navigational (RESARE)

Primitives: Surface

Real World

Paper Chart Symbol

ECDIS Symbol

S-101 Attribute	S-57 Acronym	Allowable Encoding Value	Type	Multiplicity
Category of restricted area	(CATREA)	1 : offshore safety zone 4 : nature reserve 5 : bird sanctuary 6 : game reserve 7 : seal sanctuary 8 : degaussing range 9 : military area 10 : historic wreck area 12 : navigational aid safety zone 14 : minefield 18 : swimming area 19 : waiting area 20 : research area 21 : dredging area 22 : fish sanctuary 23 : ecological reserve 24 : no wake area 25 : swinging area 27 : environmentally sensitive sea area 28 : particularly sensitive sea area 29 : disengagement area 30 : port security area 31 : coral sanctuary 32 : recreation area	EN	0,*
Feature name			C	0,*
Display name			(S) BO	0,1
Language		ISO 639-3	(S) TE	0,1
Name	(OBJNAM) (NOBJNM)		(S) TE	1,1
Fixed date range			C	0,1
Date end	(DATEND)	ISO 8601: 2004	(S) TD	0,1
Date start	(DATSTA)	ISO 8601: 2004	(S) TD	0,1
Periodic date range			C	0,*
Date end	(PEREND)	ISO 8601: 2004	(S) TD	1,1

Date start	(PERSTA)	ISO 8601: 2004	(S) TD	1,1
Restriction	(RESTRN)	1 : anchoring prohibited 2 : anchoring restricted 7 : entry prohibited 8 : entry restricted 13 : no wake 14 : area to be avoided 25 : stopping prohibited 26 : landing prohibited 27 : speed restricted	EN	1,*
Scale minimum	(SCAMIN)	See clause X.X	IN	0,1
Status	(STATUS)	1 : permanent 2 : occasional 3 : recommended 4 : not in use 5 : periodic/intermittent 6 : reserved 7 : temporary 9 : mandatory 18 : existence doubtful 28 : buoyed	EN	0,*
Vessel speed limit			C	0,*
Speed limit			(S) RE	1,1
Vessel class			(S) TE	0,1

INT 1 Reference: L 3; M 29.1; N 2.1-2, 20-22, 25, 34, 63

17.8.1 Navigational restricted areas (see S-4 – B-422; B-430.2; B-431.4; B-435.7; B-435.11; B-437.1-7; B-439; B-439.2-4; B-441,1; B-445.9; B-445.11-12; B-446.4 and B-448.1)

If it is required to encode a navigational restricted area, it must be done using the feature **Restricted Area Navigational**, or using other features having the attribute **restriction** (**Anchorage Area**, **Cable Area**, **Dumping Ground**, **Dredged Area**, **Deep Water Route Part**, **Fairway**, **Fishing Ground**, **Harbour Facility**, **Inshore Traffic Zone**, **Marine Farm/Culture**, **Military Practice Area**, **Offshore Production Area**, **Submarine Pipeline Area**, **Pipeline Submarine/On Land**, **Precautionary Area**, **Seaplane Landing Area**, **Submarine Transit Lane**, **Territorial Sea Area**, **Traffic Separation Scheme Crossing**, **Traffic Separation Scheme Lane Part**, **Traffic Separation Scheme Roundabout**).

Remarks:

- **Restricted Area Navigational** must only be encoded if one of the allowable values for **restriction** apply for the area.
- The term “no anchoring area” is used to identify the IMO routing measure of that name. Such areas, where required, must be encoded as **Restricted Area Navigational** with attribute **restriction = 1** (anchoring prohibited).

Distinction: Anchorage area; cable area; caution area; collision regulations limit; Deep Water route part; depth area; dredged area; dumping ground; fairway; information area; military practice area; restricted area regulatory; submarine pipeline area; swept area.

Feature/Information associations

Type	Association Name	Association Ends					
		Class	Role	Mult	Class	Role	Mult
Aggr	Traffic Separation Scheme Aggregation	Restricted Area Navigational	Consists of	1,*	Traffic Separation Scheme	Component of	0,1

17.9 Restricted area regulatory

IHO Definition: RESTRICTED AREA. A specified area on land or water designated by an appropriate authority within which access or navigation is restricted in accordance with certain specified conditions. (Adapted from IHO Dictionary – S-32).

A regulatory restricted area is an area where the restrictions have no direct impact on the navigation of a vessel in the area, but impact on the activities that can take place within the area.

S-101 Geo Feature: Restricted area regulatory (RESARE)

Primitives: Surface

<i>Real World</i>	<i>Paper Chart Symbol</i>	<i>ECDIS Symbol</i>
-------------------	---------------------------	---------------------

S-101 Attribute	S-57 Acronym	Allowable Encoding Value	Type	Multiplicity
Category of restricted area	(CATREA)	1 : offshore safety zone 4 : nature reserve 5 : bird sanctuary 6 : game reserve 7 : seal sanctuary 8 : degaussing range 9 : military area 10 : historic wreck area 12 : navigational aid safety zone 14 : minefield 18 : swimming area 19 : waiting area 20 : research area 21 : dredging area 22 : fish sanctuary 23 : ecological reserve 25 : swinging area 27 : environmentally sensitive sea area 28 : particularly sensitive sea area 29 : disengagement area 30 : port security area 31 : coral sanctuary 32 : recreation area	EN	0,*
Feature name			C	0,*
Display name			(S) BO	0,1
Language		ISO 639-3	(S) TE	0,1
Name	(OBJNAM) (NOBJNM)		(S) TE	1,1
Fixed date range			C	0,1
Date end	(DATEND)	ISO 8601: 2004	(S) TD	0,1
Date start	(DATSTA)	ISO 8601: 2004	(S) TD	0,1
Periodic date range			C	0,*
Date end	(PEREND)	ISO 8601: 2004	(S) TD	1,1
Date start	(PERSTA)	ISO 8601: 2004	(S) TD	1,1

Restriction	(RESTRN)	3 : fishing prohibited 4 : fishing restricted 5 : trawling prohibited 6 : trawling restricted 9 : dredging prohibited 10 : dredging restricted 11 : diving prohibited 12 : diving restricted 15 : construction prohibited 16 : discharging prohibited 17 : discharging restricted 18 : industrial or mineral exploration/development prohibited 19 : industrial or mineral exploration/development restricted 20 : drilling prohibited 21 : drilling restricted 22 : removal of historical artefacts prohibited 23 : cargo transshipment (lightening) prohibited 24 : dragging prohibited 39 : swimming prohibited	EN	0,*
Scale minimum	(SCAMIN)	See clause X.X	IN	0,1
Status	(STATUS)	1 : permanent 2 : occasional 3 : recommended 4 : not in use 5 : periodic/intermittent 6 : reserved 7 : temporary 9 : mandatory 18 : existence doubtful 28 : buoyed	EN	0,*
Vessel speed limit			C	0,*
Speed limit			(S) RE	1,1
Vessel class			(S) TE	0,1

INT 1 Reference: L 3; N 21-22, 25, 31, 34, 63

17.9.1 Restricted areas in general (see S-4 – B-422; B-437.1-7; B-439; B-441.1; B-439.2-4; B-445.9; B-445.11-12; B-446.4 and B-448.1)

If it is required to encode a regulatory restricted area, it must be done using the feature **Restricted Area Regulatory**, or using other features having the attribute **restriction (Anchorage Area, Cable Area, Dumping Ground, Dredged Area, Deep Water Route Part, Fairway, Fishing Ground, Harbour Facility, Inshore Traffic Zone, Marine Farm/Culture, Military Practice Area, Offshore Production Area, Pipeline Submarine/On Land, Precautionary Area, Seaplane Landing Area, Submarine Pipeline Area, Submarine Transit Lane, Territorial Sea Area, Traffic Separation Scheme Crossing, Traffic Separation Scheme Lane Part, Traffic Separation Scheme Roundabout)**.

Remarks:

- No remarks.

Distinction: Anchorage area; cable area; caution area; collision regulations limit; Deep Water route part; depth area; dredged area; dumping ground; fairway; information area; military practice area; restricted area navigational; submarine pipeline area; swept area.

Feature/Information associations

Type	Association Name	Association Ends					
		Class	Role	Mult	Class	Role	Mult
Aggr	Traffic Separation Scheme Aggregation	Restricted Area Regulatory	Consists of	1,*	Traffic Separation Scheme	Component of	0,1

18 Geo Features – Aids to Navigation – Overview

18.1 Geo features forming parts of navigational aids

Aids to navigation are composed of fixed or floating structure features established specifically as an aid to navigation, which may carry equipment features.

When identifying relationships (associations) between aids to navigation and associated geo features within this document, three “base classes” are used to define the aids to navigation geo features included in the relevant association. These “base classes” are:

- **Structure Features:** Includes **Beacon Cardinal, Beacon Isolated Danger, Beacon Lateral, Beacon Safe Water, Beacon Special Purpose/General, Buoy Cardinal, Buoy Emergency Wreck Marking; Buoy Installation, Buoy Isolated Danger, Buoy Lateral, Buoy Safe Water, Buoy Special Purpose/General, Daymark, Light Float, Light Vessel, Landmark, Pile.**
- **Equipment Features:** Includes **Daymark, Fog Signal, Light Air Obstruction, Light All Around, Light Fog Detector, Light Sector, Physical AIS Aid to Navigation, Radar Reflector, Radar Transponder Beacon, Retroreflector, Signal Station Traffic, Signal Station Warning.**
- **Navigational Aid Features:** Includes **Beacon Cardinal, Beacon Isolated Danger, Beacon Lateral, Beacon Safe Water, Beacon Special Purpose/General, Buoy Cardinal, Buoy Emergency Wreck Marking; Buoy Installation, Buoy Isolated Danger, Buoy Lateral, Buoy Safe Water, Buoy Special Purpose/General, Daymark, Light Float, Light Vessel, Pile.**

The encoding of relationships between structure and equipment features is described in clause **X.X**.

Remarks:

- Structures that have not been established specifically as an aid to navigation may also carry aids to navigation as equipment features. These include **Bridge, Building, Cable Overhead, Conveyor, Crane, Floating Dock, Fortified Structure, Fishing Facility, Hulk, Landmark, Mooring/Warping Facility, Offshore Platform, Pipeline Overhead, Pontoon, Pylon/Bridge Support, Obstruction, Shoreline Construction, Silo/Tank, Span Fixed, Span Opening, Wind Turbine, Wreck.** If it is required to encode such supporting structures at the same location as an equipment feature, it must be encoded as a separate feature, and share the same spatial type as (for point structures), or cover the location of (for structures of type curve or area) the equipment feature.
- Radar reflectors must not be encoded as separate features when attached to navigational aids. If it is required to encode their existence, it must be done by populating the Boolean attribute **radar conspicuous = True.**
- Rescue stations and coast guard stations are not related to navigation, and they must not, therefore, be part of the equipment features of navigational aids. If it is required to encode a rescue or coast guard station at the same location as a navigational mark, it must be encoded as a separate feature, and share the same spatial type as the navigational aid.

18.2 Relationships

A **Structure/Equipment** feature association (see clause **X.X**) must be created in order to relate the different features comprising a navigational aid. Where a **Structure/Equipment** feature association is created, there must be only one structure feature related to one or more equipment features. An equipment feature must not be related to more than one structure feature, and a feature must not be both a structure and an equipment feature.

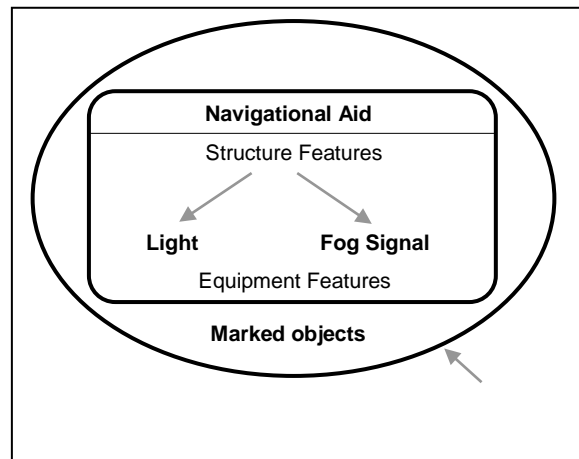

Navigational Aids – Structure/Equipment Association

Note that **Daymark** may be a structure feature or an equipment feature (refer to the lists of structure and equipment features at clause X.X); where a navigational aid contains a **Daymark** and there is no other base structure (which can serve as the master feature) indicated on the source, the **Daymark** feature should be encoded as the master feature.

When the nature of the base structure on land is unknown or there is no structure feature, one of the equipment features may be chosen as the structure feature, giving priority to a **Light** feature, if one exists. Alternatively, a **Pile** feature of type point or a **Beacon Special Purpose/General** feature may be encoded as the structure feature at the same position as the equipment features. When a light is located in the water with no indication on the source of the structure feature, regardless of the height of the light, a **Pile** feature of type surface or a **Beacon Special Purpose/General** feature should be encoded as the structure feature. This will ensure that a symbol will be shown on ECDIS systems when the light features are not displayed during daytime navigation.

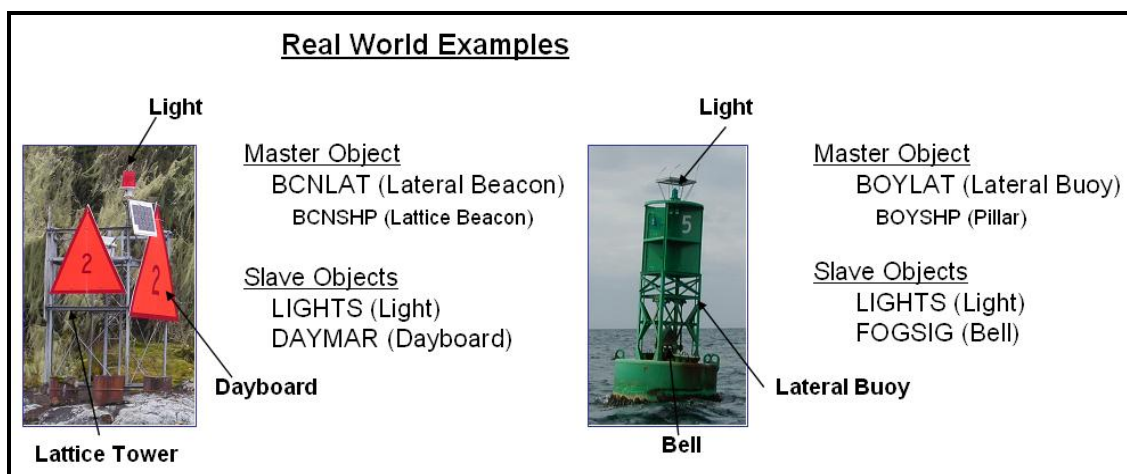

Navigational Aids – Structure/equipment Feature Associations: Real World Examples

In the above real world examples, the structure and equipment features that make up the navigational aids are point spatial types, and they must share the same geographic point spatial type.

If it is required to encode the name of the navigational aid, it must be done using the complex attribute **feature name** on the structure feature. The name must not be repeated for the equipment features. If the name is painted on the structure, it must be encoded with the same spelling in the complex attribute **feature name** (sub-attribute **name**, no value populated for sub-attribute **language**) if it is based on the Latin alphabet. If the name is not based on the Latin alphabet, it must be encoded using **feature name (name)**, with an appropriate value populated for the sub-attribute **language**, and transliterated for encoding on an iteration of **feature name (name)** with no value populated for **language**.

All point features comprising a navigational aid must share the same geographic point spatial instance.

18.3 Buoyage systems and direction of buoyage (see S-4 – B-461)

Systems of buoyage are described as lateral, cardinal, or a combination of lateral and cardinal. Lateral systems depend on a direction of buoyage being defined. The cardinal system depends solely on the main points of the compass. Special purpose buoys often mark the limits or centre of an area (for example an exercise area, a dumping ground) and do not necessarily have lateral or cardinal system characteristics.

The IALA Maritime Buoyage System details, including the extent of Regions A and B, are given in other publications (for example UK's booklet NP 735 "IALA Maritime Buoyage System"). Although it is called a buoyage system, it applies to all fixed and floating marks except lighthouses, some sector lights, leading lights and marks, major floating lights and lights on offshore structures. Six types of marks are provided by the system: Lateral, Cardinal, Isolated danger, Safe water, Special and Emergency Wreck Marking marks, which may be used in any combination.

18.3.1 Buoyage systems and direction of buoyage (see S-4 – B-461)

The buoyage system of the area covered by the dataset and, where necessary, the direction of buoyage, must be encoded using the meta features **Navigational System of Marks** and **Local Direction of Buoyage**:

All parts of the dataset containing data must be covered by **Navigational System of Marks** features (see clause X.X), with the mandatory attribute **marks navigational – system of** indicating the buoyage system in operation. **Navigational System of Marks** features must not overlap.

Within a dataset, there may be some areas where the direction of buoyage is defined by local rules and must, therefore, be specified. These areas should be encoded as separate **Local Direction of Buoyage** features (see clause X.X), with the mandatory complex attribute **orientation** indicating the direction of buoyage. **Local Direction of Buoyage** features must not overlap, but in areas where local buoyage directions apply, **Local Direction of Buoyage** features must overlap **Navigational System of Marks** features (see Figure below).

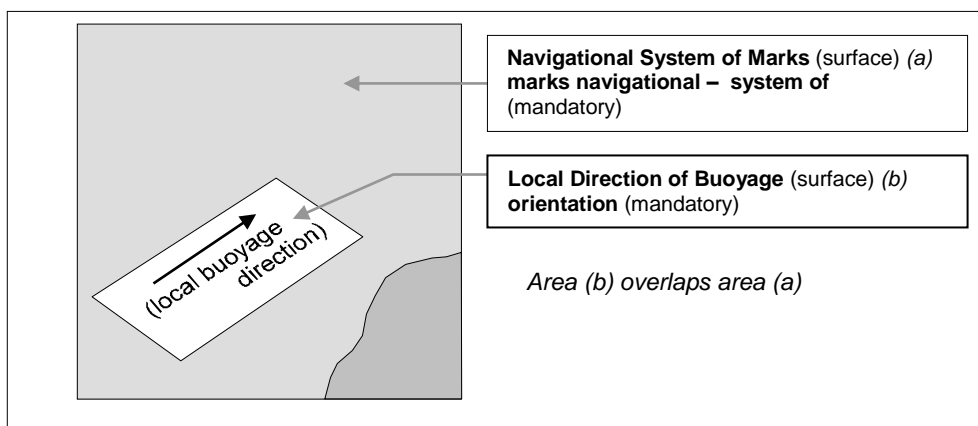

Buoyage system and direction

Individual buoys and beacons may not be part of the general buoyage system. This should be encoded using the attribute **marks navigational – system of** on these buoy and beacon features.

18.3.1.1 Encoding IALA marks within IALA A or B

In the following tables the symbol ‘/’ indicates that this attribute does not exist for that particular feature class. The tables contain the most common examples of encoding; other encoding combinations are possible. For encoding of buoys, substitute **Buoy** for **Beacon** in the Feature column. The table containing encoding combinations for topmarks refers to the sub-attribute values for the complex attribute **topmark**.

Real World Feature	INT 1	Feature	category of cardinal mark	colour	colour pattern	marks navigational – system of
North cardinal beacon	Q 130.3	Beacon Cardinal	1	2,6	1	1 and 2 (IALA A and B)
East cardinal beacon	Q 130.3	Beacon Cardinal	2	2,6,2	1	1 and 2 (IALA A and B)
South cardinal beacon	Q 130.3	Beacon Cardinal	3	6,2	1	1 and 2 (IALA A and B)
West cardinal beacon	Q 130.3	Beacon Cardinal	4	6,2,6	1	1 and 2 (IALA A and B)
Real World Feature	INT 1	Feature	category of lateral mark	colour	colour pattern	marks navigational – system of
Port lateral beacon	Q 130.1	Beacon Lateral	1	3	/	1 (IALA A)
Starboard lateral beacon	Q 130.1	Beacon Lateral	2	4	/	1 (IALA A)
Preferred channel to starboard lateral beacon	Q 130.1	Beacon Lateral	3	3,4,3	1	1 (IALA A)
Preferred channel to port lateral beacon	Q130.1	Beacon Lateral	4	4,3,4	1	1 (IALA A)
Port lateral beacon	Q130.1	Beacon Lateral	1	4	/	2 (IALA B)
Starboard lateral beacon	Q130.1	Beacon Lateral	2	3	/	2 (IALA B)
Preferred channel to starboard lateral beacon	Q130.1	Beacon Lateral	3	4,3,4	1	2 (IALA B)
Preferred channel to port lateral beacon	Q130.1	Beacon, Lateral	4	3,4,3	1	2 (IALA B)

Real World Feature	INT 1	Feature	colour	colour pattern	marks navigational – system of
Isolated danger beacon	Q 130.4	Beacon Isolated Danger	2,3,2	1	1 and 2 (IALA A and B)
Safe water beacon	Q130.5	Beacon Safe Water	3,1 or 1,3	2	1 and 2 (IALA A and B)
Special purpose beacon	Q130.6	Beacon Special Purpose/General	6	/	1 and 2 (IALA A and B)
Emergency wreck marking buoy		Buoy Emergency Wreck Marking	5,6	2	1 or 2 (IALA A or B)

Real World Feature	INT 1	Feature	topmark / daymark shape	colour	colour pattern	marks navigational – system of
North cardinal topmark	Q130.3	Beacon Cardinal	13	2	/	1 and 2 (IALA A and B)

Real World Feature	INT 1	Feature	topmark / daymark shape	colour	colour pattern	marks navigational – system of
East cardinal topmark	Q130.3	Beacon Cardinal	11	2	/	1 and 2 (IALA A and B)
South cardinal topmark	Q130.3	Beacon Cardinal	14	2	/	1 and 2 (IALA A and B)
West cardinal topmark	Q130.3	Beacon Cardinal	10	2	/	1 and 2 (IALA A and B)
Isolated danger topmark	Q130.4	Beacon Isolated Danger	4	2	/	1 and 2 (IALA A and B)
Port lateral topmark	Q130.1	Beacon Lateral	5	3	/	1 (IALA A)
Starboard lateral topmark	Q130.1	Beacon Lateral	1	4	/	1 (IALA A)
Port lateral topmark	Q130.1	Beacon Lateral	5	4	/	2 (IALA B)
Starboard lateral topmark	Q130.1	Beacon Lateral	1	3	/	2 (IALA B)
Safe water topmark	Q130.1	Beacon Safe Water	3	3	2	1 and 2 (IALA A and B)
Special purpose topmark	Q130.1	Beacon Special Purpose/General	7	6	/	1 and 2 (IALA A and B)
Emergency wreck marking topmark		Buoy Emergency Wreck Marking	8	6	/	1 or 2 (IALA A or B)

19 Geo Features – Lights

For the purpose of encoding lights in ENC, the following features must be used, depending on the type of light:

- **Light All Around** (see clause X.X) for lights having the same character over the whole horizon of interest to marine navigation (all-round lights)), excluding fog detector and air obstruction lights;
- **Light Sectored** (see clause X.X) for lights having one or more sectors which have different characteristics, including directional lights and lights having obscured or partially obscured sectors;
- **Light Fog Detector** (see clause X.X) for lights used to automatically determine conditions of visibility which warrant the turning on or off of a sound signal; and
- **Light Air Obstruction** (see clause X.X) for lights marking an obstacle which constitutes a danger to air navigation.

When encoding a light, the combination of the character and purpose of the light must be evaluated in order to determine the most appropriate light feature from the above list.

19.1 Lights: General

19.1.1 Rhythms of lights (see S-4 – B-471.2)

The principal character of a light is its rhythm (although, strictly, fixed lights and some alternating lights are not “rhythmic”).

If it is required to encode the rhythms of lights, this must be done using the complex attribute **rhythm of light**, sub-attributes **light characteristic** and **signal group**. When populating **rhythm of light**, the sub-attributes **signal group**, **signal period** and **signal sequence** are only valid for non-fixed lights (that is, sub-attribute **light characteristic** ≠ 1 (fixed)), with **signal group** and **signal period** being mandatory.

The use of these sub-attributes is defined in the following table; it contains the most common examples of coding; other coding combinations are possible:

Rhythms of lights	F	Oc	Oc(2)	Oc(2+3)	Iso	FI	FI(3)	LFI
light characteristic	1	8	8	8	7	2	2	3
signal group	<i>prohibited</i>	(1)	(2)	(2+3)	(1)	(1)	(3)	(1)

Rhythms of lights	Q	Q(3)	IQ	VQ	VQ(3)	IVQ	UQ	IUQ
light characteristic	4	4	9	5	5	10	6	11
signal group	(1)	(3)	()	(1)	(3)	()	(1)	()

Rhythms of lights	Mo(K)	FFI	Q(6)+LFI	VQ(6)+LFI	AI.WR	AI.FI.WR	AI.FI(2W+1R)	AI.Oc(4)WR
light characteristic	12	13	25	26	28	19	19	17
signal group	(K)	()(1)	(6)(1)	(6)(1)	()	(1)	(2+1)	(4)

Some lights recently constructed may appear to the mariner as “fixed and flashing - FFL” by night, while the real-world feature actually comprises two separate lights vertically disposed, one fixed and the other flashing (F&FI). When it is known that two separate features actually exist, they must be encoded as separate light features, in this case two **Light All Around** features, one with complex attribute **rhythm of light**, sub-attribute **light characteristic** = 1 (fixed) and the other with **light characteristic** = 2 (flashing), and not as one **Light All Around** with **light characteristic** = 13 (fixed/flash).

19.1.2 Types and functions of lights (see S-4 – B-471.1)

If it is required to encode types and functions of lights, this must be done using the attribute **category of light** (see clause X.X).

19.1.3 Elevations of lights (see S-4 – B-471.6)

The elevation of a light is the vertical distance between the light source and the plane of reference for heights for the ENC data (see clause X.X).

If it is required to encode the elevation of a light on a fixed structure, it must be done using the attribute **height**.

If it is required to encode the height above the water surface of a light on a floating structure, it must be done using an associated instance of the information class **Nautical Information** (see clause X.X), complex attribute **information** on the relevant light feature.

19.1.4 Times of exhibition and exhibition conditions (see S-4 – B-473)

[text]

19.1.4.1 Night lights

If it is required to encode a night light, it must be done using the attribute **exhibition condition of light** = 4 (night light) on the light feature.

19.1.4.2 Unwatched lights (see S-4 – B-473.1)

This information should not be encoded, but unwatched (unmanned) lights, with no standby or emergency arrangements, may be encoded using attribute **status** = 17 (unwatched).

19.1.4.3 Occasional lights (see S-4 – B-473.2)

If it is required to encode an occasional light, it must be done using attribute **status** = 2 (occasional). If it is required to encode a private light that is not regularly exhibited, it must be done using **status** = 2,8 (occasional, private).

19.1.4.4 Daytime lights (see S-4 – B-473.4)

If it is required to encode a light shown throughout 24 hours without change of character, it must be done using attribute **exhibition condition of light** = 1 (light shown without change of character).

If it is required to encode a light having characteristics shown by day different from those shown at night, it must be done by encoding two light features sharing the same point spatial instance:

- one light feature with **exhibition condition of light** = 2 (daytime light),
- one light feature with **exhibition condition of light** = 4 (night light).

19.1.4.5 Fog lights (see S-4 – B-473.5)

If it is required to encode a light which is exhibited in fog or conditions of reduced visibility, it must be done using a light feature, with attributes **exhibition condition of light** = 3 (fog light) and **status** = 2 (occasional).

If it is required to encode a light having characteristics shown in fog that are different from those shown in conditions of normal visibility, it must be done by encoding two light features sharing the same point spatial instance:

- one light feature with **exhibition condition of light** = 3 (fog light) and **status** = 2 (occasional)
- one light feature with **exhibition condition of light** = 2 (daytime light) or 4 (night light) and an associated instance of the information class **Nautical Information** (see clause X.X), complex attribute **information**, sub-attribute **text** = *Character of the light changes in fog*.

Note the distinction between fog lights and fog detector lights, which are lights used to automatically determine conditions of visibility which warrant the turning on or off of a sound signal. Fog detector lights must be encoded, where required, using the feature **Light Fog Detector** (see clause X.X).

19.1.5 Leading lights (see S-4 – B-475.6)

If it is required to encode a leading light, it must be done using an appropriate light feature, with attribute:

category of light = 4,12 - front leading light
 4,13 - rear leading light
 4,14 - lower leading light
 4,15 - upper leading light

Remarks:

- Even if, on the source, the leading lights are merged into a single symbol, a light feature must be created for each light. These lights must be placed in their true position; that is, where the source (for example paper chart) shows a single light with a legend such as *2F.Bu*, further investigation

must be done in order to determine the true position of each light, and its full attribution. Compilers should note that where this occurs on paper charts, the position of the light shown on the chart normally corresponds with the rear leading light.

- The leading line must be encoded using the method described in clause X.X.

19.1.6 Lighthouses (see S-4 – B-457.3)

If it is required to encode a lighthouse, it must be done using a **Landmark** feature (see clause X.X), with attributes **category of landmark** = 17 (tower) and **function** = 33 (light support) for towers, or using a **Building** feature (see clause X.X), with the attribute **function** = 33, for any other shapes.

If it is required to encode the attributes **elevation**, **height** and **vertical length** for a lighthouse, this must be done as described in clause X.X.

If the lighthouse is permanently extinguished/unlit, this must be indicated by population of the attribute **status** = 4 (not in use) for the **Landmark/Building**, and the light feature must be removed. Where a lighthouse is illuminated by floodlights, the additional value of **status** = 12 (illuminated) must also be populated. For lights that are temporarily extinguished, see clause X.X.

19.1.7 Various special types of lights

Type	S-4	category of light	Remarks
Subsidiary light	B-471.8	10	Encoded as a separate light from the main light feature
Aero light	B-476.1	5	
Air obstruction light	B-476.2		Encode using feature Light Air Obstruction
Fog detector light	B-477		Encode using feature Light Fog Detector
Bearing light		18	
Flood light	B-478.2	8	Only to encode flood lights that are visible from seaward. The illuminated structure should be encoded using appropriate feature classes, with attribute status = 12 (illuminated)
Synchronised lights	B-478.3		status = 15. Synchronised lights may be associated using the collection feature Association
Strip light	B-478.5	9	
Spot light		11	Only to encode spot lights that are visible from seaward. The illuminated feature should be encoded using appropriate feature classes, with attribute status = 12 (illuminated)
Emergency light		17	Must be encoded as a separate feature to the main light feature
Horizontally disposed lights	B-471.8	19	The number of lights must be encoded using complex attribute multiplicity of features
Vertically disposed lights	B-471.8	20	The number of lights must be encoded using complex attribute multiplicity of features

19.1.8 Light structures

Light features located in the water must have a structure feature, generally a beacon (for example **Beacon Lateral**, **Beacon Special Purpose/General**) or other fixed structure (for example **Offshore Platform**), or a buoy structure (for example **Buoy Lateral**, **Buoy Special Purpose/General**) for

floating aids to navigation. When a light is located in the water with no indication on the source of the structure feature, regardless of the height of the light, a **Pile** feature of type surface or a **Beacon Special Purpose/General** feature should be encoded as the structure feature. This will ensure that a symbol will be shown on ECDIS systems when the light features are not displayed during daytime navigation.

19.2 Light all around

IHO Definition: **LIGHT.** A light is a luminous or lighted aid to navigation. (IHO Dictionary – S-32).

An all around light is a light that is visible over the whole horizon of interest to marine navigation and having no change in the characteristics of the light.

S-101 Geo Feature: Light all around (LIGHTS)

Primitives: Point

Real World

Paper Chart Symbol

ECDIS Symbol

S-101 Attribute	S-57 Acronym	Allowable Encoding Value	Type	Multiplicity
Category of light	(CATLIT)	4 : leading light 5 : aero light 8 : flood light 9 : strip light 10 : subsidiary light 11 : spotlight 12 : front 13 : rear 14 : lower 15 : upper 17 : emergency 18 : bearing light 19 : horizontally disposed 20 : vertically disposed	EN	0,*
Colour	(COLOUR)	1 : white 3 : red 4 : green 5 : blue 6 : yellow 9 : amber 10 : violet 11 : orange	EN	1,* (ordered)
Exhibition condition of light	(EXCLIT)	1 : light shown without change of character 2 : daytime light 3 : fog light 4 : night light	EN	0,1
Feature name			C	0,*
Display name			(S) BO	0,1
Language		ISO 639-3	(S) TE	0,1
Name	(OBJNAM) (NOBJNM)		(S) TE	1,1
Fixed date range			C	0,1
Date end	(DATEND)	ISO 8601: 2004	(S) TD	0,1
Date start	(DATSTA)	ISO 8601: 2004	(S) TD	0,1
Height	(HEIGHT)		RE	0,1
Light visibility	(LITVIS)	1 : high intensity 2 : low intensity	EN	0,1
Major light			BO	0,1

Marks navigational – system of	(MARSYS)	1 : IALA A 2 : IALA B 9 : no system 11 : CEVNI	EN	0,1
Multiplicity of features			C	0,1
Multiplicity known			(S) BO	1,1
Number of features	(MLTYLT)		(S) IN	0,1
Periodic date range			C	0,*
Date end	(PEREND)	ISO 8601: 2004	(S) TD	1,1
Date start	(PERSTA)	ISO 8601: 2004	(S) TD	1,1
Rhythm of light			C	1,1
Light characteristic	(LITCHR)	1 : fixed 2 : flashing 3 : long-flashing 4 : quick-flashing 5 : very quick-flashing 6 : ultra quick-flashing 7 : isophased 8 : occulting 11 : interrupted ultra quick flashing 12 : morse 13 : fixed and flash 14 : flash and long-flash 15 : occulting and flash 16 : fixed and long-flash 17 : occulting alternating 18 : long-flash alternating 19 : flash alternating 25 : quick-flash plus long-flash 26 : very quick-flash plus long flash 27 : ultra quick-flash plus long flash 28 : alternating 29 : fixed and alternating flashing	(S) EN	1,1
Signal group	(SIGGRP)		(S) TE	0,* (ordered)
Signal period	(SIGPER)		(S) RE	0,1
Signal sequence	(SIGSEQ)		(S) C	0,* (ordered)
Signal duration			(S) RE	1,1
Signal status		1 : lit/sound 2 : eclipsed/silent	(S) EN	1,1
Status	(STATUS)	1 : permanent 2 : occasional 4 : not in use 5 : periodic/intermittent 6 : reserved 7 : temporary 8 : private 11 : extinguished 14 : public 15 : synchronized 16 : watched 17 : un-watched	EN	0,*
Value of nominal range	(VALNMR)		RE	0,1

Vertical datum	(VERDAT)	3 : Mean sea level 16 : Mean high water 17 : Mean high water springs 18 : High water 19 : Approximate mean sea level 20 : High water springs 21 : Mean higher high water 24 : Local datum 25 : International great lakes datum 1985 26 : Mean water level 28 : Higher high water large tide 29 : Nearly highest high water 30 : Highest astronomical tide (HAT)	EN	0,1
Scale minimum	(SCAMIN)	See clause X.X	IN	0,1
Flare angle			IN	0,1

INT 1 Reference: P 1-65

19.2.1 All around lights (see S-4 – B-470)

If it is required to encode an all around light (excluding fog detector and air obstruction lights), it must be done using the feature **Light All Around**. This feature must be an equipment feature of a structure feature (see clause X.X), which may be another light feature at the same position (if it exists and there is no structure feature available), using a **Structure/equipment** feature association.

The IALA Maritime Buoyage System rules do not apply for most landfall lights and will apply to minor lights, but not to leading lights, some sector lights or major floating lights. In general, sector lights follow IALA convention when used for marking a channel.

Further guidance for encoding various types and characteristics of lights can be found in clauses X.X to X.X.

Remarks:

- All sector lights, whether single sectored, multi-sectored or having sectors that are deliberately obscured or completely or partially obscured by obstructions, must be encoded, where required, using the feature **Light Sectored** (see clause X.X), unless they are a directional sector or bearing (see clause X.X).
- Fog detector and air obstruction lights must be encoded, where required, using the features **Light Fog Detector** and **Light Air Obstruction** (see clauses X.X and X.X).
- If it is required to encode details of the lighting technology (for example neon), it must be done using an associated instance of the information class **Nautical Information** (see clause X.X), complex attribute **information**.
- If it is required to encode the purpose of a marine spotlight, it must be done using an associated instance of the information class **Nautical Information**, complex attribute **information**.
- Lights on land encoded as major lights (Boolean attribute **major light** = *True*) must have a structure feature encoded (see clause X.X) in order for the position of the light to be clearly indicated in the ECDIS.
- The attribute **vertical datum** applies only to **height**; this value must only be encoded if it is different from the value encoded in the VDAT subfield of the “Coordinate Reference System Header field” [CRSH] field, or different from the value of **vertical datum** encoded on meta feature **Vertical Datum of Data**.
- The indication that a light is a “major” light through the population of the Boolean attribute **major light** with a *True* value determines the way the light is displayed in ECDIS, and is not based on any legal or formal classification of the importance of lights. Generally, a major light may be considered to be a light intended for use at sea, usually with a range of 15 miles or more, and in outer approaches to harbours. However the determination of what is a major light may be based on a number of additional factors, including the number and characteristics of navigational (and non-navigational) lights in the geographical area, and specific navigational requirements for the area. Indication in a dataset that a light is a major light should be based only on the requirements for ECDIS display, at the discretion of the Producing Authority.
- Names of major lights are very important. If a light has a name which is unrelated to any other encoded feature, the name must be populated using the complex attribute **feature name** on at least the largest maximum display scale ENC data. If the name of a light is obviously that of the named feature on which the

light stands, for example Saint Catherine's Point, the name of the light need not be repeated for the light.

Distinction: Beacon cardinal; beacon isolated danger; beacon lateral; beacon safe water; beacon special purpose/general; buoy cardinal; buoy installation; buoy isolated danger; buoy lateral; buoy safe water; buoy special purpose/general; light air obstruction; light directional; light float; light fog detector; light sector; light vessel.

Feature/Information associations							
Type	Association Name	Association Ends					
		Class	Role	Mult	Class	Role	Mult
Comp	Structure/Equipment	Light All Around	Supports	1,*	Beacon Cardinal, Beacon Isolated Danger, Beacon Lateral, Beacon Safe Water, Beacon Special Purpose/General, Bridge, Building, Buoy Cardinal, Buoy Emergency Wreck Marking, Buoy Installation, Buoy Isolated Danger, Buoy Lateral, Buoy Safe Water, Buoy Special Purpose/General, Crane, Conveyor, Daymark, Fishing Facility, Floating Dock, Fortified Structure, Hulk, Landmark, Light All Around, Light Float, Light Vessel, Mooring/Warping Facility, Offshore Platform, Pile, Pipeline Overhead, Pontoon, Pylon/Bridge Support, Shoreline Construction, Silo/Tank, Span Fixed, Span Opening, Wind Turbine	Supported by	0,1
Aggr	Range System Aggregation	Light All Around	Consists of	1,*	Range System	Component of	0,1
Aggr	Traffic Separation Scheme Aggregation	Light All Around	Consists of	1,*	Traffic Separation Scheme	Component of	0,1
Asso	Aids to Navigation Association	Light All Around	Consists of	1,*	Archipelagic Sea Lane, Bridge Deep Water Route, Fairway System, Traffic Separation Scheme, Two-Way Route	Component of	0,1

19.3 Light sectored

IHO Definition: **LIGHT.** A light is a luminous or lighted aid to navigation. (IHO Dictionary – S-32).

A sectored light is a light having one or more sectors, which have different characteristics across, and sometimes within, each sector.

S-101 Geo Feature: Light sectored (LIGHTS)

Primitives: Point

Real World

Paper Chart Symbol

ECDIS Symbol

S-101 Attribute	S-57 Acronym	Allowable Encoding Value	Type	Multiplicity
Category of light	(CATLIT)	4 : leading light 5 : aero light 8 : flood light 9 : strip light 10 : subsidiary light 11 : spotlight 12 : front 13 : rear 14 : lower 15 : upper 17 : emergency 18 : bearing light 19 : horizontally disposed 20 : vertically disposed	EN	0,*
Exhibition condition of light	(EXCLIT)	1 : light shown without change of character 2 : daytime light 4 : night light	EN	0,1
Feature name			C	0,*
Display name			(S) BO	0,1
Language		ISO 639-3	(S) TE	0,1
Name	(OBJNAM) (NOBJNM)		(S) TE	1,1
Fixed date range			C	0,1
Date end	(DATEND)	ISO 8601: 2004	(S) TD	0,1
Date start	(DATSTA)	ISO 8601: 2004	(S) TD	0,1
Height	(HEIGHT)		RE	0,1
Marks navigational – system of	(MARSYS)	1 : IALA A 2 : IALA B 9 : no system 11 : CEVNI	EN	0,1
Periodic date range			C	0,*
Date end	(PEREND)	ISO 8601: 2004	(S) TD	1,1
Date start	(PERSTA)	ISO 8601: 2004	(S) TD	1,1
Sector characteristics			C	1,*
Light characteristic	(LITCHR)	1 : fixed 2 : flashing	(S) EN	1,1

		3 : long-flashing 4 : quick-flashing 5 : very quick-flashing 6 : ultra quick-flashing 7 : isophased 8 : occulting 11 : interrupted ultra quick flashing 12 : morse 13 : fixed and flash 14 : flash and long-flash 15 : occulting and flash 16 : fixed and long-flash 17 : occulting alternating 18 : long-flash alternating 19 : flash alternating 25 : quick-flash plus long-flash 26 : very quick-flash plus long flash 27 : ultra quick-flash plus long flash 28 : alternating 29 : fixed and alternating flashing		
Light sector			(S) C	1,*
Colour	(COLOUR)	1 : white 3 : red 4 : green 5 : blue 6 : yellow 9 : amber 10 : violet 11 : orange	(S) EN	1,* (ordered)
Directional character			(S) C	0,1
Moiré effect			(S) BO	0,1
Orientation			(S) C	1,1
Orientation uncertainty			(S) RE	0,1
Orientation value	(ORIENT)		(S) RE	1,1
Light visibility	(LITVIS)	1 : high intensity 2 : low intensity 3 : faint 4 : intensified 5 : unintensified 6 : visibility deliberately restricted 8 : partially obscured 9 : visible in line of range	(S) EN	0,*
Sector limit			(S) C	0,1
Sector limit one	(SECTR1)		(S) C	1,1
Sector bearing			(S) RE	1,1
Sector line length			(S) IN	0,1
Sector limit two	(SECTR2)		(S) C	1,1
Sector bearing			(S) RE	1,1
Sector line length			(S) IN	0,1
Value of nominal range	(VALNMR)		(S) RE	0,1

Sector information			(S) C	0,*
Language		ISO 639-3	(S) TE	0,1
Text	(INFORM) (NINFOM)		(S) TE	1,1
Sector extension			(S) IN	0,1
Signal group	(SIGGRP)		(S) TE	0,* (ordered)
Signal period	(SIGPER)		(S) RE	0,1
Signal sequence	(SIGSEQ)		(S) C	0,* (ordered)
Signal duration			(S) RE	1,1
Signal status		1 : lit/sound 2 : eclipsed/silent	(S) EN	1,1
Status	(STATUS)	1 : permanent 2 : occasional 4 : not in use 5 : periodic/intermittent 6 : reserved 7 : temporary 8 : private 11 : extinguished 14 : public 15 : synchronized 16 : watched 17 : un-watched	EN	0,*
Vertical datum	(VERDAT)	3 : Mean sea level 16 : Mean high water 17 : Mean high water springs 18 : High water 19 : Approximate mean sea level 20 : High water springs 21 : Mean higher high water 24 : Local datum 25 : International great lakes datum 1985 26 : Mean water level 28 : Higher high water large tide 29 : Nearly highest high water 30 : Highest astronomical tide (HAT)	EN	0,1
Scale minimum	(SCAMIN)	See clause X.X	IN	0,1

INT 1 Reference: P 1-65

19.3.1 Sectored lights (see S-4 – B-475)

If it is required to encode a light that consists of one or more sectors, it must be done using the feature **Light Sectored**. This feature must be an equipment feature of a structure feature (see clause X.X), which may be another light feature at the same position (if it exists and there is no structure feature available), using a **Structure/equipment** feature association.

The IALA Maritime Buoyage System rules do not apply for most landfall lights and will apply to minor lights, but not to leading lights, some sector lights or major floating lights. In general, sector lights follow IALA convention when used for marking a channel.

Further guidance for encoding various types and characteristics of lights can be found in clauses X.X to X.X.

Remarks:

- The complex attribute **sector characteristics**, sub-complex attribute **light sector** is used to populate each

sector for the light, except for sectors in which there is no light exhibited. Where there is a different rhythm of light between sectors (for example, for complex lights), separate instances of **sector characteristics** must be populated.

- Population of the sub-complex attribute **sector limit** having sub-complex attributes **sector limit one (sector angle) = 0** and **sector limit two (sector angle) = 360** (that is, encoding an all around light as a sectored light) is prohibited.
- If a sector of sectored light is intended to have a directional function, this must be encoded using the **light sector** complex sub-attributes **directional character**. If the light is intensified in this sector, **light sector** sub-attribute **light visibility = 4** (intensified) must be populated. The sub-complex attribute **sector limit** is optional for directional light sectors.
- If a sector of a sectored light is not directional the **sector characteristics** complex sub-complex attribute **sector limit** is mandatory, and the sub-attribute **directional character** must not be populated for the light sector.
- Sector limits should cover the area where they are useful to mariners. Where it is required to restrict the length of a sector limit to only the area that is useful to the mariner so as to avoid ECDIS screen clutter, this must be done using the sub-attribute **sector line length** within the complex attribute **sector limit**.
- The fairway defined by the succession of navigable areas in the white sectors of a series of **Light Sectored** features may be encoded using the feature **Fairway** (see clause X.X).
- If there is additional information required to be encoded that is relevant to all sectors of the light, this must be done using an associated instance of the information class **Nautical Information** (see clause X.X). If the additional information is relevant to individual sectors of the light only (for example, for complex (oscillating) light sectors (see clause X.X.X.X below)), this must be encoded using the complex sub-attribute **sector information** for the sub-complex attribute **light sector**.
- If it is required to encode details of the lighting technology (for example neon), it must be done using an associated instance of the information class **Nautical Information**, complex attribute **information**.
- The attribute **vertical datum** applies only to **height**; this value must only be encoded if it is different from the value encoded in the VDAT subfield of the “Coordinate Reference System Header field” [CRSH] field, or different from the value of **vertical datum** encoded on meta feature **Vertical Datum of Data**.
- Names of major lights are very important. If a light has a name which is unrelated to any other encoded feature, the name must be populated using the complex attribute **feature name** on at least the largest scale maximum display scale ENC data. If the name of a light is obviously that of the named feature on which the light stands, for example Saint Catherine’s Point, the name of the light need not be repeated for the light.

19.3.1.1 Lights obscured by obstructions (see S-4 – B-475.3)

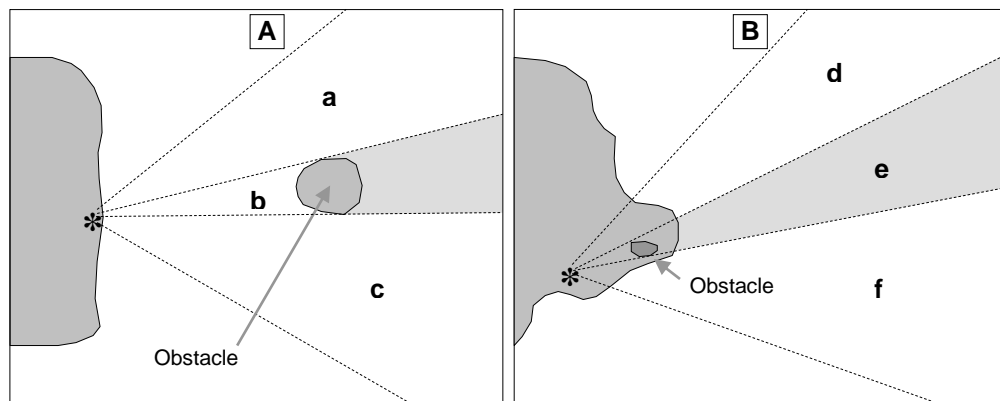

If an encoded light is obscured in a part of the navigable area of a sector (see Figure A above) beyond an offshore obstruction, it must be encoded using **Light Sectored**, with each of the sectors (a) – (c) encoded using the complex attribute **light sector**. The partially obscured sector of (b) must have **light sector** with sub-attributes **light visibility = 8** (partially obscured) and sub-attribute **value of nominal range** set to the distance from the light to the obstruction. The sectors in which the light is visible from seaward ((a) and (c)) must be encoded as separate iterations of **light sector**.

If there is no navigable water between the light and the obstruction (see (e) in Figure B above), the masked sector must not have an iteration of **light sector** encoded, unless a faint light is visible in the navigable part of the sector, which should be encoded using **light sector**, with sub-attribute **light visibility = 3** (faint). The sectors in which the light is visible from seaward ((d) and (f)) must be encoded as separate iterations of **sector**

characteristics.**19.3.1.2 Directional lights (see S-4 – B-475.7-8)**

Directional (or direction) lights of several types are in use but all have in common a very narrow sector intended to mark a direction to be followed. The narrow sector may be flanked by:

- Unlit sectors or unintensified light.
- Sectors of different colour or character. Some direction lights are so precise that a complete colour change at a sector boundary occurs over an angle of less than 1 minute (0.02°). This corresponds to a lateral distance of just 1 metre at a viewing distance of 3.5 km. In addition the intensity may be maintained right to the edge of the beam, and does not reduce the further the observer is away from the axis.

A moiré effect mark (or variable arrow mark) is a short-range (normally up to 2 km) type of directional “light”. Sodium lighting gives a yellow background to a screen (up to 3 m square) on which a vertical black line will be seen by an observer on the centreline, or variable arrow marks when course alteration is needed. The system can be used by day and night. It can also be used as a stop line (seen abeam) for vessels berthing along quays.

If it is required to encode a light sector having a directional function, it must be done using the feature **Light Sector**.

Remarks:

- The indication that a particular light sector has a directional function is encoded by populating the complex attribute **sector characteristics**, sub-complex attribute **directional character**.
- The mandatory complex sub-attribute **orientation** must only be encoded to indicate the orientation, measured from seaward, of the leading line of the directional light sector when there is no **Recommended Track** or **Navigation Line** feature associated with the directional light. Where the directional sector has an associated **Recommended Track** and/or **Navigation Line**, **orientation (orientation value)** for the light sector must be populated with an empty (null) value.
- For a sector indicated as directional, the **light sector** complex sub-complex attribute **sector limit** is optional.
- For moiré effect lights, the Boolean sub-attribute **moiré effect** must be set to *True*.
- If it is required to encode the recommended track and/or navigation line associated with a directional light, it must be done using the methods described in clause X.X.

19.3.1.3 Oscillating light sectors

Evolving technology in the development of navigational lights has resulted in the installation of complex directional navigation lights with multiple sectors, colours and characteristics, some with oscillating sectors, in many areas where navigation is restricted. These lights may have up to 7 sectors, with the central sector being a very narrow, sometimes intensified, fixed white sector performing the directional function of the light. In the IALA A System, the sectors flanking this directional light may be alternating and oscillate increasingly from white to green (to starboard) and red (to port) with increasing deviation from the track defined by the directional light. These lights will normally be flanked by narrow sectors of fixed green (to starboard) and red (to port). Additionally, there may be outer sectors that are occulting green (to starboard) and red (to port) which oscillate with increasing period of eclipse to isophased or flashing with increasing deviation from the track defined by the directional light. For the IALA B System the colours are reversed. In some cases these complex lights may not conform to IALA. Each of the outer sectors may be very narrow.

If is required to encode an oscillating light sector, it should be done using a **Light Sector** feature, with iterations of the complex attribute **sector characteristics** as follows:

For light sectors in the IALA A system that are alternating and oscillate increasingly from white to green (to starboard) and red (to port) with increasing deviation from the track defined by the directional light:

sector characteristics: light characteristic = 28 (Alternating); **colour** = 1,3 (White, Red); **sector limit;**
sector information (text) = *White phase decreases as bearing to light increases*

sector characteristics: light characteristic = 28 (Alternating); **colour** = 1,4 (White, Green); **sector limit;**
sector information (text) = *White phase increases as bearing to light increases*

For lights in the IALA B system that are alternating and oscillate increasingly from white to red (to starboard) and green (to port) with increasing deviation from the track defined by the directional light; transpose the colours red and green in the above encoding.

For lights in the IALA A system that are occulting green (to starboard) and red (to port) which oscillate with increasing period of eclipse to isophased or flashing with increasing deviation from the track defined by the

directional light:

sector characteristics: **light characteristic** = 8 (Occulting); **colour** = 3 (Red); **sector limit;** **sector information (text)** = *Light phase decreases as bearing to light increases*

sector characteristics: **light characteristic** = 8 (Occulting); **colour** = 4 (Green); **sector limit;** **sector information (text)** = *Light phase increases as bearing to light increases*

For lights in the IALA B system that are occulting red (to starboard) and green (to port) which oscillate with increasing period of eclipse to isophased or flashing with increasing deviation from the track defined by the directional light; transpose the colours red and green in the above encoding.

Oscillating lights which are not IALA should be encoded similar to the above. For instance, where a light contains white sectors that are occulting and oscillate with increasing period of eclipse to isophased or flashing with increasing deviation from the track defined by the directional light:

For the sector to port of the track defined by the directional light:

sector characteristics: **light characteristic** = 8 (Occulting); **colour** = 1 (White); **sector limit;** **sector information (text)** = *Light phase decreases as bearing to light increases*

For the sector to starboard of the track defined by the directional light:

sector characteristics: **light characteristic** = 8 (Occulting); **colour** = 1 (White); **sector limit;** **sector information (text)** = *Light phase increases as bearing to light increases*

All other light sectors must be encoded using additional iterations of **sector characteristics**, with sub-attributes (including **light sector** or **directional character**) populated in accordance with the characteristics of the sector.

Distinction: Beacon cardinal; beacon isolated danger; beacon lateral; beacon safe water; beacon special purpose/general; buoy cardinal; buoy installation; buoy isolated danger; buoy lateral; buoy safe water; buoy special purpose/general; light air obstruction; light all around; light float; light fog detector; light vessel.

Feature/Information associations

Type	Association Name	Association Ends					
		Class	Role	Mult	Class	Role	Mult
Comp	Structure/Equipment	Light Sector	Supports	1,*	Beacon Cardinal, Beacon Isolated Danger, Beacon Lateral, Beacon Safe Water, Beacon Special Purpose/General, Bridge, Building, Buoy Cardinal, Buoy Emergency Wreck Marking, Buoy Installation, Buoy Isolated Danger, Buoy Lateral, Buoy Safe Water, Buoy Special Purpose/General, Crane, Conveyor, Daymark, Fishing Facility, Floating Dock, Fortified Structure, Hulk, Landmark, Light All Around, Light Sector, Light Float, Light Vessel, Mooring/Warping Facility, Offshore Platform, Pile, Pipeline Overhead, Pontoon,	Supported by	0,1

					Pylon/Bridge Support, Shoreline Construction, Silo/Tank, Span Fixed, Span Opening, Wind Turbine		
Aggr	Range System Aggregation	Light Sector	Consists of	1,*	Range System	Component of	0,1
Aggr	Traffic Separation Scheme Aggregation	Light Sector	Consists of	1,*	Traffic Separation Scheme	Component of	0,1
Asso	Aids to Navigation Association	Light Sector	Consists of	1,*	Archipelagic Sea Lane, Bridge Deep Water Route, Fairway System, Traffic Separation Scheme, Two-Way Route	Component of	0,1

19.4 Light fog detector

IHO Definition: **FOG DETECTOR LIGHT.** A light is a luminous or lighted aid to navigation. (IHO Dictionary – S-32).

A fog detector light is a light used to automatically determine conditions of visibility which warrant the turning on or off of a sound signal. (IHO Dictionary – S-32).

S-101 Geo Feature: Light fog detector (**LIGHTS**)

Primitives: Point

<i>Real World</i>		<i>Paper Chart Symbol</i>		<i>ECDIS Symbol</i>	
S-101 Attribute	S-57 Acronym	Allowable Encoding Value	Type	Multiplicity	
Colour	(COLOUR)	1 : white 3 : red 4 : green 5 : blue 6 : yellow 9 : amber 10 : violet 11 : orange	EN	0,*	
Feature name			C	0,*	
Display name			(S) BO	0,1	
Language		ISO 639-3	(S) TE	0,1	
Name	(OBJNAM) (NOBJNM)		(S) TE	1,1	
Fixed date range			C	0,1	
Date end	(DATEND)	ISO 8601: 2004	(S) TD	0,1	
Date start	(DATSTA)	ISO 8601: 2004	(S) TD	0,1	
Height	(HEIGHT)		RE	0,1	
Periodic date range			C	0,*	
Date end	(PEREND)	ISO 8601: 2004	(S) TD	1,1	
Date start	(PERSTA)	ISO 8601: 2004	(S) TD	1,1	
Rhythm of light			C	0,1	
Light characteristic	(LITCHR)	1 : fixed 2 : flashing 3 : long-flashing 4 : quick-flashing 5 : very quick-flashing 6 : ultra quick-flashing 7 : isophased 8 : occulting 11 : interrupted ultra quick flashing 12 : morse 13 : fixed and flash 14 : flash and long-flash 15 : occulting and flash 16 : fixed and long-flash 17 : occulting alternating	(S) EN	1,1	

		18 : long-flash alternating 19 : flash alternating 25 : quick-flash plus long-flash 26 : very quick-flash plus long flash 27 : ultra quick-flash plus long flash 28 : alternating 29 : fixed and alternating flashing		
Signal group	(SIGGRP)		(S) TE	0,* (ordered)
Signal period	(SIGPER)		(S) RE	0,1
Signal sequence	(SIGSEQ)		(S) C	0,* (ordered)
Signal duration			(S) RE	1,1
Signal status		1 : lit/sound 2 : eclipsed/silent	(S) EN	1,1
Status	(STATUS)	1 : permanent 2 : occasional 4 : not in use 5 : periodic/intermittent 6 : reserved 7 : temporary 8 : private 11 : extinguished 14 : public 15 : synchronized 16 : watched 17 : un-watched	EN	0,*
Vertical datum	(VERDAT)	3 : Mean sea level 16 : Mean high water 17 : Mean high water springs 18 : High water 19 : Approximate mean sea level 20 : High water springs 21 : Mean higher high water 24 : Local datum 25 : International great lakes datum 1985 26 : Mean water level 28 : Higher high water large tide 29 : Nearly highest high water 30 : Highest astronomical tide (HAT)	EN	0,1
Scale minimum	(SCAMIN)	See clause X.X	IN	0,1
Flare angle			IN	0,1

INT 1 Reference: P 62

19.4.1 Fog detector lights (see S-4 – B-477)

If it is required to encode a light used to automatically determine conditions of visibility which warrant the turning on or off of a sound signal, it must be done using the feature **Light Fog Detector**. This feature must be an equipment feature of a structure feature (see clause X.X), if it exists, using a **Structure/equipment** feature association.

Further guidance for encoding various types and characteristics of lights can be found in clauses X.X to X.X.

Remarks:

- If it is required to encode details of the lighting technology (for instance neon), it must be done using an associated instance of the information class **Nautical Information** (see clause X.X), complex attribute **information**.
- The attribute **vertical datum** applies only to **height**; this value must only be encoded if it is different from the value encoded in the VDAT subfield of the “Coordinate Reference System Header” [CRSH] field, or different from the value of **vertical datum** encoded on meta feature **Vertical Datum of Data**.

Distinction: Beacon cardinal; beacon isolated danger; beacon lateral; beacon safe water; beacon special purpose/general; buoy cardinal; buoy installation; buoy isolated danger; buoy lateral; buoy safe water; buoy special purpose/general; light air obstruction; light all around; light float; light sectored; light vessel.

Feature/Information associations							
Type	Association Name	Association Ends					
		Class	Role	Mult	Class	Role	Mult
Comp	Structure/Equipment	Light Fog Detector	Supports	1,*	Beacon Cardinal, Beacon Isolated Danger, Beacon Lateral, Beacon Safe Water, Beacon Special Purpose/General, Bridge, Building, Buoy Cardinal, Buoy Emergency Wreck Marking, Buoy Installation, Buoy Isolated Danger, Buoy Lateral, Buoy Safe Water, Buoy Special Purpose/General, Crane, Conveyor, Daymark, Fishing Facility, Floating Dock, Fortified Structure, Hulk, Landmark, Light Float, Light Vessel, Mooring/Warping Facility, Offshore Platform, Pile, Pipeline Overhead, Pontoon, Pylon/Bridge Support, Shoreline Construction, Silo/Tank, Span Fixed, Span Opening, Wind Turbine	Supported by	0,1

19.5 Light air obstruction

IHO Definition: AIR OBSTRUCTION LIGHT. A light is a luminous or lighted aid to navigation. (IHO Dictionary – S-32).

An air obstruction light is a light marking an obstacle which constitutes a danger to air navigation. (IHO Dictionary – S-32).

S-101 Geo Feature: Light air obstruction (LIGHTS)

Primitives: Point

<i>Real World</i>	<i>Paper Chart Symbol</i>	<i>ECDIS Symbol</i>
-------------------	---------------------------	---------------------

S-101 Attribute	S-57 Acronym	Allowable Encoding Value	Type	Multiplicity
Colour	(COLOUR)	1 : white 3 : red 4 : green 5 : blue 6 : yellow 9 : amber 10 : violet 11 : orange	EN	0,*
Exhibition condition of light	(EXCLIT)	1 : light shown without change of character 2 : daytime light 3 : fog light 4 : night light	EN	0,1
Feature name			C	0,*
Display name			(S) BO	0,1
Language		ISO 639-3	(S) TE	0,1
Name	(OBJNAM) (NOBJNM)		(S) TE	1,1
Fixed date range			C	0,1
Date end	(DATEND)	ISO 8601: 2004	(S) TD	0,1
Date start	(DATSTA)	ISO 8601: 2004	(S) TD	0,1
Height	(HEIGHT)		RE	0,1
Light visibility	(LITVIS)	1 : high intensity 2 : low intensity 3 : faint 4 : intensified 5 : unintensified 6 : visibility deliberately restricted 7 : obscured 8 : partially obscured 9 : visible in line of range	EN	0,*
Multiplicity of features			C	0,1
Multiplicity known			(S) BO	1,1
Number of features	(MLTYLT)		(S) IN	0,1
Periodic date range			C	0,*

Date end	(PEREND)	ISO 8601: 2004	(S) TD	1,1
Date start	(PERSTA)	ISO 8601: 2004	(S) TD	1,1
Rhythm of light			C	0,1
Light characteristic	(LITCHR)	1 : fixed 2 : flashing 3 : long-flashing 4 : quick-flashing 5 : very quick-flashing 6 : ultra quick-flashing 7 : isophased 8 : occulting 11 : interrupted ultra quick flashing 12 : morse 13 : fixed and flash 14 : flash and long-flash 15 : occulting and flash 16 : fixed and long-flash 17 : occulting alternating 18 : long-flash alternating 19 : flash alternating 25 : quick-flash plus long-flash 26 : very quick-flash plus long flash 27 : ultra quick-flash plus long flash 28 : alternating 29 : fixed and alternating flashing	(S) EN	1,1
Signal group	(SIGGRP)		(S) TE	0,* (ordered)
Signal period	(SIGPER)		(S) RE	0,1
Signal sequence	(SIGSEQ)		(S) C	0,* (ordered)
Signal duration			(S) RE	1,1
Signal status		1 : lit/sound 2 : eclipsed/silent	(S) EN	1,1
Status	(STATUS)	1 : permanent 2 : occasional 4 : not in use 5 : periodic/intermittent 6 : reserved 7 : temporary 8 : private 11 : extinguished 14 : public 15 : synchronized 16 : watched 17 : un-watched	EN	0,*
Value of nominal range	(VALNMR)		RE	0,1
Vertical datum	(VERDAT)	3 : Mean sea level 16 : Mean high water 17 : Mean high water springs 18 : High water 19 : Approximate mean sea level 20 : High water springs 21 : Mean higher high water 24 : Local datum 25 : International great lakes datum 1985	EN	0,1

		26 : Mean water level 28 : Higher high water large tide 29 : Nearly highest high water 30 : Highest astronomical tide (HAT)		
Scale minimum	(SCAMIN)	See clause X.X	IN	0,1
Flare angle			IN	0,1

INT 1 Reference: P 61.2

19.5.1 Air obstruction lights (see S-4 – B-476.2)

If it is required to encode a light marking an obstacle which constitutes a danger to air navigation, which may also be used as a marine navigational aid, it must be done using the feature **Light Air Obstruction**. This feature must be an equipment feature of a structure feature (see clause X.X), if it exists, using a **Structure/equipment** feature association.

Further guidance for encoding various types and characteristics of lights can be found in clauses X.X to X.X.

Remarks:

- If it is required to encode details of the lighting technology (for example neon), it must be done using an associated instance of the information class **Nautical Information** (see clause X.X), complex attribute **information**.
- The attribute **vertical datum** applies only to **height**; this value must only be encoded if it is different from the value encoded in the VDAT subfield of the “Coordinate Reference System Header field” [CRSH] field, or different from the value of **vertical datum** encoded on meta feature **Vertical Datum of Data**.

Distinction: Beacon cardinal; beacon isolated danger; beacon lateral; beacon safe water; beacon special purpose/general; buoy cardinal; buoy installation; buoy isolated danger; buoy lateral; buoy safe water; buoy special purpose/general; light all around; light float; light fog detector; light sector; light vessel.

Feature/Information associations							
Type	Association Name	Association Ends					
		Class	Role	Mult	Class	Role	Mult
Comp	Structure/Equipment	Light Air Obstruction	Supports	1,*	Bridge, Building, Crane, Conveyor, Landmark, Offshore Platform, Pylon/Bridge Support, Span Fixed, Span Opening, Wind Turbine	Supported by	0,1

20 Geo Features – Buoys, Beacons

20.1 Lateral buoys

<p>IHO Definition: BUOY, LATERAL. A buoy is a floating object moored to the bottom in a particular place, as an aid to navigation or for other specific purposes. (IHO Dictionary – S-32).</p> <p>A lateral buoy is used to indicate the port or starboard hand side of the route to be followed. They are generally used for well-defined channels and are used in conjunction with a conventional direction of buoyage. (UKHO NP 735, 5th Edition).</p>					
<p>S-101 Geo Feature: Buoy lateral (BOYLAT)</p>					
<p>Primitives: Point</p>					
<p><i>Real World</i></p>		<p><i>Paper Chart Symbol</i></p>		<p><i>ECDIS Symbol</i></p>	
<p>S-101 Attribute</p>		<p>S-57 Acronym</p>	<p>Allowable Encoding Value</p>	<p>Type</p>	<p>Multiplicity</p>
<p>Buoy shape</p>		<p>(BOYSHP)</p>	<p>1 : conical (nun, ogival) 2 : can (cylindrical) 3 : spherical 4 : pillar 5 : spar (spindle) 6 : barrel (tun) 7 : superbuoy 8 : ice buoy</p>	<p>EN</p>	<p>1,1</p>
<p>Category of lateral mark</p>		<p>(CATLAM)</p>	<p>1 : port-hand lateral mark 2 : starboard-hand lateral mark 3 : preferred channel to starboard lateral mark 4 : preferred channel to port lateral mark</p>	<p>EN</p>	<p>1,1</p>
<p>Colour</p>		<p>(COLOUR)</p>	<p>1 : white 2 : black 3 : red 4 : green 5 : blue 6 : yellow 7 : grey 8 : brown 9 : amber 10 : violet 11 : orange 12 : magenta 13 : pink</p>	<p>EN</p>	<p>1,* (ordered)</p>
<p>Colour pattern</p>		<p>(COLPAT)</p>	<p>1 : horizontal stripes 2 : vertical stripes 3 : diagonal stripes 4 : squared 5 : stripes (direction unknown) 6 : border stripe</p>	<p>EN</p>	<p>0,1</p>
<p>Feature name</p>				<p>C</p>	<p>0,*</p>
<p>Display name</p>				<p>(S) BO</p>	<p>0,1</p>

Language		ISO 639-3	(S) TE	0,1
Name	(<i>OBJNAM</i>) (<i>NOBJNM</i>)		(S) TE	1,1
Fixed date range			C	0,1
Date end	(DATEND)	ISO 8601: 2004	(S) TD	0,1
Date start	(DATSTA)	ISO 8601: 2004	(S) TD	0,1
Marks navigational – system of	(MARSYS)	1 : IALA A 2 : IALA B 9 : no system 11 : CEVNI	EN	0,1
Nature of construction	(NATCON)	6 : wooden 7 : metal 8 : glass reinforced plastic (GRP) 11 : latticed	EN	0,*
Periodic date range			C	0,*
Date end	(<i>PEREND</i>)	ISO 8601: 2004	(S) TD	1,1
Date start	(<i>PERSTA</i>)	ISO 8601: 2004	(S) TD	1,1
Radar conspicuous	(CONRAD)		BO	0,1
Status	(STATUS)	1 : permanent 2 : occasional 5 : periodic/intermittent 7 : temporary 8 : private 18 : existence doubtful	EN	0,*
Topmark	(<i>TOPMAR</i>)		C	0,1
Colour	(COLOUR)	1 : white 2 : black 3 : red 4 : green 5 : blue 6 : yellow 7 : grey 8 : brown 9 : amber 10 : violet 11 : orange 12 : magenta 13 : pink	(S) EN	0,1
Topmark/daymark shape	(TOPSHP)	1 : cone, point up 2 : cone, point down 3 : sphere 4 : 2 spheres 5 : cylinder (can) 6 : board 7 : x-shape (St. Andrew's cross) 8 : upright cross (St George's cross) 9 : cube, point up 10 : 2 cones, point to point 11 : 2 cones, base to base 12 : rhombus (diamond) 13 : 2 cones (points upward) 14 : 2 cones (points downward) 15 : besom, point up (broom or perch)	(S) EN	1,1

		16 : besom, point down (broom or perch) 17 : flag 18 : sphere over rhombus 19 : square 20 : rectangle, horizontal 21 : rectangle, vertical 22 : trapezium, up 23 : trapezium, down 24 : triangle, point up 25 : triangle, point down 26 : circle 27 : two upright crosses (one over the other) 28 : T-shape 29 : triangle pointing up over a circle 30 : upright cross over a circle 31 : rhombus over a circle 32 : circle over a triangle pointing up 33 : other shape (see shape information)		
Shape information			(S) C	0,*
Language		ISO 639-3	(S) TE	0,1
Text	(INFORM) (NINFOM)		(S) TE	1,1
Vertical length	(VERLEN)		RE	0,1
Scale minimum	(SCAMIN)	See clause X.X	IN	0,1

INT 1 Reference: Q 130.1

20.1.1 Lateral buoys (see S-4 – B-461.3 and B-467)

Lateral buoys are generally used for well-defined channels, in conjunction with a direction of buoyage. They indicate the port and starboard sides of the route to be followed.

To conform to the IALA Maritime Buoyage System (see clause X.X), port hand buoys are usually can shaped, but may be another shape (except conical or spherical). Other shaped buoys have a can topmark. The colour of port hand buoys, topmarks and lights (if fitted) will be red in IALA region A and green in IALA region B.

To conform to the IALA Maritime Buoyage System, starboard hand buoys are usually conical shaped, but may be another shape (except can or spherical). Other shaped buoys have a conical topmark. The colour of starboard hand buoys, topmarks and lights (if fitted) will be green in IALA region A and red in IALA region B.

A preferred channel mark is a modified lateral mark, with horizontal colour bands. The shape and predominant colour indicates which side is the preferred channel, the other colour indicates the secondary channel. If fitted, the light is Fl(2+1), the colour indicating the preferred channel.

If it is required to encode a buoy having the function of a lateral mark, it must be done using the feature **Buoy Lateral**.

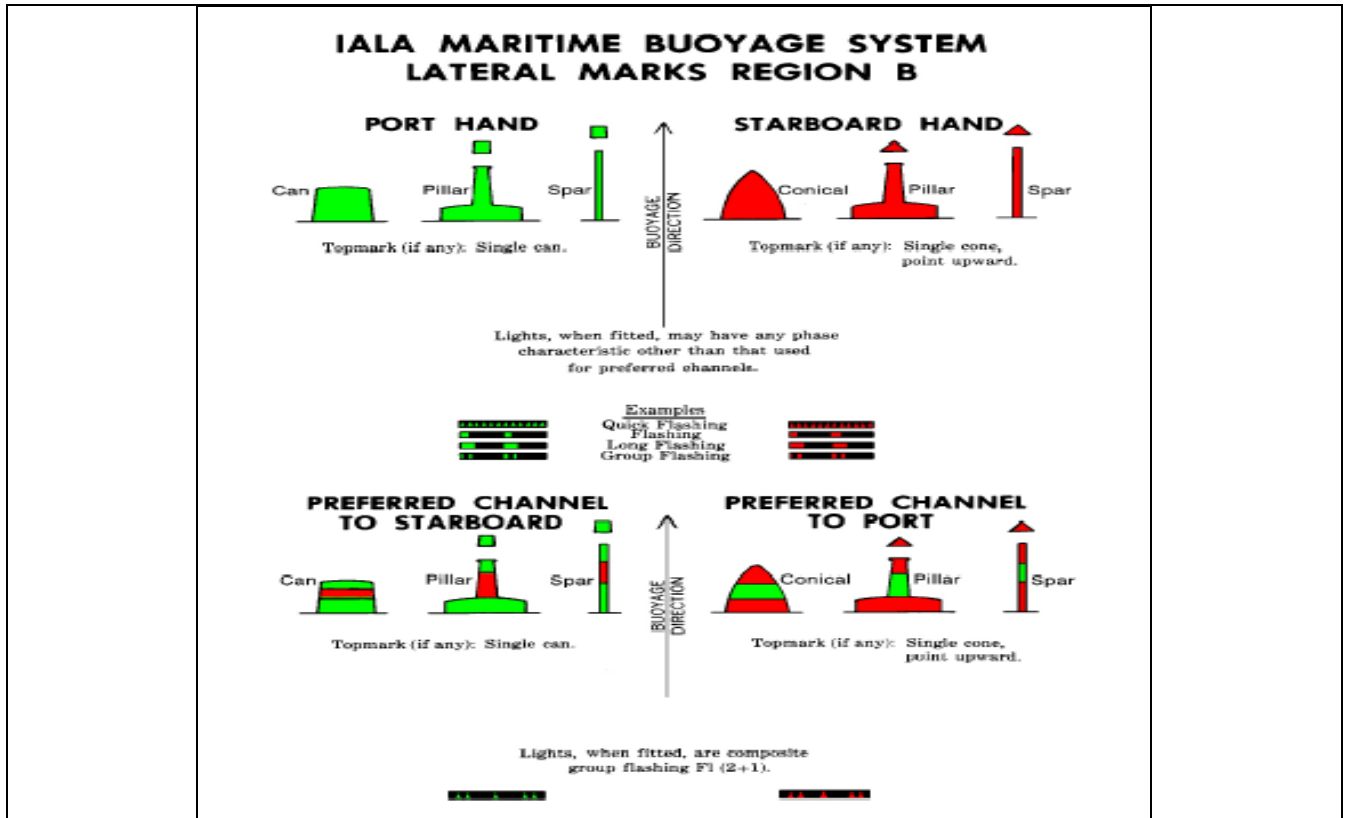

Remarks:

- If it is required to encode a buoy that has more than one colour, the attributes **colour** and **colour pattern** must be encoded, according to the rules laid out in clause X.X.
- If it is required to encode the total vertical length, including the topmark and any equipment features (for example light), of the buoy above the water level, it must be done using the attribute **vertical length**.

Distinction: Buoy cardinal; buoy emergency wreck marking; buoy installation; buoy isolated danger; buoy safe water; buoy special purpose/general; mooring/warping facility.

<u>Feature/Information associations</u>							
Type	Association Name	Association Ends					
		Class	Role	Mult	Class	Role	Mult
Comp	Structure/Equipment	Buoy Lateral	Supported by	0,1	Daymark, Fog Signal, Light All Around, Light Fog Detector, Physical AIS Aid to Navigation, Radar Transponder Beacon, Retroreflector, Signal Station Traffic, Signal Station Warning	Supports	1,*
Asso	Aids to Navigation Association	Buoy Lateral	Consists of	1,*	Archipelagic Sea Lane, Deep Water Route, Fairway System, Traffic Separation Scheme, Two-Way Route	Component of	0,1

20.2 Cardinal buoys

IHO Definition: **BUOY, CARDINAL**. A buoy is a floating object moored to the bottom in a particular place, as an aid to navigation or for other specific purposes. (IHO Dictionary – S-32).

A cardinal buoy is used in conjunction with the compass to indicate where the mariner may find the best navigable water. It is placed in one of the four quadrants (North, East, South and West), bounded by inter-cardinal bearings from the point marked. (UKHO NP 735, 5th Edition).

S-101 Geo Feature: Buoy cardinal (BOYCAR)

Primitives: Point

<i>Real World</i>	<i>Paper Chart Symbol</i>	<i>ECDIS Symbol</i>		
S-101 Attribute	S-57 Acronym	Allowable Encoding Value	Type	Multiplicity
Buoy shape	(BOYSHP)	1 : conical (nun, ogival) 2 : can (cylindrical) 3 : spherical 4 : pillar 5 : spar (spindle) 6 : barrel (tun) 7 : superbuoy 8 : ice buoy	EN	1,1
Category of cardinal mark	(CATCAM)	1 : north cardinal mark 2 : east cardinal mark 3 : south cardinal mark 4 : west cardinal mark	EN	1,1
Colour	(COLOUR)	1 : white 2 : black 3 : red 4 : green 5 : blue 6 : yellow 7 : grey 8 : brown 9 : amber 10 : violet 11 : orange 12 : magenta 13 : pink	EN	1,* (ordered)
Colour pattern	(COLPAT)	1 : horizontal stripes 2 : vertical stripes 3 : diagonal stripes 4 : squared 5 : stripes (direction unknown) 6 : border stripe	EN	0,1
Feature name			C	0,*
Display name			(S) BO	0,1
Language		ISO 639-3	(S) TE	0,1
Name	(OBJNAM) (NOBJNM)		(S) TE	1,1
Fixed date range			C	0,1

Date end	(DATEND)	ISO 8601: 2004	(S) TD	0,1
Date start	(DATSTA)	ISO 8601: 2004	(S) TD	0,1
Marks navigational – system of	(MARSYS)	1 : IALA A 2 : IALA B 9 : no system 11 : CEVNI	EN	0,1
Nature of construction	(NATCON)	6 : wooden 7 : metal 8 : glass reinforced plastic (GRP) 11 : latticed	EN	0,*
Periodic date range			C	0,*
Date end	(PEREND)	ISO 8601: 2004	(S) TD	1,1
Date start	(PERSTA)	ISO 8601: 2004	(S) TD	1,1
Radar conspicuous	(CONRAD)		BO	0,1
Status	(STATUS)	1 : permanent 2 : occasional 5 : periodic/intermittent 7 : temporary 8 : private 18 : existence doubtful	EN	0,*
Topmark	(TOPMAR)		C	0,1
Colour	(COLOUR)	1 : white 2 : black 3 : red 4 : green 5 : blue 6 : yellow 7 : grey 8 : brown 9 : amber 10 : violet 11 : orange 12 : magenta 13 : pink	(S) EN	0,1
Topmark/daymark shape	(TOPSHP)	1 : cone, point up 2 : cone, point down 3 : sphere 4 : 2 spheres 5 : cylinder (can) 6 : board 7 : x-shape (St. Andrew's cross) 8 : upright cross (St George's cross) 9 : cube, point up 10 : 2 cones, point to point 11 : 2 cones, base to base 12 : rhombus (diamond) 13 : 2 cones (points upward) 14 : 2 cones (points downward) 15 : besom, point up (broom or perch) 16 : besom, point down (broom or perch) 17 : flag 18 : sphere over rhombus 19 : square 20 : rectangle, horizontal	(S) EN	1,1

		21 : rectangle, vertical 22 : trapezium, up 23 : trapezium, down 24 : triangle, point up 25 : triangle, point down 26 : circle 27 : two upright crosses (one over the other) 28 : T-shape 29 : triangle pointing up over a circle 30 : upright cross over a circle 31 : rhombus over a circle 32 : circle over a triangle pointing up 33 : other shape (see shape information)		
Shape information			(S) C	0,*
Language		ISO 639-3	(S) TE	0,1
Text	(INFORM) (NINFOM)		(S) TE	1,1
Vertical length	(VERLEN)		RE	0,1
Scale minimum	(SCAMIN)	See clause X.X	IN	0,1

INT 1 Reference: Q 130.3

20.2.1 Cardinal buoys (see S-4 – B-461.3 and B-467)

Cardinal marks are used in conjunction with the compass to indicate where a mariner may find best navigable water, taking their name from the quadrant in which they are placed in relation to the point marked. The mariner should pass N of a North mark, E of an East mark, etc. The shape of cardinal buoys is not significant (although they are usually pillar or spar).

To conform to the IALA Maritime Buoyage System (see clause X.X), the body has black and yellow bands, configured with black reflecting the points of the topmark cones (for example black above yellow for north). Black double-cone topmarks are an important feature of cardinal marks and are carried wherever practicable. The points are up for a north mark, down for a south mark, apart for an east mark and together for a west mark. Lights (if fitted) are white Q or VQ, uninterrupted for the north, 3 flashes for east, 6 flashes + LFI for south and 9 flashes for west (resembling an analogue clock).

If it is required to encode a buoy having the function of a cardinal mark, it must be done using the feature **Buoy Cardinal**.

IALA MARITIME BUOYAGE SYSTEM CARDINAL MARKS REGIONS A AND B

Topmarks are always fitted (when practicable),
Buoy shapes are pillar or spar.

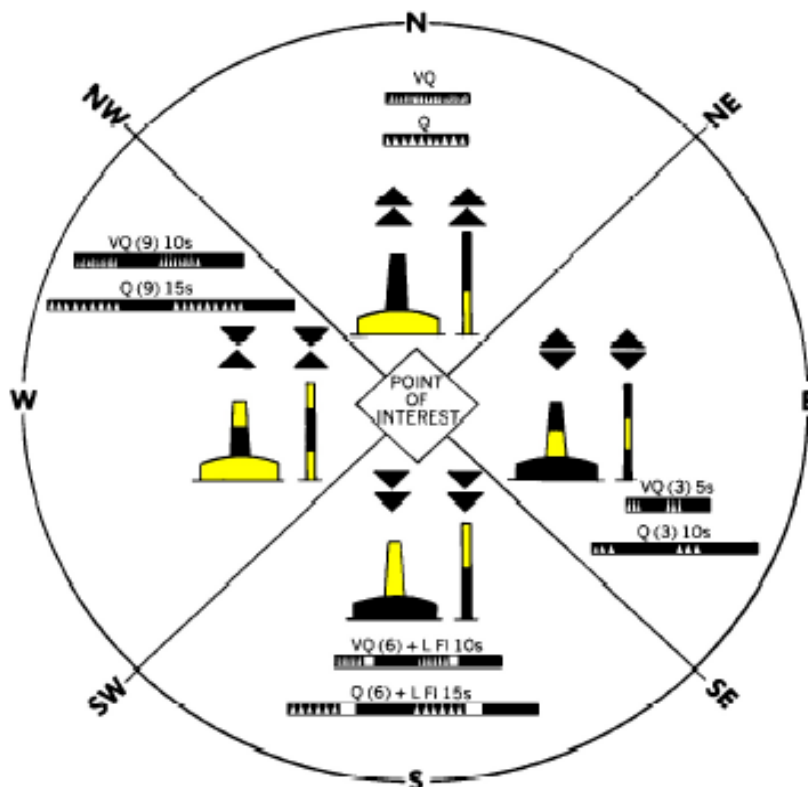

Lights, when fitted, are **white**. Very Quick Flashing or Quick Flashing; a South mark also has a Long Flash immediately following the quick flashes.

Remarks:

- If it is required to encode a buoy that has more than one colour, the attributes **colour** and **colour pattern** must be encoded, according to the rules laid out in clause X.X.
- If it is required to encode the total vertical length, including the topmark and any equipment features (for example light), of the buoy above the water level, it must be done using the attribute **vertical length**.

Distinction: Buoy emergency wreck marking; buoy installation; buoy isolated danger; buoy lateral; buoy safe water; buoy special purpose/general; mooring/warping facility.

Feature/Information associations							
Type	Association Name	Association Ends					
		Class	Role	Mult	Class	Role	Mult
Comp	Structure/Equipment	Buoy Cardinal	Supported by	0,1	Daymark, Fog Signal, Light All Around, Light Fog Detector, Physical AIS Aid to	Supports	1,*

					Navigation, Radar Transponder Beacon, Retroreflector, Signal Station Traffic, Signal Station Warning		
Asso	Aids to Navigation Association	Buoy Cardinal	Consists of	1,*	Archipelagic Sea Lane, Deep Water Route, Fairway System, Traffic Separation Scheme, Two-Way Route	Component of	0,1

20.3 Isolated danger buoys

IHO Definition: **BUOY, ISOLATED DANGER**. A buoy is a floating object moored to the bottom in a particular place, as an aid to navigation or for other specific purposes. (IHO Dictionary – S-32).

An isolated danger buoy is a buoy moored on or above an isolated danger of limited extent, which has navigable water all around it. (UKHO NP 735, 5th Edition).

S-101 Geo Feature: Buoy isolated danger (BOYISD)

Primitives: Point

<i>Real World</i>		<i>Paper Chart Symbol</i>		<i>ECDIS Symbol</i>	
S-101 Attribute	S-57 Acronym	Allowable Encoding Value	Type	Multiplicity	
Buoy shape	(BOYSHP)	1 : conical (nun, ogival) 2 : can (cylindrical) 3 : spherical 4 : pillar 5 : spar (spindle) 6 : barrel (tun) 7 : superbuoy 8 : ice buoy	EN	1,1	
Colour	(COLOUR)	1 : white 2 : black 3 : red 4 : green 5 : blue 6 : yellow 7 : grey 8 : brown 9 : amber 10 : violet 11 : orange 12 : magenta 13 : pink	EN	1,* (ordered)	
Colour pattern	(COLPAT)	1 : horizontal stripes 2 : vertical stripes 3 : diagonal stripes 4 : squared 5 : stripes (direction unknown) 6 : border stripe	EN	0,1	
Feature name			C	0,*	
Display name			(S) BO	0,1	
Language		ISO 639-3	(S) TE	0,1	
Name	(OBJNAM) (NOBJNM)		(S) TE	1,1	
Fixed date range			C	0,1	
Date end	(DATEND)	ISO 8601: 2004	(S) TD	0,1	
Date start	(DATSTA)	ISO 8601: 2004	(S) TD	0,1	
Marks navigational – system of	(MARSYS)	1 : IALA A 2 : IALA B 9 : no system	EN	0,1	

		11 : CEVNI		
Nature of construction	(NATCON)	6 : wooden 7 : metal 8 : glass reinforced plastic (GRP) 11 : latticed	EN	0,*
Periodic date range			C	0,*
Date end	(PEREND)	ISO 8601: 2004	(S) TD	1,1
Date start	(PERSTA)	ISO 8601: 2004	(S) TD	1,1
Radar conspicuous	(CONRAD)		BO	0,1
Status	(STATUS)	1 : permanent 2 : occasional 5 : periodic/intermittent 7 : temporary 8 : private 18 : existence doubtful	EN	0,*
Topmark	(TOPMAR)		C	0,1
Colour	(COLOUR)	1 : white 2 : black 3 : red 4 : green 5 : blue 6 : yellow 7 : grey 8 : brown 9 : amber 10 : violet 11 : orange 12 : magenta 13 : pink	(S) EN	0,1
Topmark/daymark shape	(TOPSHP)	1 : cone, point up 2 : cone, point down 3 : sphere 4 : 2 spheres 5 : cylinder (can) 6 : board 7 : x-shape (St. Andrew's cross) 8 : upright cross (St George's cross) 9 : cube, point up 10 : 2 cones, point to point 11 : 2 cones, base to base 12 : rhombus (diamond) 13 : 2 cones (points upward) 14 : 2 cones (points downward) 15 : besom, point up (broom or perch) 16 : besom, point down (broom or perch) 17 : flag 18 : sphere over rhombus 19 : square 20 : rectangle, horizontal 21 : rectangle, vertical 22 : trapezium, up 23 : trapezium, down 24 : triangle, point up 25 : triangle, point down 26 : circle	(S) EN	1,1

		27 : two upright crosses (one over the other) 28 : T-shape 29 : triangle pointing up over a circle 30 : upright cross over a circle 31 : rhombus over a circle 32 : circle over a triangle pointing up 33 : other shape (see shape information)		
Shape information			(S) C	0,*
Language		ISO 639-3	(S) TE	0,1
Text	(INFORM) (NINFOM)		(S) TE	1,1
Vertical length	(VERLEN)		RE	0,1
Scale minimum	(SCAMIN)	See clause X.X	IN	0,1

INT 1 Reference: Q 130.4

20.3.1 Isolated danger buoys (see S-4 – B-461.3 and B-467)

Isolated danger buoys are moored above isolated dangers of limited extent with navigable water all around them.

The shape of isolated danger buoys is not significant (although they are usually pillar or spar shaped). To conform to the IALA Maritime Buoyage System (see clause X.X), the body is black, with one or more red bands. Black double-sphere topmarks are an important feature of isolated danger buoys and carried wherever practicable. The light (if fitted) is white FI(2).

If it is required to encode a buoy having the function of an isolated danger mark, it must be done using the feature **Buoy Isolated Danger**.

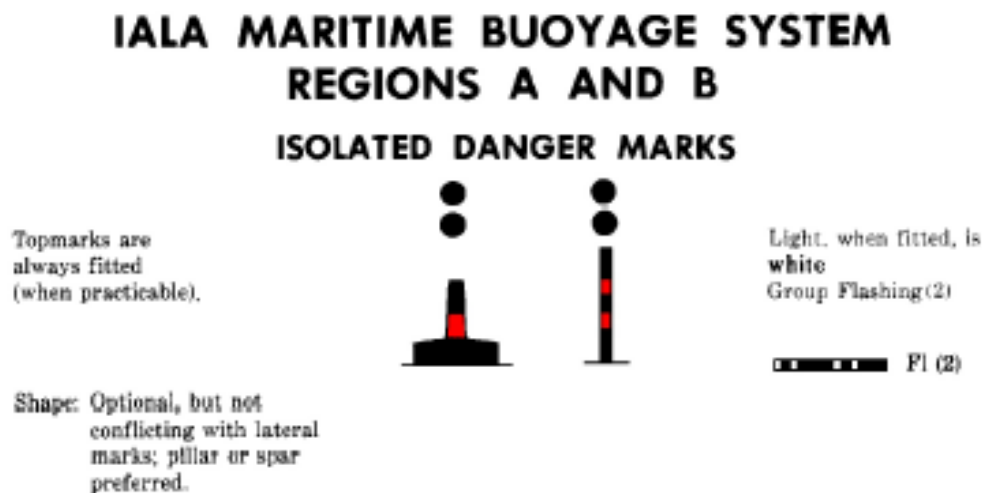

Remarks:

- If it is required to encode a buoy that has more than one colour, the attributes **colour** and **colour pattern** must be encoded, according to the rules laid out in clause X.X.
- If it is required to encode the total vertical length, including the topmark and any equipment features (for example light), of the buoy above the water level, it must be done using the attribute **vertical length**.

Distinction: Buoy cardinal; buoy emergency wreck marking; buoy installation; buoy lateral; buoy safe water; buoy special purpose/general; mooring/warping facility.

Feature/Information associations							
Type	Association Name	Association Ends					
		Class	Role	Mult	Class	Role	Mult
Comp	Structure/Equipment	Buoy Isolated Danger	Supported by	0,1	Daymark, Fog Signal, Light All Around, Light Fog Detector, Physical AIS Aid to Navigation, Radar Transponder Beacon, Retroreflector, Signal Station Traffic, Signal Station Warning	Supports	1,*
Asso	Aids to Navigation Association	Buoy Isolated Danger	Consists of	1,*	Archipelagic Sea Lane, Deep Water Route, Fairway System, Traffic Separation Scheme, Two-Way Route	Component of	0,1

20.4 Safe water buoys

IHO Definition: BUOY, SAFE WATER. A buoy is a floating object moored to the bottom in a particular place, as an aid to navigation or for other specific purposes. (IHO Dictionary – S-32).

A safe water buoy is used to indicate that there is navigable water around the mark. (UKHO NP 735, 5th Edition).

S-101 Geo Feature: Buoy safe water (BOYSAW)

Primitives: Point

<i>Real World</i>		<i>Paper Chart Symbol</i>		<i>ECDIS Symbol</i>	
S-101 Attribute	S-57 Acronym	Allowable Encoding Value	Type	Multiplicity	
Buoy shape	(BOYSHP)	1 : conical (nun, ogival) 2 : can (cylindrical) 3 : spherical 4 : pillar 5 : spar (spindle) 6 : barrel (tun) 7 : superbuoy 8 : ice buoy	EN	1,1	
Colour	(COLOUR)	1 : white 2 : black 3 : red 4 : green 5 : blue 6 : yellow 7 : grey 8 : brown 9 : amber 10 : violet 11 : orange 12 : magenta 13 : pink	EN	1,* (ordered)	
Colour pattern	(COLPAT)	1 : horizontal stripes 2 : vertical stripes 3 : diagonal stripes 4 : squared 5 : stripes (direction unknown) 6 : border stripe	EN	0,1	
Feature name			C	0,*	
Display name			(S) BO	0,1	
Language		ISO 639-3	(S) TE	0,1	
Name	(OBJNAM) (NOBJNM)		(S) TE	1,1	
Fixed date range			C	0,1	
Date end	(DATEND)	ISO 8601: 2004	(S) TD	0,1	
Date start	(DATSTA)	ISO 8601: 2004	(S) TD	0,1	
Marks navigational – system of	(MARSYS)	1 : IALA A 2 : IALA B 9 : no system	EN	0,1	

		11 : CEVNI		
Nature of construction	(NATCON)	6 : wooden 7 : metal 8 : glass reinforced plastic (GRP) 11 : latticed	EN	0,*
Periodic date range			C	0,*
Date end	(PEREND)	ISO 8601: 2004	(S) TD	1,1
Date start	(PERSTA)	ISO 8601: 2004	(S) TD	1,1
Radar conspicuous	(CONRAD)		BO	0,1
Status	(STATUS)	1 : permanent 2 : occasional 5 : periodic/intermittent 7 : temporary 8 : private 18 : existence doubtful	EN	0,*
Topmark	(TOPMAR)		C	0,1
Colour	(COLOUR)	1 : white 2 : black 3 : red 4 : green 5 : blue 6 : yellow 7 : grey 8 : brown 9 : amber 10 : violet 11 : orange 12 : magenta 13 : pink	(S) EN	0,1
Topmark/daymark shape	(TOPSHP)	1 : cone, point up 2 : cone, point down 3 : sphere 4 : 2 spheres 5 : cylinder (can) 6 : board 7 : x-shape (St. Andrew's cross) 8 : upright cross (St George's cross) 9 : cube, point up 10 : 2 cones, point to point 11 : 2 cones, base to base 12 : rhombus (diamond) 13 : 2 cones (points upward) 14 : 2 cones (points downward) 15 : besom, point up (broom or perch) 16 : besom, point down (broom or perch) 17 : flag 18 : sphere over rhombus 19 : square 20 : rectangle, horizontal 21 : rectangle, vertical 22 : trapezium, up 23 : trapezium, down 24 : triangle, point up 25 : triangle, point down 26 : circle	(S) EN	1,1

		27 : two upright crosses (one over the other) 28 : T-shape 29 : triangle pointing up over a circle 30 : upright cross over a circle 31 : rhombus over a circle 32 : circle over a triangle pointing up 33 : other shape (see shape information)		
Shape information			(S) C	0,*
Language		ISO 639-3	(S) TE	0,1
Text	(INFORM) (NINFOM)		(S) TE	1,1
Vertical length	(VERLEN)		RE	0,1
Scale minimum	(SCAMIN)	See clause X.X	IN	0,1

INT 1 Reference: Q 130.5

20.4.1 Safe water buoys (see S-4 – B-461.3 and B-467)

Safe water marks are used to indicate there is safe water all around the mark. It may be used as a centre-line, mid-channel or landfall buoy, or to mark the best point of passage under a bridge.

To conform to the IALA Maritime Buoyage System (see clause X.X), the shape of a safe water buoy is spherical, pillar or spar. The body of the mark has red and white vertical stripes. If the shape of the buoy is not spherical a red spherical topmark is carried wherever practicable. The light (if fitted) is white Oc, Iso, LFI or Mo(A) with a period of 10s.

If it is required to encode a buoy having the function of a safe water mark, it must be done using the feature **Buoy Safe Water**.

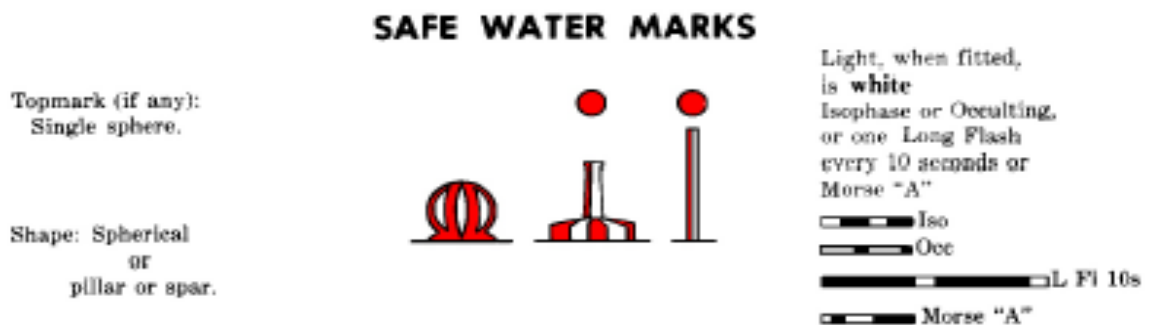

Remarks:

- If it is required to encode a buoy that has more than one colour, the attributes **colour** and **colour pattern** must be encoded, according to the rules laid out in clause X.X.
- If it is required to encode the total vertical length, including the topmark and any equipment features (for example light), of the buoy above the water level, it must be done using the attribute **vertical length**.

Distinction: Buoy cardinal; buoy emergency wreck marking; buoy installation; buoy isolated danger; buoy lateral; buoy special purpose/general; mooring/warping facility.

Feature/Information associations							
Type	Association Name	Association Ends					
		Class	Role	Mult	Class	Role	Mult

Comp	Structure/Equipment	Buoy Safe Water	Supported by	0,1	Daymark, Fog Signal, Light All Around, Light Fog Detector, Physical AIS Aid to Navigation, Radar Transponder Beacon, Retroreflector, Signal Station Traffic, Signal Station Warning	Supports	1,*
Asso	Aids to Navigation Association	Buoy Safe Water	Consists of	1,*	Archipelagic Sea Lane, Deep Water Route, Fairway System, Traffic Separation Scheme, Two-Way Route	Component of	0,1

20.5 Special purpose/general buoys

IHO Definition: BUOY, SPECIAL PURPOSE/GENERAL. A buoy is a floating object moored to the bottom in a particular place, as an aid to navigation or for other specific purposes. (IHO Dictionary – S-32).

A special purpose buoy is primarily used to indicate an area or feature, the nature of which is apparent from reference to a chart, Sailing Directions or Notices to Mariners. (UKHO NP 735, 5th Edition).

S-101 Geo Feature: Buoy special purpose/general (BOYSPP)

Primitives: Point

<i>Real World</i>		<i>Paper Chart Symbol</i>		<i>ECDIS Symbol</i>	
S-101 Attribute	S-57 Acronym	Allowable Encoding Value	Type	Multiplicity	
Buoy shape	(BOYSHP)	1 : conical (nun, ogival) 2 : can (cylindrical) 3 : spherical 4 : pillar 5 : spar (spindle) 6 : barrel (tun) 7 : superbuoy 8 : ice buoy	EN	1,1	
Category of special purpose mark	(CATSPM)	1 : firing danger area mark 2 : target mark 3 : marker ship mark 4 : degaussing range mark 5 : barge mark 6 : cable mark 7 : spoil ground mark 8 : outfall mark 9 : ODAS (Ocean-Data Acquisition-System) buoy 10 : recording mark 11 : seaplane anchorage mark 12 : recreation zone mark 14 : mooring mark 15 : LANBY (Large Automatic Navigational Buoy) 17 : measured distance mark 18 : notice mark 19 : TSS mark (Traffic Separation Scheme) 20 : anchoring prohibited mark 21 : berthing prohibited mark 22 : overtaking prohibited mark 23 : two-way traffic prohibited mark 24 : reduced wake mark 25 : speed limit mark 26 : stop mark 27 : general warning mark 28 : sound ship's siren mark 29 : restricted vertical	EN	1,*	

		clearance mark 30 : maximum vessel's draught mark 31 : restricted horizontal clearance mark 32 : strong current warning mark 33 : berthing permitted mark 34 : overhead power cable mark 35 : channel edge gradient mark 36 : telephone mark 37 : ferry crossing mark 39 : pipeline mark 40 : anchorage mark 42 : control mark 43 : diving mark 45 : foul ground mark 46 : yachting mark 47 : heliport mark 48 : GNSS mark 49 : seaplane landing mark 50 : entry prohibited mark 51 : work in progress mark 52 : mark with unknown purpose 53 : wellhead mark 54 : channel separation mark 55 : marine farm mark 56 : artificial reef mark 57 : ice mark 58 : nature reserve mark 59 : fish aggregating device (FAD) 60 : wreck mark 61 : customs mark 62 : causeway mark 63 : wave recorder		
Colour	(COLOUR)	1 : white 2 : black 3 : red 4 : green 5 : blue 6 : yellow 7 : grey 8 : brown 9 : amber 10 : violet 11 : orange 12 : magenta 13 : pink	EN	1,* (ordered)
Colour pattern	(COLPAT)	1 : horizontal stripes 2 : vertical stripes 3 : diagonal stripes 4 : squared 5 : stripes (direction unknown) 6 : border stripe	EN	0,1
Feature name			C	0,*
Display name			(S) BO	0,1
Language		ISO 639-3	(S) TE	0,1

Name	(<i>OBJNAM</i>) (<i>NOBJNM</i>)		(S) TE	1,1
Fixed date range			C	0,1
Date end	(DATEND)	ISO 8601: 2004	(S) TD	0,1
Date start	(DATSTA)	ISO 8601: 2004	(S) TD	0,1
Marks navigational – system of	(MARSYS)	1 : IALA A 2 : IALA B 9 : no system 11 : CEVNI	EN	0,1
Nature of construction	(NATCON)	6 : wooden 7 : metal 8 : glass reinforced plastic (GRP) 11 : latticed	EN	0,*
Periodic date range			C	0,*
Date end	(<i>PEREND</i>)	ISO 8601: 2004	(S) TD	1,1
Date start	(<i>PERSTA</i>)	ISO 8601: 2004	(S) TD	1,1
Radar conspicuous	(CONRAD)		BO	0,1
Status	(STATUS)	1 : permanent 2 : occasional 5 : periodic/intermittent 7 : temporary 8 : private 18 : existence doubtful	EN	0,*
Topmark	(<i>TOPMAR</i>)		C	0,1
Colour	(COLOUR)	1 : white 2 : black 3 : red 4 : green 5 : blue 6 : yellow 7 : grey 8 : brown 9 : amber 10 : violet 11 : orange 12 : magenta 13 : pink	(S) EN	0,1
Topmark/daymark shape	(TOPSHP)	1 : cone, point up 2 : cone, point down 3 : sphere 4 : 2 spheres 5 : cylinder (can) 6 : board 7 : x-shape (St. Andrew's cross) 8 : upright cross (St George's cross) 9 : cube, point up 10 : 2 cones, point to point 11 : 2 cones, base to base 12 : rhombus (diamond) 13 : 2 cones (points upward) 14 : 2 cones (points downward) 15 : besom, point up (broom or perch) 16 : besom, point down	(S) EN	1,1

		(broom or perch) 17 : flag 18 : sphere over rhombus 19 : square 20 : rectangle, horizontal 21 : rectangle, vertical 22 : trapezium, up 23 : trapezium, down 24 : triangle, point up 25 : triangle, point down 26 : circle 27 : two upright crosses (one over the other) 28 : T-shape 29 : triangle pointing up over a circle 30 : upright cross over a circle 31 : rhombus over a circle 32 : circle over a triangle pointing up 33 : other shape (see shape information)		
Shape information			(S) C	0,*
Language		ISO 639-3	(S) TE	0,1
Text	(INFORM) (NINFOM)		(S) TE	1,1
Vertical length	(VERLEN)		RE	0,1
Scale minimum	(SCAMIN)	See clause X.X	IN	0,1

INT 1 Reference: Q 50-62, 130.6

20.5.1 Special purpose/general buoys (see S-4 – B-461.3 and B-467)

Special marks are used to indicate to the mariner a special area or feature, the nature of which is usually apparent from the ENC, paper chart or associated publication. Special marks may also be used to mark a channel within a channel (for example a Deep Water route), using yellow buoys of the appropriate lateral shape, or yellow spherical buoys to mark the centreline. A special buoy may be any shape but must not conflict with lateral or safe water marks (for example an outfall buoy on the port-side of a channel could be conical but should not be conical).

To conform to the IALA Maritime Buoyage System (see clause X.X), the body of the buoy is yellow. The topmark (if fitted) is a yellow diagonal 'X' (St Andrew's cross). Lights (if fitted) are yellow and of any rhythm except those used for cardinal, isolated danger and safe water marks.

If it is required to encode a buoy having the function of a special purpose mark, or a buoy whose appearance or purpose is inadequately known, it must be done using the feature **Buoy Special Purpose/General**.

In the following table, a blank indicates that the encoder may choose a relevant value for the attribute. The table contains the most common examples of coding; other coding combinations are possible for **Buoy Special Purpose/General** features. Where the Other Attributes column in the table is listed, this applies to an associated instance of the information class **Nautical Information** (see clause X.X).

Feature	INT1	Feature	buoy shape	category of special purpose mark	Other attributes
Firing danger area buoy	Q50	Buoy Special Purpose/General		1	
Target	Q51	Buoy Special Purpose/General		2	
Marker ship	Q52	Buoy Special Purpose/General		3	

Barge	Q53	Buoy Special Purpose/General		5	
Degaussing range buoy	Q54	Buoy Special Purpose/General		4	
Buoy marking cable	Q55	Buoy Special Purpose/General		6	
Spoil ground buoy	Q56	Buoy Special Purpose/General		7	
Buoy marking outfall	Q57	Buoy Special Purpose/General		8	
Buoy marking pipeline		Buoy Special Purpose/General		39	
Superbuoy	Q26	Buoy ***	7		
Large automatic navigational buoy	P6	Buoy Special Purpose/General	7	15	
Ocean data acquisition system (ODAS) buoy	Q58	Buoy Special Purpose/General		9	Subsurface ODAS encoded as Obstruction (see clause X.X)
Buoy marking wave recorder (or current meter)	Q59	Buoy Special Purpose/General		10	information = wave recorder (for example)
Seaplane anchorage buoy	Q60	Buoy Special Purpose/General		11	
Buoy marking traffic separation scheme	Q61	Buoy Special Purpose/General		19	
Buoy marking recreation zone	Q62	Buoy Special Purpose/General		12	
Floating waste bin		Buoy Special Purpose/General		<i>Empty (null) value</i>	information = waste bin (for example)
Fish Aggregating Device (FAD)		Buoy Special Purpose/General	/	59	Fish havens are encoded as Obstruction (see clause X.X)

Remarks:

- If it is required to encode a buoy that has more than one colour, the attributes **colour** and **colour pattern** must be encoded, according to the rules laid out in clause X.X.
- If it is required to encode the total vertical length, including the topmark and any equipment features (for example light), of the buoy above the water level, it must be done using the attribute **vertical length**.
- If a special purpose buoy does not conform to the system of navigational marks defined by **Navigational System of Marks** (see clause X.X), the attribute **marks navigational – system of** on the **Buoy Special Purpose/General** should be populated as 9 (no system).
- Fish havens (sometimes referred to as subsurface Fish Aggregating Devices (FAD)) and subsurface Ocean Data Acquisition System (ODAS) equipment must be encoded, where required, using an **Obstruction** feature (see clause X.X).
- A buoy deployed as an emergency measure to mark a wreck must be encoded using the feature **Buoy Emergency Wreck Marking** (see clause X.X). A special purpose buoy intended to permanently mark a wreck as a danger must be encoded, where required, as a **Buoy Special Purpose/General** feature, with attribute **category of special purpose mark** = 60 (wreck mark).

Distinction: Buoy cardinal; buoy emergency wreck marking; buoy installation; buoy isolated danger; buoy lateral; buoy safe water; mooring/warping facility.

Feature/Information associations

Type	Association	Association Ends
------	-------------	------------------

	Name	Class	Role	Mult	Class	Role	Mult
Comp	Structure/Equipment	Buoy Special Purpose/General	Supported by	0,1	Daymark, Fog Signal, Light All Around, Light Fog Detector, Physical AIS Aid to Navigation, Radar Transponder Beacon, Retroreflector, Signal Station Traffic, Signal Station Warning	Supports	1,*
Asso	Aids to Navigation Association	Buoy Special Purpose/General	Consists of	1,*	Archipelagic Sea Lane, Deep Water Route, Fairway System, Traffic Separation Scheme, Two-Way Route	Component of	0,1

20.6 Emergency wreck marking buoys

IHO Definition: **BUOY, EMERGENCY WRECK MARKING**. A buoy is a floating object moored to the bottom in a particular place, as an aid to navigation or for other specific purposes. (IHO Dictionary – S-32).

An emergency wreck marking buoy is a buoy moored on or above a new wreck, designed to provide a prominent (both visual and radio) and easily identifiable temporary (24-72 hours) first response. (UKHO NP 735, 6th Edition).

S-101 Geo Feature: Buoy emergency wreck marking

Primitives: Point

<i>Real World</i>	<i>Paper Chart Symbol</i>	<i>ECDIS Symbol</i>		
S-101 Attribute	S-57 Acronym	Allowable Encoding Value	Type	Multiplicity
Buoy shape	(BOYSHP)	1 : conical (nun, ogival) 2 : can (cylindrical) 3 : spherical 4 : pillar 5 : spar (spindle) 6 : barrel (tun) 7 : superbuoy 8 : ice buoy	EN	1,1
Colour	(COLOUR)	1 : white 2 : black 3 : red 4 : green 5 : blue 6 : yellow 7 : grey 8 : brown 9 : amber 10 : violet 11 : orange 12 : magenta 13 : pink	EN	1,* (ordered)
Colour pattern	(COLPAT)	1 : horizontal stripes 2 : vertical stripes 3 : diagonal stripes 4 : squared 5 : stripes (direction unknown) 6 : border stripe	EN	0,1
Feature name			C	0,*
Display name			(S) BO	0,1
Language		ISO 639-3	(S) TE	0,1
Name	(OBJNAM) (NOBJNM)		(S) TE	1,1
Fixed date range			C	0,1
Date end	(DATEND)	ISO 8601: 2004	(S) TD	0,1
Date start	(DATSTA)	ISO 8601: 2004	(S) TD	0,1
Marks navigational – system of	(MARSYS)	1 : IALA A 2 : IALA B	EN	0,1

		9 : no system 11 : CEVNI		
Nature of construction	(NATCON)	6 : wooden 7 : metal 8 : glass reinforced plastic (GRP) 11 : latticed	EN	0,*
Radar conspicuous	(CONRAD)		BO	0,1
Topmark	(<i>TOPMAR</i>)		C	0,1
Colour	(COLOUR)	1 : white 2 : black 3 : red 4 : green 5 : blue 6 : yellow 7 : grey 8 : brown 9 : amber 10 : violet 11 : orange 12 : magenta 13 : pink	(S) EN	0,1
Topmark/daymark shape	(TOPSHP)	1 : cone, point up 2 : cone, point down 3 : sphere 4 : 2 spheres 5 : cylinder (can) 6 : board 7 : x-shape (St. Andrew's cross) 8 : upright cross (St George's cross) 9 : cube, point up 10 : 2 cones, point to point 11 : 2 cones, base to base 12 : rhombus (diamond) 13 : 2 cones (points upward) 14 : 2 cones (points downward) 15 : besom, point up (broom or perch) 16 : besom, point down (broom or perch) 17 : flag 18 : sphere over rhombus 19 : square 20 : rectangle, horizontal 21 : rectangle, vertical 22 : trapezium, up 23 : trapezium, down 24 : triangle, point up 25 : triangle, point down 26 : circle 27 : two upright crosses (one over the other) 28 : T-shape 29 : triangle pointing up over a circle 30 : upright cross over a circle 31 : rhombus over a circle 32 : circle over a triangle pointing up 33 : other shape (see shape)	(S) EN	1,1

		information)		
Shape information			(S) C	0,*
Language		ISO 639-3	(S) TE	0,1
Text	(INFORM) (NINFOM)		(S) TE	1,1
Vertical length	(VERLEN)		RE	0,1
Scale minimum	(SCAMIN)	See clause X.X	IN	0,1

INT 1 Reference: ?????

20.6.1 Emergency wreck marking buoys (see S-4 – B-461.3 and B-467)

Emergency wreck marking buoys are used to mark new dangers until a permanent form of marking has been established and the danger itself has been promulgated by Notice to Mariners, or removed.

To conform to the IALA Maritime Buoyage System (see clause X.X), the shape of an emergency wreck marking buoy is pillar or spar. The body of the mark has blue and yellow vertical stripes. The topmark (if fitted) is a standing/upright yellow '+' (St. George's cross). Lights (if fitted) are Al.Oc.BuY.3s.

If it is required to encode a buoy having the function of an emergency wreck mark, it must be done using the feature **Buoy emergency wreck marking**.

[diagram]

Remarks:

- If it is required to encode a buoy that has more than one colour, the attributes **colour** and **colour pattern** must be encoded, according to the rules laid out in clause X.X.
- If it is required to encode the total vertical length, including the topmark and any equipment features (for example light), of the buoy above the water level, it must be done using the attribute **vertical length**.
- An IALA compliant emergency wreck marking buoy topmark should be populated using the complex attribute **topmark**, with sub-attributes **topmark shape** = 8 (upright cross (St George's cross)) and **colour** = 6 (yellow).
- An IALA compliant emergency wreck marking buoy should also have the following associated equipment features:
 - A **Light All Around** feature (see clause X.X), with attributes **colour** = 5,6 (blue, yellow), **light characteristic** = 17 (occulting alternating), **signal group** = (1) and **signal period** = 3. The attribute **signal sequence** should be populated as 1.00+(0.50)+1.00+(0.50) and the attribute **value of nominal range** should be populated as 4.
 - A **Radar Transponder Beacon** feature (see clause X.X), with attributes **category of radar transponder beacon** = 2 (racon, radar transponder beacon) and **signal group** = (D).

Distinction: Buoy cardinal; buoy installation; buoy lateral; buoy safe water; buoy special purpose/general; mooring/warping facility.

<u>Feature/Information associations</u>							
Type	Association Name	Association Ends					
		Class	Role	Mult	Class	Role	Mult
Comp	Structure/Equipment	Buoy Lateral	Supported by	0,1	Daymark, Fog Signal, Light All Around, Light Fog Detector, Physical AIS Aid to Navigation, Radar Transponder Beacon, Retroreflector, Signal Station Traffic, Signal Station Warning	Supports	1,*

20.7 Installation buoys

IHO Definition: **BUOY, INSTALLATION.** A buoy is a floating object moored to the bottom in a particular place, as an aid to navigation or for other specific purposes. (IHO Dictionary – S-32).

An installation buoy is a buoy used for loading tankers with gas or oil. (S-57 Edition 3.1, Appendix A – Chapter 1, Page 1.20, November 2000).

S-101 Geo Feature: Buoy installation (BOYINB)

Primitives: Point

<i>Real World</i>		<i>Paper Chart Symbol</i>		<i>ECDIS Symbol</i>	
S-101 Attribute	S-57 Acronym	Allowable Encoding Value	Type	Multiplicity	
Buoy shape	(BOYSHP)	1 : conical (nun, ogival) 2 : can (cylindrical) 3 : spherical 4 : pillar 5 : spar (spindle) 6 : barrel (tun) 7 : superbuoy 8 : ice buoy	EN	1,1	
Category of installation buoy	(CATINB)	1 : catenary anchor leg mooring (CALM) 2 : single buoy mooring (SBM or SPM)	EN	0,1	
Colour	(COLOUR)	1 : white 2 : black 3 : red 4 : green 5 : blue 6 : yellow 7 : grey 8 : brown 9 : amber 10 : violet 11 : orange 12 : magenta 13 : pink	EN	1,* (ordered)	
Colour pattern	(COLPAT)	1 : horizontal stripes 2 : vertical stripes 3 : diagonal stripes 4 : squared 5 : stripes (direction unknown) 6 : border stripe	EN	0,1	
Feature name			C	0,*	
Display name			(S) BO	0,1	
Language		ISO 639-3	(S) TE	0,1	
Name	(OBJNAM) (NOBJNM)		(S) TE	1,1	
Fixed date range			C	0,1	
Date end	(DATEND)	ISO 8601: 2004	(S) TD	0,1	

Date start	(DATSTA)	ISO 8601: 2004	(S) TD	0,1
Nature of construction	(NATCON)	7 : metal 11 : latticed	EN	0,*
Periodic date range			C	0,*
Date end	(PEREND)	ISO 8601: 2004	(S) TD	1,1
Date start	(PERSTA)	ISO 8601: 2004	(S) TD	1,1
Product	(PRODCT)	1 : oil 2 : gas 18 : liquefied natural gas (LNG) 19 : liquefied petroleum gas (LPG)	EN	0,1
Radar conspicuous	(CONRAD)		BO	0,1
Status	(STATUS)	1 : permanent 2 : occasional 4 : not in use 5 : periodic/intermittent 7 : temporary 8 : private 18 : existence doubtful	EN	0,*
Visually conspicuous	(CONVIS)	1 : visually conspicuous 2 : not visually conspicuous 3 : prominent	EN	0,1
Scale minimum	(SCAMIN)	See clause X.X	IN	0,1

INT 1 Reference: L 16

20.7.1 Installation buoys (see S-4 – B-445.4)

Although the oil and gas from some fields are sent ashore by submarine pipeline, a variety of mooring systems have been developed for use in deep water and in the vicinity of certain ports, to allow the loading of large vessels and the permanent mooring of floating storage vessels or units. These offshore systems include large mooring buoys, designed for mooring vessels up to 500,000 tonnes, and platforms on structures fixed at their lower ends to the sea floor. They allow a vessel to moor forward or aft to them, and to swing to the wind or stream, and are termed installation buoys.

If it is required to encode an installation buoy, it must be done using the feature **Buoy Installation**.

Remarks:

- If it is required to encode a buoy that has more than one colour, the attributes **colour** and **colour pattern** must be encoded, according to the rules laid out in clause X.X.
- If it is required to encode the total vertical length, including any equipment features (for example light), of the buoy above the water level, it must be done using the attribute **vertical length**.

Distinction: Buoy special purpose/general; mooring/warping facility; offshore platform.

Feature/Information associations							
Type	Association Name	Association Ends					
		Class	Role	Mult	Class	Role	Mult
Comp	Structure/Equipment	Buoy Installation	Supported by	0,1	Daymark, Fog Signal, Light All Around, Light Fog Detector, Physical AIS Aid to Navigation, Radar Transponder Beacon, Retroreflector, Signal Station Traffic, Signal	Supports	1,*

					Station Warning		
--	--	--	--	--	------------------------	--	--

20.8 Lateral beacons

IHO Definition: BEACON LATERAL. A beacon is a prominent specially constructed object forming a conspicuous mark as a fixed aid to navigation or for use in hydrographic survey. (IHO Dictionary – S-32).

A lateral beacon is used to indicate the port or starboard hand side of the route to be followed. They are generally used for well defined channels and are used in conjunction with a conventional direction of buoyage. (UKHO NP 735, 5th Edition).

S-101 Geo Feature: Beacon lateral (BCNLAT)

Primitives: Point

<i>Real World</i>	<i>Paper Chart Symbol</i>	<i>ECDIS Symbol</i>
-------------------	---------------------------	---------------------

S-101 Attribute	S-57 Acronym	Allowable Encoding Value	Type	Multiplicity
Beacon shape	(BCNSHP)	1 : stake, pole, perch, post 2 : withy 3 : beacon tower 5 : pile beacon 6 : cairn 7 : buoyant beacon	EN	1,1
Category of lateral mark	(CATLAM)	1 : port-hand lateral mark 2 : starboard-hand lateral mark 3 : preferred channel to starboard lateral mark 4 : preferred channel to port lateral mark	EN	1,1
Colour	(COLOUR)	1 : white 2 : black 3 : red 4 : green 5 : blue 6 : yellow 7 : grey 8 : brown 9 : amber 10 : violet 11 : orange 12 : magenta 13 : pink	EN	1,* (ordered)
Colour pattern	(COLPAT)	1 : horizontal stripes 2 : vertical stripes 3 : diagonal stripes 4 : squared 5 : stripes (direction unknown) 6 : border stripe	EN	0,1
Condition	(CONDTN)	1 : under construction 2 : ruined 5 : planned construction	EN	0,1
Elevation	(ELEVAT)		RE	0,1
Feature name			C	0,*
Display name			(S) BO	0,1

Language		ISO 639-3	(S) TE	0,1
Name	(<i>OBJNAM</i>) (<i>NOBJNM</i>)		(S) TE	1,1
Fixed date range			C	0,1
Date end	(DATEND)	ISO 8601: 2004	(S) TD	0,1
Date start	(DATSTA)	ISO 8601: 2004	(S) TD	0,1
Height	(HEIGHT)		RE	0,1
Marks navigational – system of	(MARSYS)	1 : IALA A 2 : IALA B 9 : no system 11 : CEVNI	EN	0,1
Nature of construction	(NATCON)	1 : masonry 2 : concreted 6 : wooden 7 : metal 8 : glass reinforced plastic (GRP) 11 : latticed	EN	0,*
Periodic date range			C	0,*
Date end	(<i>PEREND</i>)	ISO 8601: 2004	(S) TD	1,1
Date start	(<i>PERSTA</i>)	ISO 8601: 2004	(S) TD	1,1
Radar conspicuous	(CONRAD)		BO	0,1
Reported date	(<i>SORDAT</i>)	ISO 8601: 2004	TD	0,1
Status	(STATUS)	1 : permanent 2 : occasional 4 : not in use 5 : periodic/intermittent 7 : temporary 8 : private 12 : illuminated 18 : existence doubtful	EN	0,*
Topmark	(<i>TOPMAR</i>)		C	0,1
Colour	(COLOUR)	1 : white 2 : black 3 : red 4 : green 5 : blue 6 : yellow 7 : grey 8 : brown 9 : amber 10 : violet 11 : orange 12 : magenta 13 : pink	(S) EN	0,1
Topmark/daymark shape	(TOPSHP)	1 : cone, point up 2 : cone, point down 3 : sphere 4 : 2 spheres 5 : cylinder (can) 6 : board 7 : x-shape (St. Andrew's cross) 8 : upright cross (St George's cross) 9 : cube, point up 10 : 2 cones, point to point	(S) EN	1,1

		11 : 2 cones, base to base 12 : rhombus (diamond) 13 : 2 cones (points upward) 14 : 2 cones (points downward) 15 : besom, point up (broom or perch) 16 : besom, point down (broom or perch) 17 : flag 18 : sphere over rhombus 19 : square 20 : rectangle, horizontal 21 : rectangle, vertical 22 : trapezium, up 23 : trapezium, down 24 : triangle, point up 25 : triangle, point down 26 : circle 27 : two upright crosses (one over the other) 28 : T-shape 29 : triangle pointing up over a circle 30 : upright cross over a circle 31 : rhombus over a circle 32 : circle over a triangle pointing up 33 : other shape (see shape information)		
Shape information			(S) C	0,*
Language		ISO 639-3	(S) TE	0,1
Text	(INFORM) (NINFOM)		(S) TE	1,1
Vertical length	(VERLEN)		RE	0,1
Visually conspicuous	(CONVIS)	1 : visually conspicuous 2 : not visually conspicuous 3 : prominent	EN	0,1
Scale minimum	(SCAMIN)	See clause X.X	IN	0,1

INT 1 Reference: Q 91-92, 130.1

20.8.1 Lateral Beacons (see S-4 – B-461.3 and B-467)

Lateral beacons are generally used for well defined channels, in conjunction with a direction of buoyage. They indicate the port and starboard sides of the route to be followed.

To conform to the IALA Maritime Buoyage System (see clause **X.X**), port hand beacons have a can shaped topmark. The colour of port hand beacons, topmarks and lights (if fitted) will be red in IALA region A and green in IALA region B.

To conform to the IALA Maritime Buoyage System, starboard hand beacons have a conical shaped topmark. The colour of starboard hand beacons, topmarks and lights (if fitted) will be green in IALA region A and red in IALA region B.

A preferred channel beacon is a modified lateral beacon, with horizontal colour bands. The predominant colour indicates which side is the preferred channel, the other colour indicates the secondary channel. If fitted, the light is Fl(2+1), the colour indicating the preferred channel.

If it is required to encode a beacon having the function of a lateral mark, it must be done using the feature **Beacon Lateral**.

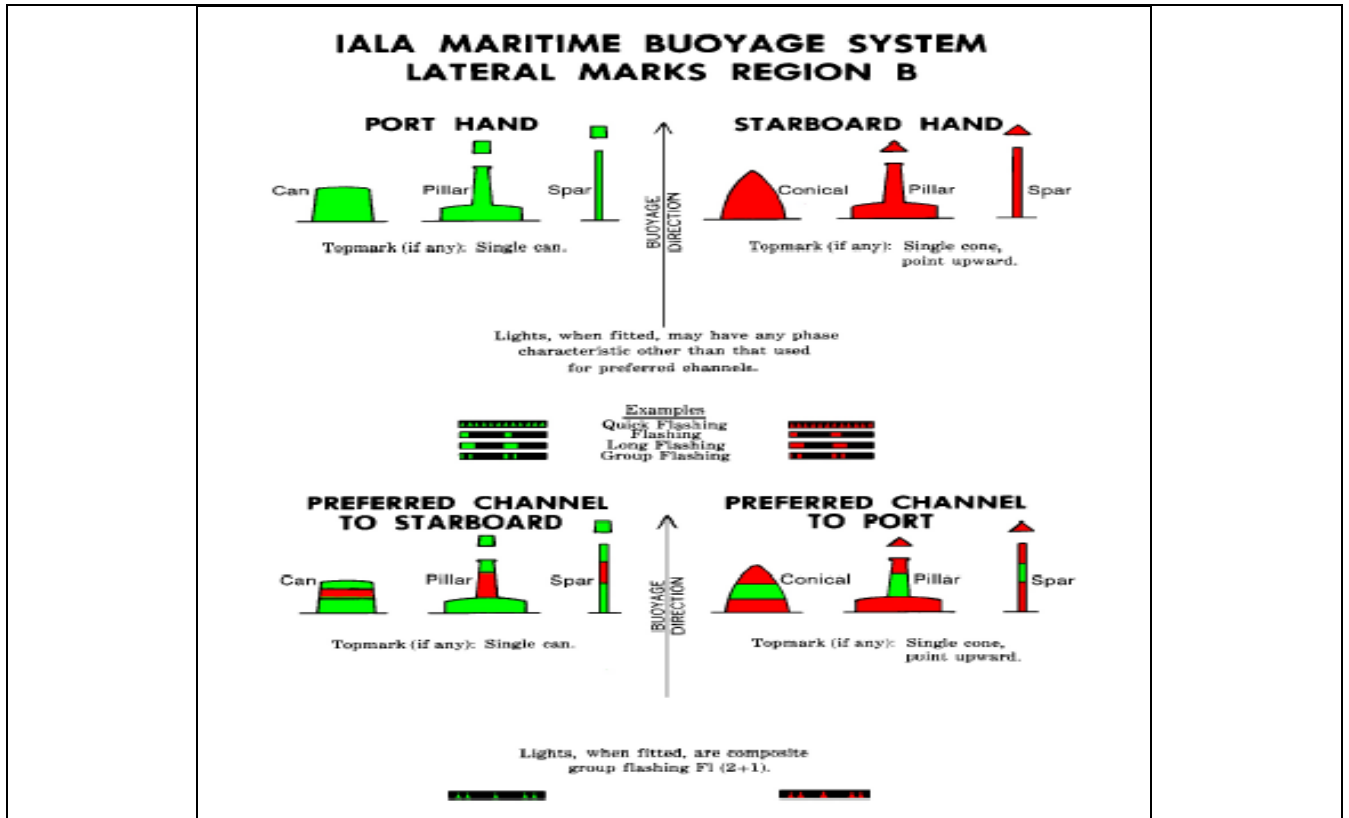

Remarks:

- If it is required to encode a beacon that has more than one colour, the attributes **colour** and **colour pattern** must be encoded, according to the rules laid out in clause X.X.
- For guidance on the encoding of the attributes **elevation**, **height** and **vertical length** see clause X.X. **Elevation** applies only to beacons on land. Values populated for **height** and **vertical length** must include the topmark and any equipment features.
- If it is required to encode a cairn that bears the colour(s) specified by a navigational system of marks, it must be done using a beacon feature.

Distinction: Beacon cardinal; beacon isolated danger; beacon safe water; beacon special purpose/general; daymark.

Feature/Information associations							
Type	Association Name	Association Ends					
		Class	Role	Mult	Class	Role	Mult
Comp	Structure/Equipment	Beacon Lateral	Supported by	0,1	Daymark, Fog Signal, Light All Around, Light Fog Detector, Light Sectored, Physical AIS Aid to Navigation, Radar Transponder Beacon, Retroreflector, Signal Station Traffic, Signal Station Warning	Supports	1,*
Aggr	Range System Aggregation	Beacon Lateral	Consists of	1,*	Range System	Component of	0,1
Asso	Aids to Navigation Association	Beacon Lateral	Consists of	1,*	Archipelagic Sea Lane, Deep Water Route, Fairway System, Traffic	Component of	0,1

					Separation Scheme, Two-Way Route		
--	--	--	--	--	---	--	--

20.9 Cardinal beacons

IHO Definition: BEACON, CARDINAL. A beacon is a prominent specially constructed object forming a conspicuous mark as a fixed aid to navigation or for use in hydrographic survey. (*IHO Dictionary – S-32*).

A cardinal beacon is used in conjunction with the compass to indicate where the mariner may find the best navigable water. It is placed in one of the four quadrants (North, East, South and West), bounded by inter-cardinal bearings from the point marked. (*UKHO NP 735, 5th Edition*).

S-101 Geo Feature: Beacon cardinal (BCNCAR)

Primitives: Point

<i>Real World</i>		<i>Paper Chart Symbol</i>		<i>ECDIS Symbol</i>	
S-101 Attribute	S-57 Acronym	Allowable Encoding Value	Type	Multiplicity	
Beacon shape	(BCNSHP)	1 : stake, pole, perch, post 2 : withy 3 : beacon tower 5 : pile beacon 6 : cairn 7 : buoyant beacon	EN	1,1	
Category of cardinal mark	(CATCAM)	1 : north cardinal mark 2 : east cardinal mark 3 : south cardinal mark 4 : west cardinal mark	EN	1,1	
Colour	(COLOUR)	1 : white 2 : black 3 : red 4 : green 5 : blue 6 : yellow 7 : grey 8 : brown 9 : amber 10 : violet 11 : orange 12 : magenta 13 : pink	EN	1,* (ordered)	
Colour pattern	(COLPAT)	1 : horizontal stripes 2 : vertical stripes 3 : diagonal stripes 4 : squared 5 : stripes (direction unknown) 6 : border stripe	EN	0,1	
Condition	(CONDTN)	1 : under construction 2 : ruined 5 : planned construction	EN	0,1	
Elevation	(ELEVAT)		RE	0,1	
Feature name			C	0,*	
Display name			(S) BO	0,1	
Language		ISO 639-3	(S) TE	0,1	
Name	(OBJNAM)		(S) TE	1,1	

	(<i>NOBJNM</i>)			
Fixed date range			C	0,1
Date end	(DATEND)	ISO 8601: 2004	(S) TD	0,1
Date start	(DATSTA)	ISO 8601: 2004	(S) TD	0,1
Height	(HEIGHT)		RE	0,1
Marks navigational – system of	(MARSYS)	1 : IALA A 2 : IALA B 9 : no system 11 : CEVNI	EN	0,1
Nature of construction	(NATCON)	1 : masonry 2 : concreted 6 : wooden 7 : metal 8 : glass reinforced plastic (GRP) 11 : latticed	EN	0,*
Periodic date range			C	0,*
Date end	(PEREND)	ISO 8601: 2004	(S) TD	1,1
Date start	(PERSTA)	ISO 8601: 2004	(S) TD	1,1
Radar conspicuous	(CONRAD)		BO	0,1
Reported date	(SORDAT)	ISO 8601: 2004	TD	0,1
Status	(STATUS)	1 : permanent 2 : occasional 4 : not in use 5 : periodic/intermittent 7 : temporary 8 : private 12 : illuminated 18 : existence doubtful	EN	0,*
Topmark	(<i>TOPMAR</i>)		C	0,1
Colour	(COLOUR)	1 : white 2 : black 3 : red 4 : green 5 : blue 6 : yellow 7 : grey 8 : brown 9 : amber 10 : violet 11 : orange 12 : magenta 13 : pink	(S) EN	0,1
Topmark/daymark shape	(TOPSHP)	1 : cone, point up 2 : cone, point down 3 : sphere 4 : 2 spheres 5 : cylinder (can) 6 : board 7 : x-shape (St. Andrew's cross) 8 : upright cross (St George's cross) 9 : cube, point up 10 : 2 cones, point to point 11 : 2 cones, base to base 12 : rhombus (diamond)	(S) EN	1,1

		13 : 2 cones (points upward) 14 : 2 cones (points downward) 15 : besom, point up (broom or perch) 16 : besom, point down (broom or perch) 17 : flag 18 : sphere over rhombus 19 : square 20 : rectangle, horizontal 21 : rectangle, vertical 22 : trapezium, up 23 : trapezium, down 24 : triangle, point up 25 : triangle, point down 26 : circle 27 : two upright crosses (one over the other) 28 : T-shape 29 : triangle pointing up over a circle 30 : upright cross over a circle 31 : rhombus over a circle 32 : circle over a triangle pointing up 33 : other shape (see shape information)		
Shape information			(S) C	0,*
Language		ISO 639-3	(S) TE	0,1
Text	(<i>INFORM</i>) (<i>NINFOM</i>)		(S) TE	1,1
Vertical length	(VERLEN)		RE	0,1
Visually conspicuous	(CONVIS)	1 : visually conspicuous 2 : not visually conspicuous 3 : prominent	EN	0,1
Scale minimum	(SCAMIN)	See clause X.X	IN	0,1

INT 1 Reference: Q 130.3

20.9.1 Cardinal beacons (see S-4 – B-461.3 and B-467)

Cardinal marks are used in conjunction with the compass to indicate where a mariner may find best navigable water, taking their name from the quadrant in which they are placed in relation to the point marked. The mariner should pass N of a North mark, E of an East mark, etc.

To conform to the IALA Maritime Buoyage System (see clause **X.X**), the body of the beacon has black and yellow bands, configured with black reflecting the points of the topmark cones (for example black above yellow for north). Black double-cone topmarks are an important feature of cardinal marks and are carried wherever practicable. The points are up for a north mark, down for a south mark, apart for an east mark and together for a west mark. Lights (if fitted) are white Q or VQ, uninterrupted for the north, 3 flashes for east, 6 flashes + LFI for south and 9 flashes for west (resembling an analogue clock).

If it is required to encode a beacon having the function of a cardinal mark, it must be done using the feature **Beacon Cardinal**.

IALA MARITIME BUOYAGE SYSTEM CARDINAL MARKS REGIONS A AND B

Topmarks are always fitted (when practicable),
Buoy shapes are pillar or spar.

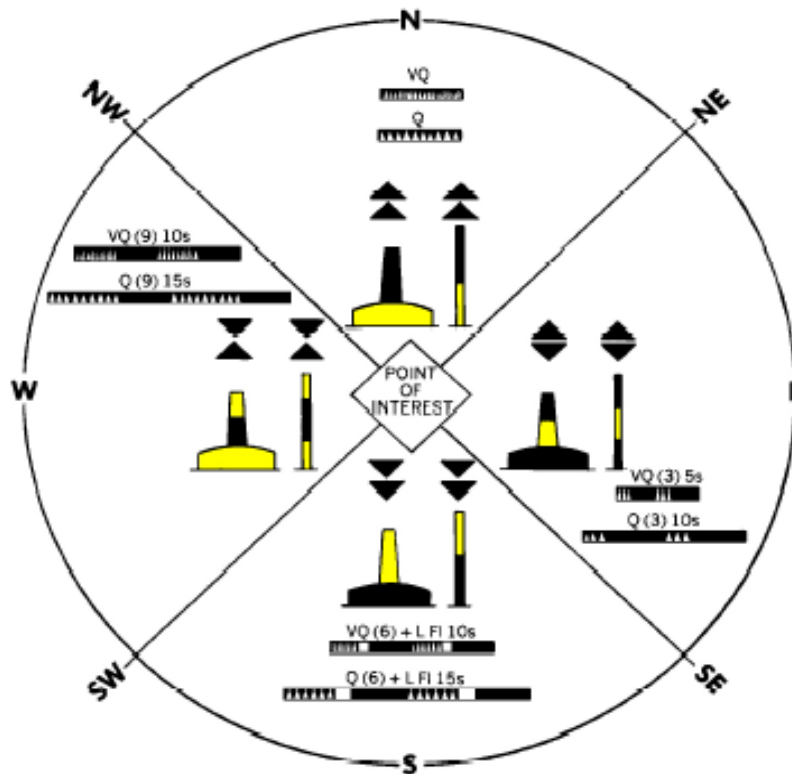

Lights, when fitted, are **white**. Very Quick Flashing or Quick Flashing; a South mark also has a Long Flash immediately following the quick flashes.

Remarks:

- If it is required to encode a beacon that has more than one colour, the attributes **colour** and **colour pattern** must be encoded, according to the rules laid out in clause X.X.
- For guidance on the encoding of the attributes **elevation**, **height** and **vertical length** see clause X.X. **Elevation** applies only to beacons on land. Values populated for **height** and **vertical length** must include the topmark and any equipment features.
- If it is required to encode a cairn that bears the colour(s) specified by a navigational system of marks, it must be done using a beacon feature.

Distinction: Beacon isolated danger; beacon lateral; beacon safe water; beacon special purpose/general; daymark.

Feature/Information associations							
Type	Association Name	Association Ends					
		Class	Role	Mult	Class	Role	Mult
Comp	Structure/Equip	Beacon	Supported by	0,1	Daymark, Fog Signal,	Supports	1,*

	ment	Cardinal			Light All Around, Light Fog Detector, Light Sectored, Physical AIS Aid to Navigation, Radar Transponder Beacon, Retroreflector, Signal Station Traffic, Signal Station Warning		
Aggr	Range System Aggregation	Beacon Cardinal	Consists of	1,*	Range System	Component of	0,1
Asso	Aids to Navigation Association	Beacon Cardinal	Consists of	1,*	Archipelagic Sea Lane, Deep Water Route, Fairway System, Traffic Separation Scheme, Two-Way Route	Component of	0,1

20.10 Isolated danger beacons

IHO Definition: **BEACON, ISOLATED DANGER.** A beacon is a prominent, specially constructed object forming a conspicuous mark as a fixed aid to navigation or for use in hydrographic survey. (IHO Dictionary – S-32).

An isolated danger beacon is a beacon erected on an isolated danger of limited extent, which has navigable water all around it. (UKHO NP735, 5th Edition).

S-101 Geo Feature: Beacon isolated danger (BCNISD)

Primitives: Point

<i>Real World</i>		<i>Paper Chart Symbol</i>		<i>ECDIS Symbol</i>	
S-101 Attribute	S-57 Acronym	Allowable Encoding Value	Type	Multiplicity	
Beacon shape	(BCNSHP)	1 : stake, pole, perch, post 2 : withy 3 : beacon tower 5 : pile beacon 6 : cairn 7 : buoyant beacon	EN	1,1	
Colour	(COLOUR)	1 : white 2 : black 3 : red 4 : green 5 : blue 6 : yellow 7 : grey 8 : brown 9 : amber 10 : violet 11 : orange 12 : magenta 13 : pink	EN	1,* (ordered)	
Colour pattern	(COLPAT)	1 : horizontal stripes 2 : vertical stripes 3 : diagonal stripes 4 : squared 5 : stripes (direction unknown) 6 : border stripe	EN	0,1	
Condition	(CONDTN)	1 : under construction 2 : ruined 5 : planned construction	EN	0,1	
Elevation	(ELEVAT)		RE	0,1	
Feature name			C	0,*	
Display name			(S) BO	0,1	
Language		ISO 639-3	(S) TE	0,1	
Name	(OBJNAM) (NOBJNM)		(S) TE	1,1	
Fixed date range			C	0,1	
Date end	(DATEND)	ISO 8601: 2004	(S) TD	0,1	

Date start	(DATSTA)	ISO 8601: 2004	(S) TD	0,1
Height	(HEIGHT)		RE	0,1
Marks navigational – system of	(MARSYS)	1 : IALA A 2 : IALA B 9 : no system 11 : CEVNI	EN	0,1
Nature of construction	(NATCON)	1 : masonry 2 : concreted 6 : wooden 7 : metal 8 : glass reinforced plastic (GRP) 11 : latticed	EN	0,*
Periodic date range			C	0,*
Date end	(PEREND)	ISO 8601: 2004	(S) TD	1,1
Date start	(PERSTA)	ISO 8601: 2004	(S) TD	1,1
Radar conspicuous	(CONRAD)		BO	0,1
Reported date	(SORDAT)	ISO 8601: 2004	TD	0,1
Status	(STATUS)	1 : permanent 2 : occasional 4 : not in use 5 : periodic/intermittent 7 : temporary 8 : private 12 : illuminated 18 : existence doubtful	EN	0,*
Topmark	(TOPMAR)		C	0,1
Colour	(COLOUR)	1 : white 2 : black 3 : red 4 : green 5 : blue 6 : yellow 7 : grey 8 : brown 9 : amber 10 : violet 11 : orange 12 : magenta 13 : pink	(S) EN	0,1
Topmark/daymark shape	(TOPSHP)	1 : cone, point up 2 : cone, point down 3 : sphere 4 : 2 spheres 5 : cylinder (can) 6 : board 7 : x-shape (St. Andrew's cross) 8 : upright cross (St George's cross) 9 : cube, point up 10 : 2 cones, point to point 11 : 2 cones, base to base 12 : rhombus (diamond) 13 : 2 cones (points upward) 14 : 2 cones (points downward) 15 : besom, point up (broom or perch)	(S) EN	1,1

		16 : besom, point down (broom or perch) 17 : flag 18 : sphere over rhombus 19 : square 20 : rectangle, horizontal 21 : rectangle, vertical 22 : trapezium, up 23 : trapezium, down 24 : triangle, point up 25 : triangle, point down 26 : circle 27 : two upright crosses (one over the other) 28 : T-shape 29 : triangle pointing up over a circle 30 : upright cross over a circle 31 : rhombus over a circle 32 : circle over a triangle pointing up 33 : other shape (see shape information)		
Shape information			(S) C	0,*
Language		ISO 639-3	(S) TE	0,1
Text	(<i>INFORM</i>) (<i>NINFOM</i>)		(S) TE	1,1
Vertical length	(VERLEN)		RE	0,1
Visually conspicuous	(CONVIS)	1 : visually conspicuous 2 : not visually conspicuous 3 : prominent	EN	0,1
Scale minimum	(SCAMIN)	See clause X.X	IN	0,1
<p><u>INT 1 Reference:</u> IQ 130.4</p> <p>20.10.1 Isolated danger beacons (see S-4 – B-461.3 and B-467)</p> <p>Isolated danger beacons are placed on isolated dangers of limited extent with navigable water all around them.</p> <p>To conform to the IALA Maritime Buoyage System (see clause X.X), the body of an isolated danger beacon is black, with one or more red bands. Black double-sphere topmarks are an important feature of isolated danger beacons and carried wherever practicable. The light (if fitted) is white FI(2).</p> <p>If it is required to encode a beacon having the function of an isolated danger mark, it must be done using the feature Beacon Isolated Danger.</p>				

IALA MARITIME BUOYAGE SYSTEM REGIONS A AND B

ISOLATED DANGER MARKS

Topmarks are always fitted (when practicable).

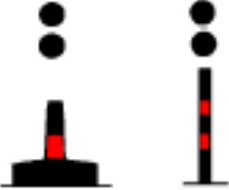

Shape: Optional, but not conflicting with lateral marks; pillar or spar preferred.

Light, when fitted, is white
Group Flashing(2)



F1 (2)

Remarks:

- If it is required to encode a beacon that has more than one colour, the attributes **colour** and **colour pattern** must be encoded, according to the rules laid out in clause X.X.
- For guidance on the encoding of the attributes **elevation**, **height** and **vertical length** see clause X.X. **Elevation** applies only to beacons on land. Values populated for **height** and **vertical length** must include the topmark and any equipment features.
- If it is required to encode a cairn that bears the colour(s) specified by a navigational system of marks, it must be done using a beacon feature.

Distinction: Beacon cardinal; beacon lateral; beacon safe water; beacon special purpose/general; daymark.

Feature/Information associations							
Type	Association Name	Association Ends					
		Class	Role	Mult	Class	Role	Mult
Comp	Structure/Equipment	Beacon Isolated Danger	Supported by	0,1	Daymark, Fog Signal, Light All Around, Light Fog Detector, Light Sector, Physical AIS Aid to Navigation, Radar Transponder Beacon, Retroreflector, Signal Station Traffic, Signal Station Warning	Supports	1,*
Aggr	Range System Aggregation	Beacon Isolated Danger	Consists of	1,*	Range System	Component of	0,1
Asso	Aids to Navigation Association	Beacon Isolated Danger	Consists of	1,*	Archipelagic Sea Lane, Deep Water Route, Fairway System, Traffic Separation Scheme, Two-Way Route	Component of	0,1

20.11 Safe water beacons

IHO Definition: BEACON, SAFE WATER. A safe water beacon is a prominent specially constructed object forming a conspicuous mark as a fixed aid to navigation or for use in hydrographic survey. (IHO Dictionary – S-32, Edition 5).

A safe water beacon is used to indicate that there is navigable water around the mark. (UKHO NP735, 5th Edition).

S-101 Geo Feature: Beacon safe water (BCNSAW)

Primitives: Point

<i>Real World</i>	<i>Paper Chart Symbol</i>	<i>ECDIS Symbol</i>
-------------------	---------------------------	---------------------

S-101 Attribute	S-57 Acronym	Allowable Encoding Value	Type	Multiplicity
Beacon shape	(BCNSHP)	1 : stake, pole, perch, post 2 : withy 3 : beacon tower 5 : pile beacon 6 : cairn 7 : buoyant beacon	EN	1,1
Colour	(COLOUR)	1 : white 2 : black 3 : red 4 : green 5 : blue 6 : yellow 7 : grey 8 : brown 9 : amber 10 : violet 11 : orange 12 : magenta 13 : pink	EN	1,* (ordered)
Colour pattern	(COLPAT)	1 : horizontal stripes 2 : vertical stripes 3 : diagonal stripes 4 : squared 5 : stripes (direction unknown) 6 : border stripe	EN	0,1
Condition	(CONDTN)	1 : under construction 2 : ruined 5 : planned construction	EN	0,1
Elevation	(ELEVAT)		RE	0,1
Feature name			C	0,*
Display name			(S) BO	0,1
Language		ISO 639-3	(S) TE	0,1
Name	(OBJNAM) (NOBJNM)		(S) TE	1,1
Fixed date range			C	0,1
Date end	(DATEND)	ISO 8601: 2004	(S) TD	0,1

Date start	(DATSTA)	ISO 8601: 2004	(S) TD	0,1
Height	(HEIGHT)		RE	0,1
Marks navigational – system of	(MARSYS)	1 : IALA A 2 : IALA B 9 : no system 11 : CEVNI	EN	0,1
Nature of construction	(NATCON)	1 : masonry 2 : concreted 6 : wooden 7 : metal 8 : glass reinforced plastic (GRP) 11 : latticed	EN	0,*
Periodic date range			C	0,*
Date end	(PEREND)	ISO 8601: 2004	(S) TD	1,1
Date start	(PERSTA)	ISO 8601: 2004	(S) TD	1,1
Radar conspicuous	(CONRAD)		BO	0,1
Reported date	(SORDAT)	ISO 8601: 2004	TD	0,1
Status	(STATUS)	1 : permanent 2 : occasional 4 : not in use 5 : periodic/intermittent 7 : temporary 8 : private 12 : illuminated 18 : existence doubtful	EN	0,*
Topmark	(TOPMAR)		C	0,1
Colour	(COLOUR)	1 : white 2 : black 3 : red 4 : green 5 : blue 6 : yellow 7 : grey 8 : brown 9 : amber 10 : violet 11 : orange 12 : magenta 13 : pink	(S) EN	0,1
Topmark/daymark shape	(TOPSHP)	1 : cone, point up 2 : cone, point down 3 : sphere 4 : 2 spheres 5 : cylinder (can) 6 : board 7 : x-shape (St. Andrew's cross) 8 : upright cross (St George's cross) 9 : cube, point up 10 : 2 cones, point to point 11 : 2 cones, base to base 12 : rhombus (diamond) 13 : 2 cones (points upward) 14 : 2 cones (points downward) 15 : besom, point up (broom or perch)	(S) EN	1,1

		16 : besom, point down (broom or perch) 17 : flag 18 : sphere over rhombus 19 : square 20 : rectangle, horizontal 21 : rectangle, vertical 22 : trapezium, up 23 : trapezium, down 24 : triangle, point up 25 : triangle, point down 26 : circle 27 : two upright crosses (one over the other) 28 : T-shape 29 : triangle pointing up over a circle 30 : upright cross over a circle 31 : rhombus over a circle 32 : circle over a triangle pointing up 33 : other shape (see shape information)		
Shape information			(S) C	0,*
Language		ISO 639-3	(S) TE	0,1
Text	(INFORM) (NINFOM)		(S) TE	1,1
Vertical length	(VERLEN)		RE	0,1
Visually conspicuous	(CONVIS)	1 : visually conspicuous 2 : not visually conspicuous 3 : prominent	EN	0,1
Scale minimum	(SCAMIN)	See clause X.X	IN	0,1

INT 1 Reference: Q 130.5

20.11.1 Safe water beacons (see S-4 – B-461.3 and B-467)

Safe water marks are used to indicate there is safe water all around the mark. It may be used as a centre-line, mid-channel or landfall beacon, or to mark the best point of passage under a bridge.

To conform to the IALA Maritime Buoyage System (see clause X.X), the body of the mark has red and white vertical stripes. A red spherical topmark is an important feature if the beacon is not spherical and carried wherever practicable. The light (if fitted) is white Oc, Iso, LFI or Mo(A) with a period of 10s.

If it is required to encode a beacon having the function of a safe water mark, it must be done using the feature **Beacon Safe Water**.

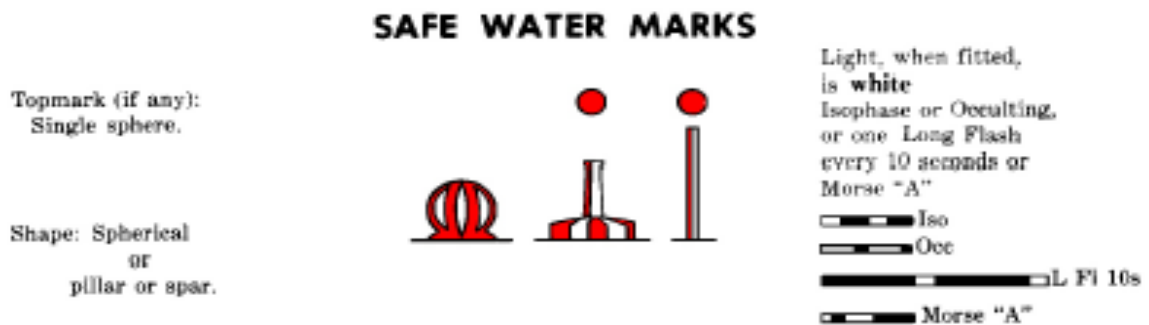

Remarks:

- If it is required to encode a beacon that has more than one colour, the attributes **colour** and **colour pattern** must be encoded, according to the rules laid out in clause X.X.
- For guidance on the encoding of the attributes **elevation**, **height** and **vertical length** see clause X.X. **Elevation** applies only to beacons on land. Values populated for **height** and **vertical length** must include the topmark and any equipment features.
- If it is required to encode a cairn that bears the colour(s) specified by a navigational system of marks, it must be done using a beacon feature.

Distinction: Beacon cardinal; beacon isolated danger; beacon lateral; beacon special purpose/general; daymark.

Feature/Information associations							
Type	Association Name	Association Ends					
		Class	Role	Mult	Class	Role	Mult
Comp	Structure/Equipment	Beacon Safe Water	Supported by	0,1	Daymark, Fog Signal, Light All Around, Light Fog Detector, Light Sectored, Physical AIS Aid to Navigation, Radar Transponder Beacon, Retroreflector, Signal Station Traffic, Signal Station Warning	Supports	1,*
Aggr	Range System Aggregation	Beacon Safe Water	Consists of	1,*	Range System	Component of	0,1
Asso	Aids to Navigation Association	Beacon Safe Water	Consists of	1,*	Archipelagic Sea Lane, Deep Water Route, Fairway System, Traffic Separation Scheme, Two-Way Route	Component of	0,1

20.12 Special purpose/general beacons

IHO Definition: BEACON SPECIAL PURPOSE/GENERAL. A beacon is a prominent specially constructed object forming a conspicuous mark as a fixed aid to navigation or for use in hydrographic survey. (IHO Dictionary – S-32).

A special purpose beacon is primarily used to indicate an area or feature, the nature of which is apparent from reference to a chart, Sailing Directions or Notices to Mariners. (UKHO NP 735, 5th Edition).

S-101 Geo Feature: Beacon special purpose/general (BCNSPP)

Primitives: Point

<i>Real World</i>	<i>Paper Chart Symbol</i>	<i>ECDIS Symbol</i>
-------------------	---------------------------	---------------------

S-101 Attribute	S-57 Acronym	Allowable Encoding Value	Type	Multiplicity
Beacon shape	(BCNSHP)	1 : stake, pole, perch, post 2 : withy 3 : beacon tower 5 : pile beacon 6 : cairn 7 : buoyant beacon	EN	1,1
Category of special purpose mark	(CATSPM)	1 : firing danger area mark 2 : target mark 3 : marker ship mark 4 : degaussing range mark 5 : barge mark 6 : cable mark 7 : spoil ground mark 8 : outfall mark 10 : recording mark 11 : seaplane anchorage mark 12 : recreation zone mark 14 : mooring mark 16 : leading mark 17 : measured distance mark 18 : notice mark 19 : TSS mark (Traffic Separation Scheme) 20 : anchoring prohibited mark 21 : berthing prohibited mark 22 : overtaking prohibited mark 23 : two-way traffic prohibited mark 24 : reduced wake mark 25 : speed limit mark 26 : stop mark 27 : general warning mark 28 : sound ship's siren mark 29 : restricted vertical clearance mark 30 : maximum vessel's draught mark 31 : restricted horizontal clearance mark	EN	1,*

		32 : strong current warning mark 33 : berthing permitted mark 34 : overhead power cable mark 35 : channel edge gradient mark 36 : telephone mark 37 : ferry crossing mark 39 : pipeline mark 40 : anchorage mark 41 : clearing mark 42 : control mark 43 : diving mark 44 : refuge beacon 45 : foul ground mark 46 : yachting mark 47 : heliport mark 48 : GNSS mark 49 : seaplane landing mark 50 : entry prohibited mark 51 : work in progress mark 52 : mark with unknown purpose 53 : wellhead mark 54 : channel separation mark 55 : marine farm mark 56 : artificial reef mark 57 : ice mark 58 : nature reserve mark 60 : wreck mark 61 : customs mark 62 : causeway mark 63 : wave recorder		
Colour	(COLOUR)	1 : white 2 : black 3 : red 4 : green 5 : blue 6 : yellow 7 : grey 8 : brown 9 : amber 10 : violet 11 : orange 12 : magenta 13 : pink	EN	1,* (ordered)
Colour pattern	(COLPAT)	1 : horizontal stripes 2 : vertical stripes 3 : diagonal stripes 4 : squared 5 : stripes (direction unknown) 6 : border stripe	EN	0,1
Condition	(CONDTN)	1 : under construction 2 : ruined 5 : planned construction	EN	0,1
Elevation	(ELEVAT)		RE	0,1
Feature name			C	0,*
Display name			(S) BO	0,1
Language		ISO 639-3	(S) TE	0,1

Name	(<i>OBJNAM</i>) (<i>NOBJNM</i>)		(S) TE	1,1
Fixed date range			C	0,1
Date end	(DATEND)	ISO 8601: 2004	(S) TD	0,1
Date start	(DATSTA)	ISO 8601: 2004	(S) TD	0,1
Height	(HEIGHT)		RE	0,1
Marks navigational – system of	(MARSYS)	1 : IALA A 2 : IALA B 9 : no system 11 : CEVNI	EN	0,1
Nature of construction	(NATCON)	1 : masonry 2 : concreted 6 : wooden 7 : metal 8 : glass reinforced plastic (GRP) 11 : latticed	EN	0,*
Periodic date range			C	0,*
Date end	(<i>PEREND</i>)	ISO 8601: 2004	(S) TD	1,1
Date start	(<i>PERSTA</i>)	ISO 8601: 2004	(S) TD	1,1
Radar conspicuous	(CONRAD)		BO	0,1
Reported date	(<i>SORDAT</i>)	ISO 8601: 2004	TD	0,1
Status	(STATUS)	1 : permanent 2 : occasional 4 : not in use 5 : periodic/intermittent 7 : temporary 8 : private 12 : illuminated 18 : existence doubtful	EN	0,*
Topmark	(<i>TOPMAR</i>)		C	0,1
Colour	(COLOUR)	1 : white 2 : black 3 : red 4 : green 5 : blue 6 : yellow 7 : grey 8 : brown 9 : amber 10 : violet 11 : orange 12 : magenta 13 : pink	(S) EN	0,1
Topmark/daymark shape	(TOPSHP)	1 : cone, point up 2 : cone, point down 3 : sphere 4 : 2 spheres 5 : cylinder (can) 6 : board 7 : x-shape (St. Andrew's cross) 8 : upright cross (St George's cross) 9 : cube, point up 10 : 2 cones, point to point 11 : 2 cones, base to base	(S) EN	1,1

		12 : rhombus (diamond) 13 : 2 cones (points upward) 14 : 2 cones (points downward) 15 : besom, point up (broom or perch) 16 : besom, point down (broom or perch) 17 : flag 18 : sphere over rhombus 19 : square 20 : rectangle, horizontal 21 : rectangle, vertical 22 : trapezium, up 23 : trapezium, down 24 : triangle, point up 25 : triangle, point down 26 : circle 27 : two upright crosses (one over the other) 28 : T-shape 29 : triangle pointing up over a circle 30 : upright cross over a circle 31 : rhombus over a circle 32 : circle over a triangle pointing up 33 : other shape (see shape information)		
Shape information			(S) C	0,*
Language		ISO 639-3	(S) TE	0,1
Text	(INFORM) (NINFOM)		(S) TE	1,1
Vertical length	(VERLEN)		RE	0,1
Visually conspicuous	(CONVIS)	1 : visually conspicuous 2 : not visually conspicuous 3 : prominent	EN	0,1
Scale minimum	(SCAMIN)	See clause X.X	IN	0,1

INT 1 Reference: Q 130.6

20.12.1 Special purpose/general beacons (see S-4 – B-461.3 and B-467)

Special beacons are used to indicate to the mariner a special area or feature, the nature of which is usually apparent from the chart or associated publication.

To conform to the IALA Maritime Buoyage System (see clause X.X), the body of the beacon is yellow. The topmark (if fitted) is a yellow diagonal 'X' (St Andrew's cross). Lights (if fitted) are yellow and of any rhythm except those used for cardinal, isolated danger and safe water marks.

If it is required to encode a beacon having the function of a special purpose mark, or a beacon whose appearance or purpose is inadequately known, it must be done using the feature **Beacon Special Purpose/General**.

In the following table, a blank indicates that the encoder may choose a relevant value for the attribute. The table contains the most common examples of coding; other coding combinations are possible.

Feature	INT1	Feature	beacon shape	category of special purpose mark	Other attributes
Minor not permanent mark	Q90	Beacon ***	1		

Cairn	Q100	Beacon ***	6		
Beacon tower	Q110	Beacon ***	3		
Lattice beacon	Q111	Beacon ***			nature of construction = 10
Leading beacon	Q120	Beacon Special Purpose/General		16	
Beacon marking a clearing line	Q121	Beacon Special Purpose/General		41	
Beacon marking measured distance	Q122	Beacon Special Purpose/General		17	
Cable landing beacon	Q123	Beacon Special Purpose/General		6	
Outfall landing beacon	Q123	Beacon Special Purpose/General		8	
Pipeline landing beacon	Q123	Beacon Special Purpose/General		39	
Refuge beacon	Q124	Beacon Special Purpose/General		44	
Firing practice area beacon	Q125	Beacon Special Purpose/General		1	
Notice board	Q126	Beacon Special Purpose/General		18	
Buoyant beacon	P5	Beacon Special Purpose/General	7		

Remarks:

- If it is required to encode a beacon that has more than one colour, the attributes **colour** and **colour pattern** must be encoded, according to the rules laid out in clause X.X.
- For guidance on the encoding of the attributes **elevation**, **height** and **vertical length** see clause X.X. **Elevation** applies only to beacons on land. Values populated for **height** and **vertical length** must include the topmark and any equipment features.
- If a special purpose beacon does not conform to the system of navigational marks defined by **Navigational System of Marks** (see clause X.X), the attribute **marks navigational – system of** on the **Beacon Special Purpose/General** should be populated as 9 (no system).
- If it is required to encode a cairn that bears the colour(s) specified by a navigational system of marks, it must be done using a beacon feature.

20.12.2 Signs and notice boards

If it is required to encode a fixed or floating sign or notice board, it must be done using a **Beacon Special Purpose/General** feature or **Buoy Special Purpose/General** feature (see clause X.X), with attribute **category of special purpose mark = 18** (notice mark), or using the feature **Daymark** (see clause X.X).

Remarks:

- If it is required to encode a sign or notice board that has more than one colour, the attributes **colour** and **colour pattern** must be used, according to the rules laid out in clause X.X.
- If it is required to encode any text shown on a notice board or sign, it must be done using an associated instance of the information class **Nautical Information** (see clause X.X), complex attribute **information**.
- If it is required to encode the shape and colour of a notice board, it must be done by encoding the board as a **Daymark** feature.

Distinction: Beacon cardinal; beacon isolated danger; beacon lateral; beacon safe water; daymark.

Feature/Information associations							
Type	Association Name	Association Ends					
		Class	Role	Mult	Class	Role	Mult

Comp	Structure/Equipment	Beacon Special Purpose/General	Supported by	0,1	Daymark, Fog Signal, Light All Around, Light Fog Detector, Light Sectored, Physical AIS Aid to Navigation, Radar Transponder Beacon, Retroreflector, Signal Station Traffic, Signal Station Warning	Supports	1,*
Aggr	Range System Aggregation	Beacon Special Purpose/General	Consists of	1,*	Range System	Component of	0,1
Asso	Aids to Navigation Association	Beacon Special Purpose/General	Consists of	1,*	Archipelagic Sea Lane, Deep Water Route, Fairway System, Traffic Separation Scheme, Two-Way Route	Component of	0,1

20.13 Daymarks

IHO Definition: DAYMARK. The identifying characteristics of an aid to navigation which serve to facilitate its recognition against a daylight viewing background. On those structures that do not by themselves present an adequate viewing area to be seen at the required distance, the aid is made more visible by affixing a daymark to the structure. A daymark so affixed has a distinctive colour and shape depending on the purpose of the aid. (IHO Dictionary – S-32, Edition 5).

S-101 Geo Feature: Daymark (DAYMAR)

Primitives: Point

Real World

Paper Chart Symbol

ECDIS Symbol

S-101 Attribute	S-57 Acronym	Allowable Encoding Value	Type	Multiplicity
Category of special purpose mark	(CATSPM)	1 : firing danger area mark 2 : target mark 3 : marker ship mark 4 : degaussing range mark 5 : barge mark 6 : cable mark 7 : spoil ground mark 8 : outfall mark 10 : recording mark 11 : seaplane anchorage mark 12 : recreation zone mark 14 : mooring mark 15 : LANBY (Large Automatic Navigational Buoy) 16 : leading mark 17 : measured distance mark 18 : notice mark 19 : TSS mark (Traffic Separation Scheme) 20 : anchoring prohibited mark 21 : berthing prohibited mark 22 : overtaking prohibited mark 23 : two-way traffic prohibited mark 24 : reduced wake mark 25 : speed limit mark 26 : stop mark 27 : general warning mark 28 : sound ship's siren mark 29 : restricted vertical clearance mark 30 : maximum vessel's draught mark 31 : restricted horizontal clearance mark 32 : strong current warning mark 33 : berthing permitted mark 34 : overhead power cable mark	EN	0,*

		35 : channel edge gradient mark 36 : telephone mark 37 : ferry crossing mark 39 : pipeline mark 40 : anchorage mark 41 : clearing mark 42 : control mark 43 : diving mark 44 : refuge beacon 45 : foul ground mark 46 : yachting mark 47 : heliport mark 48 : GNSS mark 49 : seaplane landing mark 50 : entry prohibited mark 51 : work in progress mark 52 : mark with unknown purpose 53 : wellhead mark 54 : channel separation mark 55 : marine farm mark 56 : artificial reef mark 57 : ice mark 58 : nature reserve mark 60 : wreck mark 61 : customs mark 62 : causeway mark 63 : wave recorder		
Colour	(COLOUR)	1 : white 2 : black 3 : red 4 : green 5 : blue 6 : yellow 7 : grey 8 : brown 9 : amber 10 : violet 11 : orange 12 : magenta 13 : pink	EN	1,* (ordered)
Colour pattern	(COLPAT)	1 : horizontal stripes 2 : vertical stripes 3 : diagonal stripes 4 : squared 5 : stripes (direction unknown) 6 : border stripe	EN	0,1
Elevation	(ELEVAT)		RE	0,1
Feature name			C	0,* (ordered)
Display name			(S) BO	0,1
Language		ISO 639-3	(S) TE	0,1
Name	(OBJNAM) (NOBJNM)		(S) TE	1,1
Fixed date range			C	0,1
Date end	(DATEND)	ISO 8601: 2004	(S) TD	0,1
Date start	(DATSTA)	ISO 8601: 2004	(S) TD	0,1
Height	(HEIGHT)		RE	0,1

Nature of construction	(NATCON)	1 : masonry 2 : concreted 4 : hard surfaced 6 : wooden 7 : metal 8 : glass reinforced plastic (GRP) 11 : latticed	EN	0,*
Periodic date range			C	0,*
Date end	(PEREND)	ISO 8601: 2004	(S) TD	1,1
Date start	(PERSTA)	ISO 8601: 2004	(S) TD	1,1
Radar conspicuous	(CONRAD)		BO	0,1
Status	(STATUS)	1 : permanent 4 : not in use 5 : periodic/intermittent 7 : temporary 8 : private 12: illuminated	EN	0,*
Topmark/daymark shape	(TOPSHP)	1 : cone, point up 2 : cone, point down 3 : sphere 4 : 2 spheres 5 : cylinder (can) 6 : board 7 : x-shape (St. Andrew's cross) 8 : upright cross (St George's cross) 9 : cube, point up 10 : 2 cones, point to point 11 : 2 cones, base to base 12 : rhombus (diamond) 13 : 2 cones (points upward) 14 : 2 cones (points downward) 15 : besom, point up (broom or perch) 16 : besom, point down (broom or perch) 17 : flag 18 : sphere over rhombus 19 : square 20 : rectangle, horizontal 21 : rectangle, vertical 22 : trapezium, up 23 : trapezium, down 24 : triangle, point up 25 : triangle, point down 26 : circle 27 : two upright crosses (one over the other) 28 : T-shape 29 : triangle pointing up over a circle 30 : upright cross over a circle 31 : rhombus over a circle 32 : circle over a triangle pointing up 33 : other shape (see shape information)	EN	1,1
Vertical length	(VERLEN)		RE	0,1

Shape information			C	0,*
Language		ISO 639-3	(S) TE	0,1
Text	(INFORM) (NINFOM)		(S) TE	1,1
Scale minimum	(SCAMIN)	See clause X.X	IN	0,1

INT 1 Reference: Q 101

20.13.1 Daymarks (see S-4 – B-455.9)

If it is required to encode a daymark, it must be done using the feature **Daymark**.

The term “daymark” may also simply refer to any unlighted aid to navigation, particularly for leading marks (see clause X.X). In North America, the term “daybeacon” is used for an unlit beacon.

In the following table, a blank indicates that the encoder may choose a relevant value for the attribute. The table contains the most common examples of coding; other coding combinations are possible.

Feature	INT1	Feature	category of special purpose mark	Other attributes
Coloured or white mark	Q101	Daymark		nature of construction = 9
Coloured topmark with function of beacon	Q102.1	Daymark		nature of construction = 9
Painted board with function of leading beacon	Q102.2	Daymark	16	topmark shape = 6

Remarks:

- For guidance on the encoding of the attributes **elevation**, **height** and **vertical length** see clause X.X. **Elevation** applies only to daymarks on land. Values populated for **height** and **vertical length** must include any equipment features.
- If it is required to encode a cairn that bears the colour(s) specified by a navigational system of marks, it must be done using a beacon feature.
- If it is required to encode a daymark that has more than one colour, the attributes **colour** and **colour pattern** must be encoded, according to the rules laid out in clause X.X.

Distinction: Beacon cardinal; beacon isolated danger; beacon lateral; beacon safe water; beacon special purpose/general; topmark.

Feature/Information associations							
Type	Association Name	Association Ends					
		Class	Role	Mult	Class	Role	Mult
Comp	Structure/Equipment	Daymark	Supported by	0,1	Fog Signal, Light All Around, Light Fog Detector, Light Sectored, Physical AIS Aid to Navigation, Radar Transponder Beacon, Retroreflector, Signal Station Traffic, Signal Station Warning	Supports	1,*
Comp	Structure/Equipment	Daymark	Supports	1,1	Beacon Cardinal, Beacon Isolated Danger, Beacon Lateral, Beacon Safe Water, Beacon Special	Supported by	0,1

					Purpose/General, Bridge, Building, Buoy Cardinal, Buoy Emergency Wreck Marking, Buoy Installation, Buoy Isolated Danger, Buoy Lateral, Buoy Safe Water, Buoy Special Purpose/General, Crane, Conveyor, Fishing Facility, Floating Dock, Fortified Structure, Hulk, Landmark, Light Float, Light Vessel, Mooring/Warping Facility, Offshore Platform, Pile, Pipeline Overhead, Pontoon, Pylon/Bridge Support, Shoreline Construction, Silo/Tank, Span Fixed, Span Opening, Wind Turbine		
Aggr	Range System Aggregation	Daymark	Consists of	1,*	Range System	Component of	0,1
Asso	Aids to Navigation Association	Daymark	Consists of	1,*	Archipelagic Sea Lane, Deep Water Route, Fairway System, Traffic Separation Scheme, Two-Way Route	Component of	0,1

20.14 Light floats

IHO Definition: **LIGHT FLOAT.** A boat-like structure used instead of a light buoy in waters where strong streams or currents are experienced, or when a greater elevation than that of a light buoy is necessary. (IHO Dictionary – S-32).

S-101 Geo Feature: Light float (LITFLT)

Primitives: Point

<i>Real World</i>	<i>Paper Chart Symbol</i>	<i>ECDIS Symbol</i>
-------------------	---------------------------	---------------------

S-101 Attribute	S-57 Acronym	Allowable Encoding Value	Type	Multiplicity
Colour	(COLOUR)	1 : white 2 : black 3 : red 4 : green 5 : blue 6 : yellow 7 : grey 8 : brown 9 : amber 10 : violet 11 : orange 12 : magenta 13 : pink	EN	1,* (ordered)
Colour pattern	(COLPAT)	1 : horizontal stripes 2 : vertical stripes 3 : diagonal stripes 4 : squared 5 : stripes (direction unknown) 6 : border stripe	EN	0,1
Feature name			C	0,*
Display name			(S) BO	0,1
Language		ISO 639-3	(S) TE	0,1
Name	(OBJNAM) (NOBJNM)		(S) TE	1,1
Fixed date range			C	0,1
Date end	(DATEND)	ISO 8601: 2004	(S) TD	0,1
Date start	(DATSTA)	ISO 8601: 2004	(S) TD	0,1
Horizontal length	(HORLEN)		RE	0,1
Horizontal width	(HORWID)		RE	0,1
Nature of construction	(NATCON)	6 : wooden 7 : metal 11 : latticed	EN	0,*
Periodic date range			C	0,*
Date end	(PEREND)	ISO 8601: 2004	(S) TD	1,1
Date start	(PERSTA)	ISO 8601: 2004	(S) TD	1,1
Radar conspicuous	(CONRAD)		BO	0,1

Status	(STATUS)	1 : permanent 2 : occasional 4 : not in use 5 : periodic/intermittent 7 : temporary 8 : private 14 : public 16 : watched 17 : un-watched	EN	0,*
Topmark	(<i>TOPMAR</i>)		C	0,1
Colour	(COLOUR)	1 : white 2 : black 3 : red 4 : green 5 : blue 6 : yellow 7 : grey 8 : brown 9 : amber 10 : violet 11 : orange 12 : magenta 13 : pink	(S) EN	0,1
Topmark/daymark shape	(TOPSHP)	1 : cone, point up 2 : cone, point down 3 : sphere 4 : 2 spheres 5 : cylinder (can) 6 : board 7 : x-shape (St. Andrew's cross) 8 : upright cross (St George's cross) 9 : cube, point up 10 : 2 cones, point to point 11 : 2 cones, base to base 12 : rhombus (diamond) 13 : 2 cones (points upward) 14 : 2 cones (points downward) 15 : besom, point up (broom or perch) 16 : besom, point down (broom or perch) 17 : flag 18 : sphere over rhombus 19 : square 20 : rectangle, horizontal 21 : rectangle, vertical 22 : trapezium, up 23 : trapezium, down 24 : triangle, point up 25 : triangle, point down 26 : circle 27 : two upright crosses (one over the other) 28 : T-shape 29 : triangle pointing up over a circle 30 : upright cross over a circle 31 : rhombus over a circle 32 : circle over a triangle pointing up 33 : other shape (see shape)	(S) EN	1,1

		information)		
Shape information			(S) C	0,*
Language		ISO 639-3	(S) TE	0,1
Text	(INFORM) (NINFOM)		(S) TE	1,1
Vertical length	(VERLEN)		RE	0,1
Visually conspicuous	(CONVIS)	1 : visually conspicuous 2 : not visually conspicuous 3 : prominent	EN	0,1
Scale minimum	(SCAMIN)	See clause X.X	IN	0,1

INT 1 Reference: Q 30

20.14.1 Lights floats (see S-4 – B-462.8)

If it is required to encode a light float, it must be done using the feature **Light Float**.

Remarks:

- If it is required to encode a light float or topmark that has more than one colour, the attributes **colour** and **colour pattern** must be encoded, according to the rules laid out in clause X.X.
- The light on a light float is a separate feature, handled as with buoys, beacons, etc.

Distinction: Buoy cardinal; buoy emergency wreck marking; buoy installation; buoy isolated danger; buoy lateral; buoy safe water; buoy special purpose/general; light vessel.

Feature/Information associations							
Type	Association Name	Association Ends					
		Class	Role	Mult	Class	Role	Mult
Comp	Structure/Equipment	Light Float	Supported by	0,1	Daymark, Fog Signal, Light All Around, Light Fog Detector, Physical AIS Aid to Navigation, Radar Transponder Beacon, Retroreflector, Signal Station Traffic, Signal Station Warning	Supports	1,*
Asso	Aids to Navigation Association	Light Float	Consists of	1,*	Archipelagic Sea Lane, Deep Water Route, Fairway System, Traffic Separation Scheme, Two-Way Route	Component of	0,1

20.15 Light vessels

IHO Definition: **LIGHT VESSEL.** A distinctively marked vessel anchored or moored at a charted point, to serve as an aid to navigation. By night, it displays a characteristic light(s) and is usually equipped with other devices, such as fog signal, submarine sound signal, and radio-beacon, to assist navigation. Also called light ship. (IHO Dictionary – S-32).

S-101 Geo Feature: Light vessel (LITVES)

Primitives: Point

Real World

Paper Chart Symbol

ECDIS Symbol

S-101 Attribute	S-57 Acronym	Allowable Encoding Value	Type	Multiplicity
Colour	(COLOUR)	1 : white 2 : black 3 : red 4 : green 5 : blue 6 : yellow 7 : grey 8 : brown 9 : amber 10 : violet 11 : orange 12 : magenta 13 : pink	EN	1,* (ordered)
Colour pattern	(COLPAT)	1 : horizontal stripes 2 : vertical stripes 3 : diagonal stripes 4 : squared 5 : stripes (direction unknown) 6 : border stripe	EN	0,1
Feature name			C	0,*
Display name			(S) BO	0,1
Language		ISO 639-3	(S) TE	0,1
Name	(OBJNAM) (NOBJNM)		(S) TE	1,1
Fixed date range			C	0,1
Date end	(DATEND)	ISO 8601: 2004	(S) TD	0,1
Date start	(DATSTA)	ISO 8601: 2004	(S) TD	0,1
Horizontal length	(HORLEN)		RE	0,1
Horizontal width	(HORWID)		RE	0,1
Nature of construction	(NATCON)	6 : wooden 7 : metal	EN	0,*
Periodic date range			C	0,*
Date end	(PEREND)	ISO 8601: 2004	(S) TD	1,1
Date start	(PERSTA)	ISO 8601: 2004	(S) TD	1,1
Radar conspicuous	(CONRAD)		BO	0,1

Status	(STATUS)	1 : permanent 2 : occasional 4 : not in use 5 : periodic/intermittent 7 : temporary 8 : private 14 : public 16 : watched 17 : un-watched	EN	0,*
Vertical length	(VERLEN)		RE	0,1
Visually conspicuous	(CONVIS)	1 : visually conspicuous 2 : not visually conspicuous 3 : prominent	EN	0,1
Scale minimum	(SCAMIN)	See clause X.X	IN	0,1

INT 1 Reference: P 6

20.15.1 Lights vessels (see S-4 – B-474.1-3)

Major floating lights are generally classed as those with a nominal range in excess of 10 nautical miles. Special circumstances, for example an isolated location, may mean that a floating light of lower range is given this status. The structure on which the light is fixed will be a light vessel, a major light float or a LANBY (Large Automatic Navigational Buoy, which is a type of superbuoy).

If it is required to encode a light vessel, it must be done using the feature **Light Vessel**.

Remarks:

- If it is required to encode a light vessel that has more than one colour, the attributes **colour** and **colour pattern** must be encoded, according to the rules laid out in clause X.X.

Distinction: Beacon cardinal; beacon isolated danger; beacon lateral; beacon safe water; beacon special purpose/general; buoy cardinal; buoy emergency wreck marking; buoy installation; buoy isolated danger; buoy lateral; buoy safe water; buoy special purpose/general; light float.

<u>Feature/Information associations</u>							
Type	Association Name	Association Ends					
		Class	Role	Mult	Class	Role	Mult
Comp	Structure/Equipment	Light Vessel	Supported by	0,1	Daymark, Fog Signal, Light All Around, Light Fog Detector, Physical AIS Aid to Navigation, Radar Transponder Beacon, Retroreflector, Signal Station Traffic, Signal Station Warning	Supports	1,*
Asso	Aids to Navigation Association	Light Vessel	Consists of	1,*	Archipelagic Sea Lane, Deep Water Route, Fairway System, Traffic Separation Scheme, Two-Way Route	Component of	0,1

20.16 Retroreflectors

IHO Definition: **RETROREFLECTOR.** A means of distinguishing unlighted marks at night. Retroreflective material is secured to the mark in a particular pattern to reflect back light. (UKHO NP 735, 5th Edition).

S-101 Geo Feature: Retroreflector (RETRFL)

Primitives: Point

Real World

Paper Chart Symbol

ECDIS Symbol

S-101 Attribute	S-57 Acronym	Allowable Encoding Value	Type	Multiplicity
Colour	(COLOUR)	1 : white 2 : black 3 : red 4 : green 5 : blue 6 : yellow 7 : grey 8 : brown 9 : amber 10 : violet 11 : orange 12 : magenta 13 : pink	EN	0,* (ordered)
Colour pattern	(COLPAT)	1 : horizontal stripes 2 : vertical stripes 3 : diagonal stripes 4 : squared 5 : stripes (direction unknown) 6 : border stripe	EN	0,1
Fixed date range			C	0,1
Date end	(DATEND)	ISO 8601: 2004	(S) TD	0,1
Date start	(DATSTA)	ISO 8601: 2004	(S) TD	0,1
Height	(HEIGHT)		RE	0,1
Periodic date range			C	0,*
Date end	(PEREND)	ISO 8601: 2004	(S) TD	1,1
Date start	(PERSTA)	ISO 8601: 2004	(S) TD	1,1
Status	(STATUS)	1 : permanent 4 : not in use 8 : private	EN	0,*
Scale minimum	(SCAMIN)	See clause X.X	IN	0,1

INT 1 Reference: Q 6

20.16.1 Retroreflectors (see S-4 – B-460.7)

Retroreflective material may be secured to unlit marks to aid their identification at night. The material is coloured according to one of two recognized IALA codes (“Standard” and “Comprehensive”). In any specified area only one of the codes will be used and this may be given in nautical publications.

If it is required to encode a retroreflector, it must be done using the feature **Retroreflector**.

Remarks:

- An associated instance of the information class **Nautical Information** (see clause X.X) may be used to describe letters, patterns or numerals shown on the retroreflector.
- The body carrying the retroreflector is a separate feature.

Distinction: Beacon cardinal; beacon isolated danger; beacon lateral; beacon safe water; beacon special purpose/general; buoy cardinal; buoy emergency wreck marking; buoy installation; buoy isolated danger; buoy lateral; buoy safe water; buoy special purpose/general; radar reflector.

Feature/Information associations							
Type	Association Name	Association Ends					
		Class	Role	Mult	Class	Role	Mult
Comp	Structure/Equipment	Retroreflector	Supports	0,1	Beacon Cardinal, Beacon Isolated Danger, Beacon Lateral, Beacon Safe Water, Beacon Special Purpose/General, Bridge, Building, Buoy Cardinal, Buoy Emergency Wreck Marking, Buoy Installation, Buoy Isolated Danger, Buoy Lateral, Buoy Safe Water, Buoy Special Purpose/General, Crane, Conveyor, Daymark, Fishing Facility, Floating Dock, Fortified Structure, Hulk, Landmark, Light All Around, Light Sector, Light Float, Light Vessel, Mooring/Warping Facility, Offshore Platform, Pile, Pipeline Overhead, Pontoon, Pylon/Bridge Support, Shoreline Construction, Silo/Tank, Span Fixed, Span Opening, Wind Turbine	Supported by	1,1

20.17 Radar reflectors

IHO Definition: **RADAR REFLECTOR**. A device capable of, or intended for, reflecting radar signals. (IHO Dictionary – S-32).

A radar reflector is usually a “tetrahedron or pentagonal corner reflector (...) to facilitate reflection towards the sender”. (International Maritime Dictionary, 2nd Ed.).

S-101 Geo Feature: Radar reflector (RADRFL)

Primitives: Point

Real World

Paper Chart Symbol

ECDIS Symbol

S-101 Attribute	S-57 Acronym	Allowable Encoding Value	Type	Multiplicity
Fixed date range			C	0,1
Date end	(DATEND)	ISO 8601: 2004	(S) TD	0,1
Date start	(DATSTA)	ISO 8601: 2004	(S) TD	0,1
Height	(HEIGHT)		RE	0,1
Periodic date range			C	0,*
Date end	(PEREND)	ISO 8601: 2004	(S) TD	1,1
Date start	(PERSTA)	ISO 8601: 2004	(S) TD	1,1
Status	(STATUS)	1 : permanent 4 : not in use 8 : private	EN	0,*
Scale minimum	(SCAMIN)	See clause X.X	IN	0,1

INT 1 Reference: S 4

20.17.1 Radar reflectors (see S-4 – B-455.8 and B-465)

If it is required to encode radar reflectors on curve features (for instance overhead cables, overhead pipelines, conveyors), this must be done using the feature **Radar Reflector**.

Remarks:

- If it is required to encode a feature which has no radar reflector, but is radar conspicuous, it must be indicated using attribute **radar conspicuous** on the feature.
- If it is required to encode a surface or point feature which is radar conspicuous because it is fitted with a radar reflector, it must be indicated using **radar conspicuous** on the feature. A **Radar Reflector** feature must not be encoded in this case.

Distinction: Retro-reflector.

Feature/Information associations							
Type	Association Name	Association Ends					
		Class	Role	Mult	Class	Role	Mult
Comp	Structure/Equipment	Radar Reflector	Supports	1,*	Cable Overhead	Supported by	0,1

20.18 Fog signals

IHO Definition: FOG SIGNALS. A warning signal transmitted by a vessel, or aid to navigation, during periods of low visibility. Also, the device producing such a signal. (IHO Dictionary – S-32).

S-101 Geo Feature: Fog signal (FOGSIG)

Primitives: Point

Real World

Paper Chart Symbol

ECDIS Symbol

S-101 Attribute	S-57 Acronym	Allowable Encoding Value	Type	Multiplicity
Category of fog signal	(CATFOG)	1 : explosive 2 : diaphone 3 : siren 4 : nautophone 5 : reed 6 : tyfon 7 : bell 8 : whistle 9 : gong 10 : horn	EN	1,1
Feature name			C	0,*
Display name			(S) BO	0,1
Language		ISO 639-3	(S) TE	0,1
Name	(OBJNAM) (NOBJNM)		(S) TE	1,1
Fixed date range			C	0,1
Date end	(DATEND)	ISO 8601: 2004	(S) TD	0,1
Date start	(DATSTA)	ISO 8601: 2004	(S) TD	0,1
Periodic date range			C	0,*
Date end	(PEREND)	ISO 8601: 2004	(S) TD	1,1
Date start	(PERSTA)	ISO 8601: 2004	(S) TD	1,1
Signal frequency	(SIGFRQ)		IN	0,1
Signal generation	(SIGGEN)	1 : automatically 2 : by wave action 3 : by hand 4 : by wind 5 : radio activated 6 : call activated	EN	0,1
Signal group	(SIGGRP)		TE	0,1
Signal period	(SIGPER)		RE	0,1
Signal sequence	(SIGSEQ)		C	0,* (ordered)
Signal duration			(S) RE	1,1
Signal status		1 : lit/sound 2 : eclipsed/silent	(S) EN	1,1
Status	(STATUS)	1 : permanent 2 : occasional 4 : not in use	EN	0,*

		5 : periodic/intermittent 7 : temporary 8 : private 15 : synchronized		
Value of maximum range	(VALMXR)		RE	0,1
Scale minimum	(SCAMIN)	See clause X.X	IN	0,1

INT 1 Reference: R 1, 10-16, 20-22

20.18.1 Fog signals (see S-4 – B-451-454)

The term “fog signal” refers to the sound emitted, not the apparatus. Fog signals are short range aids to navigation, principally used as hazard warnings. For various reasons they are unreliable as indicators of position. Their importance relative to other aids to navigation has declined but they are still considered useful for the safe navigation of vessels with very limited (or non-functioning) electronic equipment. A fog signal should be shown on ENC’s at an maximum display scale on which vessels may navigate within range.

The position from which a fog signal is emitted is usually on a buoy, or close enough to a light to be treated as sounded from the same position as the light.

If it is required to encode a fog signal, it must be done using the feature **Fog Signal**.

Remarks:

- The characteristic rhythm of fog signals (other than those actuated by waves, which are irregular) may be more important than their type when mariners are attempting to identify them. The number of sound emissions (for example blasts, strokes) and the period must therefore be encoded, where known, using the attributes **signal group**, **signal period** and **signal sequence**.
- Where required, the attribute **signal frequency** must be quoted in Hertz, for example a signal frequency of 950 MHz must be encoded as *950000000*.
- If the fog signal is radio activated, the attribute **signal generation** must be populated with value 5 (radio activated). To encode the contact information for activation of the signal, it must be done using the information class **Contact Details** (see clause X.X). The **Contact Details** must be associated to the **Fog Signal** feature using the association **additional information**.
- If the fog signal is activated by calling into a manned station, the attribute **signal generation** must be populated with value 6 (call activated). To encode the contact information for the manned station, it must be done using the information class **Contact Details**. The **Contact Details** must be associated to the **Fog Signal** feature using the association **additional information**.

Distinction: Signal station, warning.

Feature/Information associations

Type	Association Name	Association Ends					
		Class	Role	Mult	Class	Role	Mult
Comp	Structure/Equipment	Fog Signal	Supports	1,1	Beacon Cardinal, Beacon Isolated Danger, Beacon Lateral, Beacon Safe Water, Beacon Special Purpose/General, Bridge, Building, Buoy Cardinal, Buoy Emergency Wreck Marking, Buoy Installation, Buoy Isolated Danger, Buoy Lateral, Buoy Safe Water, Buoy Special Purpose/General, Crane, Conveyor, Daymark, Fishing Facility, Floating	Supported by	0,1

					Dock, Fortified Structure, Hulk, Landmark, Light Float, Light Vessel, Mooring/Warping Facility, Offshore Platform, Pile, Pipeline Overhead, Pontoon, Pylon/Bridge Support, Shoreline Construction, Silo/Tank, Span Fixed, Span Opening, Wind Turbine		
Asso	Additional Information	Fog Signal	Provides information	1,*	Contact Details	Information provided for	0,1

21 Geo Features – Radar, Radio

21.1 Automatic Identification System (AIS) aids to navigation (see S-4 – B-480-484)

AIS signals used as an aid to navigation may:

- actually be transmitted from a physical aid to navigation, or appear to be transmitted from a physical aid to navigation but is actually transmitted from an AIS base station (Physical AIS aid to navigation);
- be transmitted from an AIS base station to represent an aid to navigation where a physical aid to navigation does not exist (Virtual AIS aid to navigation).

21.2 Physical AIS aid to navigation

IHO Definition: AIS AID TO NAVIGATION. An Automatic Identification System (AIS) message 21 transmitted from a physical Aid to Navigation, or transmitted from an AIS station for an Aid to Navigation which does or does not physically exist. (Adapted from IALA Recommendation A-126).

S-101 Geo Feature: Physical AIS aid to navigation

Primitives: Point

Real World

Paper Chart Symbol

ECDIS Symbol

S-101 Attribute	S-57 Acronym	Allowable Encoding Value	Type	Multiplicity
Estimated range of transmission	(ESTRNG)		RE	0,1
Feature name			C	0,*
Display name			(S) BO	0,1
Language		ISO 639-3	(S) TE	0,1
Name	(OBJNAM) (NOBJNM)		(S) TE	1,1
Fixed date range			C	0,1
Date end	(DATEND)	ISO 8601: 2004	(S) TD	0,1
Date start	(DATSTA)	ISO 8601: 2004	(S) TD	0,1
MMSI code			IN	0,1
Periodic date range			C	0,*
Date end	(PEREND)	ISO 8601: 2004	(S) TD	1,1
Date start	(PERSTA)	ISO 8601: 2004	(S) TD	1,1
Status	(STATUS)	1 : permanent 5 : periodic/intermittent 7 : temporary	EN	0,1
Scale minimum	(SCAMIN)	See clause X.X	IN	0,1

INT 1 Reference: S 17

21.2.1 Physical Automatic Identification System (AIS) aids to navigation (see S-4 – B-480-484)

If it is required to encode a physical AIS aid to navigation, it must be done using the feature **Physical AIS Aid to Navigation**.

Remarks:

- Physical AIS aids to navigation must be encoded, where required, using the geometry of the physical aid to navigation from which the AIS signal is, or appears to be, transmitted. If it is required to encode the actual location from which the signal is transmitted for a physical AIS aid to navigation where the signal is transmitted from another location, it must be done using a **Radio Station** feature (see clause X.X), with attribute **category of radio station** = 16 (AIS base station).
- The unique Maritime Mobile Service Identity (MMSI) code for the physical AIS aid to navigation should be encoded, where known, using the attribute **MMSI code**.

Distinction: Radar station; radio station; radio calling-in point; virtual AIS aid to navigation.

Feature/Information associations

Type	Association Name	Association Ends					
		Class	Role	Mult	Class	Role	Mult
Comp	Structure/Equipment	Physical AIS Aid to Navigation	Supports	1,1	Beacon Cardinal, Beacon Isolated Danger, Beacon Lateral, Beacon Safe Water, Beacon Special Purpose/General, Bridge, Building, Buoy Cardinal, Buoy Emergency Wreck Marking, Buoy Installation, Buoy Isolated Danger, Buoy Lateral, Buoy Safe Water, Buoy Special Purpose/General, Crane, Conveyor, Daymark, Fishing Facility, Floating Dock, Fortified Structure, Hulk, Landmark, Light Float, Light Vessel, Mooring/Warping Facility, Offshore Platform, Pile, Pipeline Overhead, Pontoon, Pylon/Bridge Support, Shoreline Construction, Silo/Tank, Span Fixed, Span Opening, Wind Turbine	Supported by	0,1

21.3 Virtual AIS aid to navigation

IHO Definition: AIS AID TO NAVIGATION. An Automatic Identification System (AIS) message 21 transmitted from a physical Aid to Navigation, or transmitted from an AIS station for an Aid to Navigation which does or does not physically exist. (Adapted from IALA Recommendation A-126).

S-101 Geo Feature: Virtual AIS aid to navigation

Primitives: Point

Real World

Paper Chart Symbol

ECDIS Symbol

S-101 Attribute	S-57 Acronym	Allowable Encoding Value	Type	Multiplicity
Estimated range of transmission	(ESTRNG)		RE	0,1
Feature name			C	0,*
Display name			(S) BO	0,1
Language		ISO 639-3	(S) TE	0,1
Name	(OBJNAM) (NOBJNM)		(S) TE	1,1
Fixed date range			C	0,1
Date end	(DATEND)	ISO 8601: 2004	(S) TD	0,1
Date start	(DATSTA)	ISO 8601: 2004	(S) TD	0,1
MMSI code			IN	0,1
Periodic date range			C	0,*
Date end	(PEREND)	ISO 8601: 2004	(S) TD	1,1
Date start	(PERSTA)	ISO 8601: 2004	(S) TD	1,1
Status	(STATUS)	1 : permanent 5 : periodic/intermittent 7 : temporary	EN	0,1
Virtual AIS aid to navigation type		1 : north cardinal 2 : east cardinal 3 : south cardinal 4 : west cardinal 5 : port lateral 6 : starboard lateral 7 : preferred channel to port 8 : preferred channel to starboard 9 : isolated danger 10 : safe water 11 : special purpose 12 : emergency wreck marking	EN	1,1
Scale minimum	(SCAMIN)	See clause X.X	IN	0,1

INT 1 Reference: S 18

21.3.1 Virtual Automatic Identification System (AIS) aids to navigation (see S-4 – B-480-484)

If it is required to encode a virtual AIS aid to navigation, it must be done using the feature **Virtual AIS Aid to Navigation**.

Remarks:

- Virtual AIS aids to navigation should only be encoded where it is known that the Virtual aid is intended to be permanent, or deployed for a specified fixed period. Where it is known that a Virtual AIS aid to navigation is moved or withdrawn on a regular basis and/or at short notice, such that implementing these changes through the application of ENC Updates is impractical, the Virtual aid should not be encoded.
- The unique Maritime Mobile Service Identity (MMSI) code for the virtual AIS aid to navigation should be encoded, where known, using the attribute **MMSI code**.

Distinction: Physical AIS aid to navigation; radar station; radio station; radio calling-in point.

21.4 Radio station

IHO Definition: RADIO STATION. A place equipped to transmit radio waves. Such a station may be either stationary or mobile, and may also be provided with a radio receiver. (IHO Dictionary – S-32).

S-101 Geo Feature: Radio station (RDOSTA)

Primitives: Point

Real World

Paper Chart Symbol

ECDIS Symbol

S-101 Attribute	S-57 Acronym	Allowable Encoding Value	Type	Multiplicity
Call sign	(CALSGN)		TE	0,1
Category of radio station	(CATROS)	5 : radio direction-finding station 8 : Decca 9 : Loran C 10 : Differential GNSS 11 : Toran 12 : Omega 13 : Syledis 14 : Chaika (Chayka) 19 : radio telephone station 20 : AIS base station	EN	0,1
Communication channel	(COMCHA)		TE	0,*
Estimated range of transmission	(ESTRNG)		RE	0,1
Feature name			C	0,*
Display name			(S) BO	0,1
Language		ISO 639-3	(S) TE	0,1
Name	(OBJNAM) (NOBJNM)		(S) TE	1,1
Fixed date range			C	0,1
Date end	(DATEND)	ISO 8601: 2004	(S) TD	0,1
Date start	(DATSTA)	ISO 8601: 2004	(S) TD	0,1
Frequency pair	(SIGFRQ)		C	0,1
Frequency shore station receives			(S) IN	0,1
Frequency shore station transmits			(S) IN	1,1
Periodic date range			C	0,*
Date end	(PEREND)	ISO 8601: 2004	(S) TD	1,1
Date start	(PERSTA)	ISO 8601: 2004	(S) TD	1,1
Status	(STATUS)	1 : permanent 2 : occasional 4 : not in use 5 : periodic/intermittent 7 : temporary 8 : private	EN	0,*
Scale minimum	(SCAMIN)	See clause X.X	IN	0,1

INT 1 Reference: S 10-16

21.4.1 Radio stations (see S-4 – B-480-484)

Transmissions from radio stations may provide mariners with a line of position. Most radio position fixing systems require Radio Direction Finding (RDF) equipment to determine the bearing of the transmitting device; such equipment is generally no longer fitted on vessels. The exception is “emergency use only” VHF-based direction finding services (which do not use RDF equipment). Consequently, the following radio position-fixing stations are now obsolete and there is no longer any value in encoding them on ENC:

- Circular (non-directional) (RC), directional (RD) and rotating pattern (RW) marine radiobeacons;
- Consol beacons (Consol);
- Aeronautical radiobeacons (Aero RC);
- Radio direction-finding stations (except VHF-based emergency stations) (RG);
- Coast Radio Stations providing ‘QTG’ service (R).

The feature “radio station” is used to encode the point of transmission of the signal.

If it is required to encode a radio station, it must be done using the feature **Radio Station**.

Remarks:

- The **Radio Station** must only be used to encode the technical equipment itself, independent of the building or structure in which it is installed. If it is required to encode the building or structure (for example mast, tower, radar dome), it must be done using an appropriate feature (for example **Building, Landmark**). There is no requirement to establish a Structure/Equipment association between the **Radio Station** feature and the structure in which it is installed.
- Further information (for example transmission characteristic) may be encoded using an associated instance of the information class **Nautical Information** (see clause X.X), complex attribute **information**.
- Each VHF-channel should be indicated, using the attribute **communication channel** (see clause X.X).
- If it is required to encode a DGPS station, it must be done using **Radio Station**, with attribute **category of radio station** = 10 (Differential GNSS).
- Where required, the attribute **signal frequency** must be quoted in Hertz, for example a signal frequency of 950 MHz must be encoded as 950000000.

21.4.2 Radio direction-finding stations (see S-4 – B-483)

If it is required to encode a radio direction-finding station, it must be done using a **Radio Station** feature, with attribute **category of radio station** = 5 (radio direction-finding station). The identification signal may be encoded using the attribute **call sign**.

Remarks:

- Direction-finding is now only provided as an emergency service by VHF.

Distinction: Physical AIS aid to navigation; radar station; radio calling-in point; virtual AIS aid to navigation.

21.5 Radar transponder beacon

IHO Definition: **RADAR TRANSPONDER BEACON.** A transponder beacon transmitting a coded signal on radar frequency, permitting an interrogating craft to determine the bearing and range of the transponder. Also called racon. (IHO Dictionary – S-32).

S-101 Geo Feature: Radar transponder beacon (RTPBCN)

Primitives: Point

<i>Real World</i>	<i>Paper Chart Symbol</i>	<i>ECDIS Symbol</i>
-------------------	---------------------------	---------------------

S-101 Attribute	S-57 Acronym	Allowable Encoding Value	Type	Multiplicity
Category of radar transponder beacon	(CATRTB)	1 : ramark, radar beacon transmitting continuously 2 : racon, radar transponder beacon 3 : leading racon/radar transponder beacon	EN	1,1
Feature name			C	0,*
Display name			(S) BO	0,1
Language		ISO 639-3	(S) TE	0,1
Name	(OBJNAM) (NOBJNM)		(S) TE	1,1
Fixed date range			C	0,1
Date end	(DATEND)	ISO 8601: 2004	(S) TD	0,1
Date start	(DATSTA)	ISO 8601: 2004	(S) TD	0,1
Periodic date range			C	0,*
Date end	(PEREND)	ISO 8601: 2004	(S) TD	1,1
Date start	(PERSTA)	ISO 8601: 2004	(S) TD	1,1
Radar wave length	(RADWAL)		C	0,2
Radar band			(S) TE	1,1
Wave length value			(S) RE	1,1
Sector limit			C	0,1
Sector limit one	(SECTR1)		(S) C	1,1
Sector bearing			(S) RE	1,1
Sector line length			(S) RE	0,1
Sector limit two	(SECTR2)		(S) C	1,1
Sector bearing			(S) RE	1,1
Sector line length			(S) RE	0,1
Signal group	(SIGGRP)		TE	0,1
Signal sequence	(SIGSEQ)		C	0,* (ordered)
Signal duration			(S) RE	1,1
Signal status		1 : lit/sound	(S) EN	1,1

		2 : eclipsed/silent		
Status	(STATUS)	1 : permanent 2 : occasional 4 : not in use 5 : periodic/intermittent 7 : temporary 8 : private	EN	0,*
Value of maximum range	(VALMXR)		RE	0,1
Scale minimum	(SCAMIN)	See clause X.X	IN	0,1

INT 1 Reference: S 2-3

21.5.1 Radar beacons (see S-4 – B-486)

Radar beacons are transmitters operating in the marine radar frequency band. The signals produce a characteristic line on a vessel's radar display enabling the mariner to determine their position with greater certainty than would be possible by means of a normal radar display alone.

If it is required to encode a radar beacon, it must be done using the feature **Radar Transponder Beacon**.

Remarks:

- The **Radar Transponder Beacon** must only be used to encode the technical equipment itself, independent of the building or structure in which it is installed. If it is required to encode the building or structure (for example mast, tower, radar dome), it must be done using an appropriate feature (for example **Building, Landmark**).
- The attribute **signal group** is used to encode Morse identification letter(s) for the radar beacon, where known.
- Leading racons are established such that, when their bearing lines are coincident on a vessel's radar display, the bearing serves to indicate the track to be followed. If it is required to encode the bearing line and the recommended track for leading racons, it must be done as described in clause X.X. Where the bearing line coincides with a leading line defined by lights or other visual features making up a range system, navigation lines and recommended tracks must not be duplicated. The features making up the range system should be associated with a feature **Range System** (see clause X.X) using the association **Range System Aggregation** (see clause X.X). NOTE: All features comprising a range system must have the same value populated for the attribute **scale minimum** (see clause X.X).
- If, for some reason, the radar transponder beacon signal is obscured between certain bearings, this information should be encoded using the complex attribute **sector limit** to encode the "visible" sector, as for lights (see clause X.X).
- The sweep period may be encoded using an associated instance of the information class **Nautical Information** (see clause X.X), complex attribute **information**.

Distinction: Radar line; radar range; radar station.

Feature/Information associations							
Type	Association Name	Association Ends					
		Class	Role	Mult	Class	Role	Mult
Comp	Structure/Equipment	Radar Transponder Beacon	Supports	1,1	Beacon Cardinal, Beacon Isolated Danger, Beacon Lateral, Beacon Safe Water, Beacon Special Purpose/General, Bridge, Building, Buoy Cardinal, Buoy Emergency Wreck Marking, Buoy Installation, Buoy Isolated Danger, Buoy Lateral, Buoy Safe Water, Buoy Special	Supported by	0,1

					Purpose/General, Crane, Conveyor, Daymark, Fishing Facility, Floating Dock, Fortified Structure, Hulk, Landmark, Light Float, Light Vessel, Mooring/Warping Facility, Offshore Platform, Pile, Pipeline Overhead, Pontoon, Pylon/Bridge Support, Shoreline Construction, Silo/Tank, Span Fixed, Span Opening, Wind Turbine		
--	--	--	--	--	--	--	--

22 Geo Features – Services

22.1 Pilot boarding place

IHO Definition: **PILOT BOARDING PLACE.** A location offshore where a pilot may board a vessel in preparation to piloting it through local waters. (Defence Geospatial Information Working Group; Feature Data Dictionary Register, 2010).

S-101 Geo Feature: Pilot boarding place (PILBOP)

Primitives: Point, Surface

Real World

Paper Chart Symbol

ECDIS Symbol

S-101 Attribute	S-57 Acronym	Allowable Encoding Value	Type	Multiplicity
Category of pilot boarding place	(CATPIL)	1 : boarding by pilot-cruising vessel 2 : boarding by helicopter 3 : pilot comes out from shore	EN	0,1
Feature name			C	0,*
Display name			(S) BO	0,1
Language		ISO 639-3	(S) TE	0,1
Name	(OBJNAM) (NOBJNM)		(S) TE	1,1
Fixed date range			C	0,1
Date end	(DATEND)	ISO 8601: 2004	(S) TD	0,1
Date start	(DATSTA)	ISO 8601: 2004	(S) TD	0,1
Periodic date range			C	0,*
Date end	(PEREND)	ISO 8601: 2004	(S) TD	1,1
Date start	(PERSTA)	ISO 8601: 2004	(S) TD	1,1
Status	(STATUS)	1 : permanent 2 : occasional 5 : periodic/intermittent 6 : reserved 9 : mandatory 16 : watched 17 : un-watched 28 : buoyed	EN	0,*
Scale minimum	(SCAMIN)	See clause X.X	IN	0,1

INT 1 Reference: T 1.1-4

22.1.1 Pilot boarding places (see S-4 – B-491.1-2)

For a pilot boarding place, the pilot vessel may either cruise in the area or come out on request. Off some large ports pilots on outgoing ships may be disembarked at a different location. Pilots may board from a helicopter; it is then less important for a ship to reach the exact position of the boarding place but an approximate position should still be encoded. Some pilot stations are used solely for long-distance (deep-sea) pilots. Pilots may be in constant attendance, in regular attendance at certain limited times, or available by previous arrangement only. The primary purpose of encoded pilotage information is to show the position of

the facility. Because of the many variations in the service provided, the main source of information on pilotage must be in an associated publication or product.

If it is required to encode a pilot boarding place, it must be done using the feature **Pilot Boarding Place**.

Remarks:

- If it is required to encode the ship to shore or shore to ship contact information, it must be done using the information class **Contact Details** (see clause X.X). The **Contact Details** must be associated to the **Pilot Boarding Place** feature using the association **additional information**.
- If it is required to encode the area in which pilotage regulations apply, it should be done using the feature **Pilotage District** (see clause X.X). The relationship between the pilotage district and any associated pilot boarding places should be encoded using the feature association **Pilotage District Association** (see clause X.X).

22.1.2 Pilot stations ashore (see S-4 – B-491.4)

If it is required to encode a pilot station ashore, it must be done using a **Building** or **Landmark** feature, with attribute **function** = 11 (pilot office) or 12 (pilot lookout).

Distinction: Pilotage district.

<u>Feature/Information associations</u>							
Type	Association Name	Association Ends					
		Class	Role	Mult	Class	Role	Mult
Comp	Pilotage District Association	Pilot Boarding Place	Consists of	1,*	Pilotage District	Component of	0,1
Asso	Additional Information	Pilot Boarding Place	Provides information	1,*	Contact Details	Information provided for	0,1

22.2 Vessel traffic service area

IHO Definition: **VESSEL TRAFFIC SERVICE.** The area of any service implemented by a relevant authority primarily designed to improve safety and efficiency of traffic flow and the protection of the environment. It may range from simple information messages, to extensive organisation of the traffic involving national or regional schemes. (IHO Dictionary – S-32).

S-101 Geo Feature: Vessel traffic service area

Primitives: Surface

Real World

Paper Chart Symbol

ECDIS Symbol

S-101 Attribute	S-57 Acronym	Allowable Encoding Value	Type	Multiplicity
Feature name			C	0,*
Display name			(S) BO	0,1
Language		ISO 639-3	(S) TE	0,1
Name	(OBJNAM) (NOBJNM)		(S) TE	1,1
Scale minimum	(SCAMIN)	See clause X.X scale minimum > scale maximum	IN	0,1

INT 1 Reference:

22.2.1 Vessel traffic service area

If it is required to encode an area within which a competent authority provides services to vessels as part of a Vessel Traffic Service (VTS), it must be done using the feature **Vessel Traffic Service Area**. The area should be captured based on the limits of the VTS or VTS sector.

Remarks:

- Separate **Vessel Traffic Service Area** features should be captured for individual VTS sectors where appropriate.

Distinction: Administration area; custom zone.

Feature/Information associations

Type	Association Name	Association Ends					
		Class	Role	Mult	Class	Role	Mult
Asso	Additional Information	Vessel Traffic Service Area	Provides information	1,*	Contact Details	Information provided for	0,1

22.3 Coastguard station

IHO Definition: **COASTGUARD STATION.** A station at which a visual/radio/radar marine watch is kept either continuously or at certain times only. (IHO Dictionary – S-32).

S-101 Geo Feature: Coastguard station (CGUSTA)

Primitives: Point, Surface

Real World

Paper Chart Symbol

ECDIS Symbol

S-101 Attribute	S-57 Acronym	Allowable Encoding Value	Type	Multiplicity
Communication channel	(COMCHA)		TE	0,*
Feature name			C	0,*
Display name			(S) BO	0,1
Language		ISO 639-3	(S) TE	0,1
Name	(OBJNAM) (NOBJNM)		(S) TE	1,1
Fixed date range			C	0,1
Date end	(DATEND)	ISO 8601: 2004	(S) TD	0,1
Date start	(DATSTA)	ISO 8601: 2004	(S) TD	0,1
Is MRCC			BO	0,1
Periodic date range			C	0,*
Date end	(PEREND)	ISO 8601: 2004	(S) TD	1,1
Date start	(PERSTA)	ISO 8601: 2004	(S) TD	1,1
Status	(STATUS)	1 : permanent 4 : not in use 5 : periodic/intermittent 16 : watched 17 : un-watched	EN	0,*
Scale minimum	(SCAMIN)	See clause X.X	IN	0,1

INT 1 Reference: T 10, 11

22.3.1 Coastguard stations (see S-4 – B-492)

The organisation of coast-watching and rescue services differs from country to country. For charting purposes it is assumed that two distinct functions can be recognised, even though they may be parts of the same organisation co-ordinating and effecting life saving and performing other services. Coastguard stations are stations at which a watch is kept either continuously, or at certain times only. They are sited so as to have a commanding view, are often associated with signal stations, and are visually prominent. They are also referred to as watch-keeping stations.

Coastguard stations are located along the coasts of most maritime nations. Their primary purpose in former days was to enforce customs regulations, observe the movements of ships and to watch for signs of distress at sea. These functions are largely superseded by modern telecommunications and Search & Rescue (SAR) arrangements, coordinated by regional Maritime Rescue and Coordination Centres (MRCC).

If it is required to encode a coastguard station, it must be done using the feature **Coastguard Station**.

Remarks:

- Many modern Coastguard services no longer maintain visual watch from fixed stations. However, because

stations were usually situated so as to have a commanding view and may therefore be visually prominent and make good fixing marks, the buildings may still be encoded as **Building** or **Landmark**.

- The **Coastguard Station** must only be used to describe the function of the coastguard station, independent of the building or structure itself. If it is required to encode the building or structure in which the coastguard station operates, it must be done using an appropriate feature (for example **Building, Landmark**).
- Maritime Rescue and Coordination Centres (MRCC) are part of a constantly manned communications watch system. If it is required to encode a MRCC, it should be done using **Coastguard Station**, with the Boolean attribute **is MRCC = True**. The name of the station may be populated using the complex attribute **feature name** (sub-attribute **name**), for example *MRCC Swansea*.
- Each VHF-channel should be indicated, using the attribute **communication channel** (see clause **X.X**).

Distinction: Building; rescue station.

22.4 Warning signal stations

IHO Definition: **SIGNAL STATION, WARNING.** A warning signal station is a place on shore from which warning signals are made to ships at sea. (Adapted from IHO Dictionary – S-32 and Defence Geospatial Information Working Group; Feature Data Dictionary Register, 2012).

S-101 Geo Feature: Signal station warning (SISTAW)

Primitives: Point, Surface

Real World

Paper Chart Symbol

ECDIS Symbol

S-101 Attribute	S-57 Acronym	Allowable Encoding Value	Type	Multiplicity
Category of signal station warning	(CATSIW)	1 : danger 2 : maritime obstruction 3 : cable 4 : military practice 5 : distress 6 : weather 7 : storm 8 : ice 9 : time 10 : tide 11 : tidal stream 12 : tide gauge 13 : tide scale 14 : diving 15 : water level gauge	EN	1,*
Communication channel	(COMCHA)		TE	0,*
Feature name			C	0,*
Display name			(S) BO	0,1
Language		ISO 639-3	(S) TE	0,1
Name	(OBNAM) (NOBJNM)		(S) TE	1,1
Fixed date range			C	0,1
Date end	(DATEND)	ISO 8601: 2004	(S) TD	0,1
Date start	(DATSTA)	ISO 8601: 2004	(S) TD	0,1
Periodic date range			C	0,*
Date end	(PEREND)	ISO 8601: 2004	(S) TD	1,1
Date start	(PERSTA)	ISO 8601: 2004	(S) TD	1,1
Status	(STATUS)	1 : permanent 2 : occasional 4 : not in use 5 : periodic/intermittent 7 : temporary 8 : private 12 : illuminated 14 : public 15 : synchronized 16 : watched 17 : un-watched	EN	0,*

Scale minimum	(SCAMIN)	See clause X.X	IN	0,1
<p><u>INT 1 Reference:</u> T 20, 26, 28-36</p> <p>22.4.1 Warning signal stations (see S-4 – B-494; B-496-7)</p> <p>Signal stations communicating visually have declined in importance. They are encoded on the largest maximum display scale ENC data not only for their main role of signalling information and instructions but also as a form of landmark. The signals generally exhibit lights by day and night but may display shapes or flags by day.</p> <p>If it is required to encode a warning signal station, it must be done using the feature Signal Station Warning.</p> <p><u>Remarks:</u></p> <ul style="list-style-type: none"> The Signal Station Warning must only be used to describe the function of the signal station, independent of the building or structure itself. If it is required to encode the building or structure housing the service, it must be done using an appropriate feature (for example Building, Landmark). Each VHF-channel should be indicated, using the attribute communication channel (see clause X.X). <p><u>Distinction:</u> Signal station, traffic.</p>				

Feature/Information associations							
Type	Association Name	Association Ends					
		Class	Role	Mult	Class	Role	Mult
Comp	Structure/Equipment	Signal Station Warning	Supports	1,1	Beacon Cardinal, Beacon Isolated Danger, Beacon Lateral, Beacon Safe Water, Beacon Special Purpose/General, Bridge, Building, Buoy Cardinal, Buoy Emergency Wreck Marking, Buoy Installation, Buoy Isolated Danger, Buoy Lateral, Buoy Safe Water, Buoy Special Purpose/General, Crane, Conveyor, Daymark, Fishing Facility, Floating Dock, Fortified Structure, Hulk, Landmark, Light Float, Light Vessel, Mooring/Warping Facility, Offshore Platform, Pile, Pipeline Overhead, Pontoon, Pylon/Bridge Support, Shoreline Construction, Silo/Tank, Span Fixed, Span Opening, Wind Turbine	Supported by	0,1

22.5 Traffic signal stations

IHO Definition: SIGNAL STATION, TRAFFIC. A traffic signal station is a place on shore from which signals are made to regulate the movement of traffic. (Adapted from IHO Dictionary – S-32 and S-57 Edition 3.1, Appendix A – Chapter 1, Page 1.155, November 2000).

S-101 Geo Feature: Signal station traffic (SISTAT)

Primitives: Point, Surface

Real World

Paper Chart Symbol

ECDIS Symbol

S-101 Attribute	S-57 Acronym	Allowable Encoding Value	Type	Multiplicity
Category of signal station traffic	(CATSIT)	1 : port control 2 : port entry and departure 3 : International Port Traffic 4 : berthing 5 : dock 6 : lock 7 : flood barrage 8 : bridge passage 9 : dredging 10 : traffic control light	EN	1,*
Communication channel	(COMCHA)		TE	0,*
Feature name			C	0,*
Display name			(S) BO	0,1
Language		ISO 639-3	(S) TE	0,1
Name	(OBJNAM) (NOBJNM)		(S) TE	1,1
Fixed date range			C	0,1
Date end	(DATEND)	ISO 8601: 2004	(S) TD	0,1
Date start	(DATSTA)	ISO 8601: 2004	(S) TD	0,1
Periodic date range			C	0,*
Date end	(PEREND)	ISO 8601: 2004	(S) TD	1,1
Date start	(PERSTA)	ISO 8601: 2004	(S) TD	1,1
Status	(STATUS)	1 : permanent 2 : occasional 4 : not in use 5 : periodic/intermittent 7 : temporary 8 : private 12 : illuminated 14 : public 15 : synchronized 16 : watched 17 : un-watched	EN	0,*
Scale minimum	(SCAMIN)	See clause X.X	IN	0,1

INT 1 Reference: T 21-25.2

22.5.1 Traffic signal stations (see S-4 – B-494-5)

Signal stations communicating visually have declined in importance. They are encoded on the largest maximum display scale ENC data not only for their main role of signalling information and instructions but also as a form of landmark. The signals generally exhibit lights by day and night but may display shapes or flags by day.

The nature of traffic signals varies from country to country and even from port to port. For charting purposes traffic signals can be considered to include, for instance:

- Port entry and departure signals;
- Lock, docking and berthing signals;
- Bridge signals;
- International traffic signals.

If it is required to encode a traffic signal station, it must be done using the feature **Signal Station Traffic**.

Remarks:

- If it is required to encode a bridge light marking the centre of a navigable span, it must be done using the feature **Light**.
- The **Signal Station Traffic** must only be used to describe the function of the signal station, independent of the building or structure itself. If it is required to encode the building or structure housing the service, it must be done using an appropriate feature (for example **Building, Landmark**).
- Each VHF-channel should be indicated, using the attribute **communication channel** (see clause X.X).

Distinction: Signal station, warning.

Feature/Information associations							
Type	Association Name	Association Ends					
		Class	Role	Mult	Class	Role	Mult
Comp	Structure/Equipment	Signal Station Traffic	Supports	1,1	Beacon Cardinal, Beacon Isolated Danger, Beacon Lateral, Beacon Safe Water, Beacon Special Purpose/General, Bridge, Building, Buoy Cardinal, Buoy Emergency Wreck Marking, Buoy Installation, Buoy Isolated Danger, Buoy Lateral, Buoy Safe Water, Buoy Special Purpose/General, Crane, Conveyor, Daymark, Fishing Facility, Floating Dock, Fortified Structure, Hulk, Landmark, Light Float, Light Vessel, Mooring/Warping Facility, Offshore Platform, Pile, Pipeline Overhead, Pontoon, Pylon/Bridge Support, Shoreline Construction, Silo/Tank, Span Fixed, Span Opening, Wind Turbine	Supported by	0,1

22.6 Rescue station

IHO Definition: **RESCUE STATION.** A place where equipment for saving life at sea is maintained. Also called life saving station. (IHO Dictionary – S-32).

S-101 Geo Feature: Rescue station (RSCSTA)

Primitives: Point, Surface

Real World

Paper Chart Symbol

ECDIS Symbol

S-101 Attribute	S-57 Acronym	Allowable Encoding Value	Type	Multiplicity
Category of rescue station	(CATRSC)	1 : rescue station with lifeboat 2 : rescue station with rocket 4 : refuge for shipwrecked mariners 5 : refuge for intertidal area walkers 6 : lifeboat lying at a mooring 7 : aid radio station 8 : first aid equipment	EN	0,*
Communication channel	(COMCHA)		TE	0,*
Feature name			C	0,*
Display name			(S) BO	0,1
Language		ISO 639-3	(S) TE	0,1
Name	(OBJNAM) (NOBJNM)		(S) TE	1,1
Fixed date range			C	0,1
Date end	(DATEND)	ISO 8601: 2004	(S) TD	0,1
Date start	(DATSTA)	ISO 8601: 2004	(S) TD	0,1
Periodic date range			C	0,*
Date end	(PEREND)	ISO 8601: 2004	(S) TD	1,1
Date start	(PERSTA)	ISO 8601: 2004	(S) TD	1,1
Status	(STATUS)	1 : permanent 2 : occasional 4 : not in use 5 : periodic/intermittent 7 : temporary 8 : private 14 : public 16 : watched 17 : un-watched	EN	0,*
Scale minimum	(SCAMIN)	See clause X.X	IN	0,1

INT 1 Reference: T 12-14

22.6.1 Rescue station (see S-4 – B-490 and B-493)

The organisation of coast-watching and rescue services differs from country to country. For charting purposes it is assumed that these two distinct functions can be recognised individually, even though they may be parts of the same organisation co-ordinating and effecting life saving and performing other services.

Rescue stations are the places at which life saving equipment is held, especially lifeboats (usually in relatively sheltered positions, near sea level). Rescue stations are not necessarily visually prominent. The range of equipment used in rescue is wide, for example search and rescue helicopters; fast, long-distance lifeboats; inflatable inshore lifeboats.

If it is required to encode a rescue station, it must be done using the feature **Rescue Station**.

Remarks:

- The **Rescue Station** must only be used to describe the function of the rescue station, independent of the building or structure itself. If it is required to encode the building or structure housing the service, it must be done using an appropriate feature (for example **Building, Landmark**).
- If it is required to encode a refuge beacon, it must be done using a **Beacon Special Purpose/General** feature, with attribute **category of special purpose mark = 44** (refuge beacon), not by using **Rescue Station**.
- Each VHF-channel should be indicated, using the attribute **communication channel** (see clause X.X).

Distinction: Beacon special purpose/general; building single; coastguard station.

22.7 Harbour facility

IHO Definition: HARBOUR FACILITY. A Harbour installation with a service or commercial operation of public interest. (S-57 Edition 3.1, Appendix A – Chapter 1, Page 1.81, November 2000).				
S-101 Geo Feature: Harbour facility (HRBFAC)				
Primitives: Point, Surface				
<i>Real World</i>		<i>Paper Chart Symbol</i>		<i>ECDIS Symbol</i>
S-101 Attribute	S-57 Acronym	Allowable Encoding Value	Type	Multiplicity
Category of harbour facility	(CATHAF)	1 : RoRo-terminal 3 : ferry terminal 4 : fishing harbour 5 : yacht harbour/marina 6 : naval base 7 : tanker terminal 8 : passenger terminal 9 : shipyard 10 : container terminal 11 : bulk terminal 12 : ship lift 13 : straddle carrier 14 : service harbour 15 : pilotage service	EN	1,*
Communication channel	(COMCHA)		TE	0,*
Condition	(CONDTN)	1 : under construction 2 : ruined 3 : under reclamation 5 : planned construction	EN	0,1
Feature name			C	0,*
Display name			(S) BO	0,1
Language		ISO 639-3	(S) TE	0,1
Name	(OBJNAM) (NOBJNM)		(S) TE	1,1
Fixed date range			C	0,1
Date end	(DATEND)	ISO 8601: 2004	(S) TD	0,1
Date start	(DATSTA)	ISO 8601: 2004	(S) TD	0,1
Nature of construction	(NATCON)	1 : masonry 2 : concreted 3 : loose boulders 6 : wooden 7 : metal	EN	0,*
Periodic date range			C	0,*
Date end	(PEREND)	ISO 8601: 2004	(S) TD	1,1
Date start	(PERSTA)	ISO 8601: 2004	(S) TD	1,1
Product	(PRODCT)	1 : oil 2 : gas 3 : water 4 : stone	EN	0,1

		5 : coal 6 : ore 7 : chemicals 8 : drinking water 9 : milk 10 : bauxite 11 : coke 12 : iron ingots 13 : salt 14 : sand 15 : timber 16 : sawdust/wood chips 17 : scrap metal 18 : liquefied natural gas (LNG) 19 : liquefied petroleum gas (LPG) 20 : wine 21 : cement 22 : grain 25 : clay		
Reported date	(SORDAT)	ISO 8601: 2004	TD	0,1
Restriction	(RESTRN)	1 : anchoring prohibited 2 : anchoring restricted 3 : fishing prohibited 4 : fishing restricted 5 : trawling prohibited 6 : trawling restricted 8 : entry restricted 9 : dredging prohibited 10 : dredging restricted 11 : diving prohibited 12 : diving restricted 13 : no wake 15 : construction prohibited 16 : discharging prohibited 17 : discharging restricted 18 : industrial or mineral exploration/development prohibited 19 : industrial or mineral exploration/development restricted 20 : drilling prohibited 21 : drilling restricted 23 : cargo transhipment (lightening) prohibited 24 : dragging prohibited 27 : speed restricted	EN	0,*
Status	(STATUS)	1 : permanent 4 : not in use 5 : periodic/intermittent 6 : reserved 7 : temporary 8 : private 9 : mandatory 12 : illuminated 13 : historic 14 : public 16 : watched 17 : un-watched	EN	0,*
Scale minimum	(SCAMIN)	See clause X.X	IN	0,1
INT 1 Reference: F 10, 11.1, 50				

22.7.1 Harbour facilities (see S-4 – B-320 and B-321.5)

If it is required to encode a harbour facility, it must be done using the feature **Harbour Facility**.

Remarks:

- Fishing harbours or ports are equipped to provide for the particular needs of fishing boats. Boat harbours and marinas are areas of sheltered water, generally within harbours or ports, set aside for the use of small craft, usually with moorings, buoys, and, in the case of marinas, berthing facilities.
- Depending on the navigational purpose, harbour facilities are defined by: an area including docks, basins, and dockside equipment; or a point.
- If it is required to encode a terminal with facilities to load/unload or store shipping containers, this should be done using **Harbour Facility** with attribute **category of harbour facility** = 10 (container terminal).
- If it is required to encode a covered terminal into which ships can go, this should be done using **Harbour Facility** with the purpose of the terminal defined by **category of harbour facility**. The roof of the terminal may be encoded using the attribute **nature of construction**, and the maximum height and/or draught of vessels able to use the terminal encoded using an associated instance of the information class **Nautical Information** (see clause X.X), complex attribute **information**. Alternatively, the roofed structure may be encoded using a **Building** feature (see clause X.X).
- Each VHF-channel should be indicated, using the attribute **communication channel** (see clause X.X).

Distinction: Small craft facility.

22.8 Small craft facility

IHO Definition: SMALL CRAFT FACILITY. A place at which a service generally of interest to small craft or pleasure boats is available. (S-57 Edition 3.1, Appendix A – Chapter 1, Page 1.162, November 2000).				
S-101 Geo Feature: Small craft facility (SMCFAC)				
Primitives: Point, Surface				
<i>Real World</i>		<i>Paper Chart Symbol</i>		<i>ECDIS Symbol</i>
S-101 Attribute	S-57 Acronym	Allowable Encoding Value	Type	Multiplicity
Category of small craft facility	(CATSCF)	1 : visitors berth 2 : nautical club 3 : boat hoist 4 : sailmaker 5 : boatyard 6 : public inn 7 : restaurant 8 : chandler 9 : provisions 10 : doctor 11 : pharmacy 12 : water tap 13 : fuel station 14 : electricity 15 : bottle gas 16 : showers 17 : launderette 18 : public toilets 19 : post box 20 : public telephone 21 : refuse bin 22 : car park 23 : parking for boats and trailers 24 : caravan site 25 : camping site 26 : sewerage pump-out station 27 : emergency telephone 28 : landing/launching place for boats 29 : visitors mooring 30 : scrubbing berth 31 : picnic area 32 : mechanics workshop 33 : guard and/or security service	EN	1,*
Feature name			C	0,*
Display name			(S) BO	0,1
Language		ISO 639-3	(S) TE	0,1
Name	(OBJNAM) (NOBJNM)		(S) TE	1,1
Periodic date range			C	0,*
Date end	(PEREND)	ISO 8601: 2004	(S) TD	1,1

Date start	(PERSTA)	ISO 8601: 2004	(S) TD	1,1
Status	(STATUS)	1 : permanent 2 : occasional 3 : recommended 4 : not in use 5 : periodic/intermittent 6 : reserved 7 : temporary 8 : private 9 : mandatory 12 : illuminated 14 : public 16 : watched 17 : un-watched	EN	0,*
Scale minimum	(SCAMIN)	See clause X.X	IN	0,1

INT 1 Reference: E 37.1-2; F 11.3, 19.2; Q 45

22.8.1 Small craft facilities (see S-4 – B-320.1-2)

If it is required to encode a small craft facility, it must be done using the feature **Small Craft Facility**.

Remarks:

- The **Small Craft Facility** must only be used to encode the function. In addition, if it is required to encode a physical feature (for example building, mooring buoy), it must be done using an appropriate feature (for example **Building, Mooring/Warping Facility**).
- Due to possible ECDIS display issues **Small Craft Facility** features of type area should only be encoded on **Land Area, Shoreline Construction** or **Pontoon** features of type area. If it is required to encode a small craft facility in the water, this should be done using the point primitive encoded on the associated physical feature (noting that **Small Craft Facility** of type point do not display in ECDIS).

Distinction: Building; harbour facility; shoreline construction.

23 Cartographic Features

23.1 Text placement

IHO Definition: **TEXT PLACEMENT.** The Text Placement feature is used in association with the Feature Name attribute or a light description to optimise text positioning in ECDIS.

S-101 Cartographic Feature: Text placement

Primitives: Point

<i>Real World</i>	<i>Paper Chart Symbol</i>	<i>ECDIS Symbol</i>		
S-101 Attribute	S-57 Acronym	Allowable Encoding Value	Type	Multiplicity
Flip bearing			RE	0,1
Scale minimum	(SCAMIN)	See clause X.X	IN	0,1
Text justification		1 : left 2 : centred 3 : right	EN	1,1
Text			TE	0,1
Text type		1 : feature name 2 : light characteristic	EN	0,1

INT 1 Reference:

23.1.1 Text placement

If it is required to place text on an ENC to improve clarity of display, it must be done using the cartographic feature **Text Placement**. The **Text Placement** feature must associated with the relevant geo feature using the association **Text Association** (see clause X.X).

Remarks:

- The **Text Placement** feature is used by the ECDIS to position the associated text, which has been populated using an attribute(s) for the related feature. This attribute is identified by populating the attribute **text type**. Alternatively, the text to be displayed may be encoded using the attribute **text**.
- Only one of the attributes **text** or **text type** are allowable for each instance of **Text Placement**.
- **Text Placement** should only be associated with features of type point, and used in areas where it is important that text clear navigationally relevant areas, for example shipping channels and dredged areas.

Distinction:

Feature/Information associations							
Type	Association Name	Association Ends					
		Class	Role	Mult	Class	Role	Mult
Asso	Text Association	Text Placement	Identifies	0,1	All Geo Features	Positions	1,1

24 Information types

24.1 Contact details

IHO Definition: **CONTACT DETAILS.** Information on how to reach a person or organisation by postal, internet, telephone, telex and radio systems.

S-101 Information Type: Contact Details

Primitives: None

<i>Real World</i>		<i>Paper Chart Symbol</i>		<i>ECDIS Symbol</i>	
S-101 Attribute	S-57 Acronym	Allowable Encoding Value	Type	Multiplicity	
Call sign	(CALSGN)		TE	0,1	
Communication channel	(COMCHA)		TE	0,*	
MMSI code			IN	0,1	
Contact instructions	(<i>INFORM</i>)		TE	0,1	
Fixed date range			C	0,1	
Date end	(DATEND)	ISO 8601: 2004	(S) TD	0,1	
Date start	(DATSTA)	ISO 8601: 2004	(S) TD	0,1	
Frequency pair	(<i>SIGFRQ</i>)		C	0,*	
Frequency shore station receives			(S) IN	0,1	
Frequency shore station transmits			(S) IN	0,1	
Online resource			C	0,*	
Headline			(S) TE	0,1	
Linkage		ISO 19115:2014	(S) TE	1,1	
Name of resource		ISO 19115:2014	(S) TE	0,1	
Telecommunications			C	0,*	
Contact instructions			(S) TE	0,1	
Telecommunication identifier			(S) TE	1,1	
Telecommunication service		1 : voice 2 : facsimile 3 : SMS 4 : data 5 : streamed data 6 : telex 7 : telegraph 8 : email other : [something]	(S) CL	0,*	

INT 1 Reference:

24.1.1 Contact details

If it is required to encode the contact information (communication channel, call sign, radio frequency etc.), it must be done using the information class **Contact Details**. Each instance of **Contact Details** must be associated to the feature(s) to which the information applies using the association **Additional Information**

(see clause X.X).

Remarks:

- The frequency at which vessels receive signals must be populated, where required, using complex attribute **frequency pair**, sub-attribute **frequency shore station transmits**. The frequency at which vessels send signals to shore must be populated, where required, using complex attribute **frequency pair**, sub-attribute **frequency shore station receives**.
- Where required, the values populated within the complex attribute **frequency pair** must be quoted in Hertz, for example a signal frequency of 950 MHz must be encoded as *950000000*.

Distinction: Nautical information.

Feature/Information associations

Type	Association Name	Association Ends					
		Class	Role	Mult	Class	Role	Mult
Asso	Additional Information	Contact Details	Information provided for	0,1	Fog Signal, Pilot Boarding Place, Vessel Traffic Service Area	Provides information	1,*

24.2 Service Hours

IHO Definition: SERVICE HOURS. The time when a regular service is available and known exceptions.				
S-101 Information Type: Service Hours				
Primitives: None				
<i>Real World</i>	<i>Paper Chart Symbol</i>	<i>ECDIS Symbol</i>		
S-101 Attribute	S-57 Acronym	Allowable Encoding Value	Type	Multiplicity
Fixed date range			C	0,1
Date end	(DATEND)	ISO 8601: 2004	(S) TD	0,1
Date start	(DATSTA)	ISO 8601: 2004	(S) TD	0,1
Periodic date range			C	0,*
Date end	(PEREND)	ISO 8601: 2004	(S) TD	1,1
Date start	(PERSTA)	ISO 8601: 2004	(S) TD	1,1
Schedule by day of week			C	1,*
Category of schedule		1 : normal operation 2 : closure 3 : unmanned operation	(S) EN	0,1
Time intervals by day of week			(S) C	1,*
Day of week		1 : Monday 2 : Tuesday 3 : Wednesday 4 : Thursday 5 : Friday 6 : Saturday 7 : Sunday	(S) CL	0,7 (ordered)
Day of week is range			(S) BO	0,1
Time of day start			(S) TI	0,* (ordered)
Time of day end			(S) TI	0,* (ordered)
Time reference		1 : local time 2 : Coordinated Universal Time (UTC)	(S) EN	1,1
Information			C	0,*
File locator			(S) TE	0,1
File reference	(TXTDSC) (NXTDSC)		(S) TE	0,1
Headline			(S) TE	0,1
Language		ISO 639-3	(S) TE	0,1
Text	(INFORM) (NIFORM)		(S) TE	0,1
INT 1 Reference:				
24.2.1 Service hours				

If it is required to encode the time schedules for the operation of a service (for instance the opening and closing times for the opening spans of a bridge), it must be done using the information class **Service Hours**. Each instance of **Service Hours** must be associated to the feature(s) to which the information applies using the association **Additional Information** (see clause X.X).

Remarks:

- The complex attribute **time intervals by day of week**, sub-attribute **day of week is range** indicates whether an instance of **time intervals by day of week** encodes a range of days or discrete days. The day(s) or day range(s) are encoded using sub-attribute **day of week**. Where **day of week is range** is populated as *True*, there must be exactly two instances of the attribute **day of week**. If **day of week** is not populated, this indicates that the same schedule applies every day (Monday through Sunday). Multiple ranges or mixing range with discrete days(s) is not allowed (if this is required another instance of **time intervals by day of week** must be encoded).
- For each instance of **time intervals by day of week**, at least one of the sub-attributes **day of week**, **time of day start** or **time of day end** must be populated. Where populated, the number of instances of **time of day start** must be the same as the number of instances of **time of day end**.
- Overlapping intervals bound to the same feature using the association **Additional Information** are not permitted.
- The complex attributes **fixed date range** and **periodic date range**, when populated for **Service Hours**, apply only to **Service Hours** and not to any feature that it may be associated with.

Distinction: Nautical information; non-standard working day.

Feature/Information associations

Type	Association Name	Association Ends					
		Class	Role	Mult	Class	Role	Mult
Asso	Additional Information	Service Hours	Information provided for	0,1	Span Opening	Provides information	1,*

24.3 Non-Standard Working Day

IHO Definition: **NON-STANDARD WORKING DAY.** Days when many services are not available. Often days of festivity or recreation when normal working hours are limited, especially a national or religious festival, etc.

S-101 Information Type: Non-Standard Working Day

Primitives: None

Real World

Paper Chart Symbol

ECDIS Symbol

S-101 Attribute	S-57 Acronym	Allowable Encoding Value	Type	Multiplicity
Date fixed		ISO 8601: 2004	TD	0,*
Date variable			TE	0,*
Fixed date range			C	0,1
Date end	(DATEND)	ISO 8601: 2004	(S) TD	0,1
Date start	(DATSTA)	ISO 8601: 2004	(S) TD	0,1
Periodic date range			C	0,*
Date end	(PEREND)	ISO 8601: 2004	(S) TD	1,1
Date start	(PERSTA)	ISO 8601: 2004	(S) TD	1,1
Information			C	0,*
File locator			(S) TE	0,1
File reference	(TXTDSC) (NXTDSC)		(S) TE	0,1
Headline			(S) TE	0,1
Language		ISO 639-3	(S) TE	0,1
Text	(INFORM) (NINFOM)		(S) TE	0,1

INT 1 Reference:

24.3.1 Non-standard working days

If it is required to encode the date(s) when an event, festival or national holiday occurs each year, it must be done using the information class **Non-Standard Working Day**. Each instance of **Non-Standard Working Day** must be associated to the feature(s) to which the information applies using the association **Additional Information** (see clause X.X).

Remarks:

- At least one of the attributes **date fixed** or **date variable** must be populated.
- The attribute **date fixed** encodes the date when a festival or national holiday recurs on the same day each year in the Gregorian calendar.
- The complex **date variable** encodes a day which is not fixed in the Gregorian calendar, for instance “the fourth Thursday in November”; “Easter Sunday”.
- The complex attributes **fixed date range** and **periodic date range**, when populated for **Non-Standard Working Day**, apply only to **Non-Standard Working Day** and not to any feature that it may be associated with.
- The complex attribute **information** is used to encode any special conditions or regulations that exist in relation to the date/day populated.

Distinction: Nautical information; service hours.

Feature/Information associations							
Type	Association Name	Association Ends					
		Class	Role	Mult	Class	Role	Mult
Asso	Additional Information	Non-Standard Working Day	Information provided for	0,1	Span Opening	Provides information	1,*

24.4 Nautical information

<u>IHO Definition:</u> NAUTICAL INFORMATION. Nautical information about a related area or facility.				
S-101 Information Type: Nautical Information				
Primitives: None				
<i>Real World</i>		<i>Paper Chart Symbol</i>		<i>ECDIS Symbol</i>
S-101 Attribute	S-57 Acronym	Allowable Encoding Value	Type	Multiplicity
Fixed date range			C	0,1
Date end	(DATEND)	ISO 8601: 2004	(S) TD	0,1
Date start	(DATSTA)	ISO 8601: 2004	(S) TD	0,1
Periodic date range			C	0,*
Date end	(PEREND)	ISO 8601: 2004	(S) TD	1,1
Date start	(PERSTA)	ISO 8601: 2004	(S) TD	1,1
Information			C	1,*
File locator			(S) TE	0,1
File reference	(TXTDSC) (NXTDTS)		(S) TE	0,1
Headline			(S) TE	0,1
Language		ISO 639-3	(S) TE	0,1
Text	(INFORM) (NINFOM)		(S) TE	0,1
Pictorial representation	(PICREP)		TE	0,1
<u>INT 1 Reference:</u>				
24.4.1 Nautical information				
If it is required to encode information which applies to one or more geo features which cannot be encoded using attributes on those features, it must be done using the information class Nautical Information . Each instance of Nautical Information must be associated to the feature(s) to which the information applies using the association Additional Information (see clause X.X).				
<u>Remarks:</u>				
<ul style="list-style-type: none"> The complex attributes fixed date range and periodic date range, when populated for Nautical Information, apply only to Nautical Information and not to any feature that it may be associated with. 				
<u>Distinction:</u> Information area; update information.				

Feature/Information associations							
Type	Association Name	Association Ends					
		Class	Role	Mult	Class	Role	Mult
Asso	Additional Information	Nautical Information	Information provided for	0,1	All Geo Features	Provides information	1,*

24.5 Spatial Quality

IHO Definition: **SPATIAL QUALITY**. Definition required.

S-101 Information Type: Spatial Quality

Primitives: None

Real World

Paper Chart Symbol

ECDIS Symbol

S-101 Attribute	S-57 Acronym	Allowable Encoding Value	Type	Multiplicity
Horizontal position uncertainty	(POSACC)		RE	0,1
Quality of horizontal measurement	(QUAPOS)	1 : surveyed 2 : unsurveyed 3 : inadequately surveyed 4 : approximate 5 : position doubtful 6 : unreliable 9 : estimated 10 : precisely known 11 : calculated	EN	0,1
Vertical uncertainty	(VERACC)		C	0,1
Uncertainty fixed			(S) RE	1,1
Uncertainty variable			(S) RE	0.1

INT 1 Reference:

24.5.1 Spatial quality

Spatial attribute types must contain a referenced geometry and may be associated with spatial quality attributes. Each spatial attribute instance must be referenced by a feature instance or another spatial attribute instance.

Spatial quality attributes are carried in the information class **Spatial quality**. Only points, multipoints and curves can be associated with Spatial quality. Currently no use case for associating surfaces with spatial quality attributes is known, therefore this is prohibited. Vertical uncertainty is prohibited for curves as this dimension is not supported by curves.

Each instance of **Spatial Quality** must be associated to the geometry to which the information applies using the association **Spatial Association** (see clause X.X).

Remarks:

- No remarks.

Distinction: Quality of bathymetric data; quality of non-bathymetric data; quality of survey.

Feature/Information associations

Type	Association Name	Association Ends					
		Class	Role	Mult	Class	Role	Mult
Asso	Spatial Association	Spatial Quality	Defined for	0,1	Spatial Types	Defines	1,*

25 Association Names

25.1 Additional information

Additional information: IHO Definition: A feature association for the binding between at least one instance of a geo feature and an instance of an information type.

Remarks:

- A single information type instance may be associated with more than one geo feature instance.

Role Type	Role	Associated With	Multiplicity
Association	Information provided for	All Geo Features	1,*
	Provides information	Contact Details, Non-Standard Working Day, Service Hours, Nautical Information	0,1

25.2 Aids to navigation association

Aids to navigation association: IHO Definition: A feature association for the binding between navigational aids and the traffic systems (such as routeing measures) that they define.

Remarks:

- No remarks.

Role Type	Role	Associated With	Multiplicity
Association	Consists of	Beacon Cardinal, Beacon Isolated Danger, Beacon Lateral, Beacon Safe Water, Beacon Special Purpose/General, Bridge, Building, Buoy Cardinal, Buoy Emergency Wreck Marking, Buoy Installation, Buoy Isolated Danger, Buoy Lateral, Buoy Safe Water, Buoy Special Purpose/General, Crane, Conveyor, Daymark, Fishing Facility, Floating Dock, Fortified Structure, Hulk, Landmark, Light Float, Light Vessel, Mooring/Warping Facility, Offshore Platform, Pile, Pipeline Overhead, Pontoon, Pylon/Bridge Support, Shoreline Construction, Silo/Tank, Span Fixed, Span Opening, Wind Turbine	1,*
	Component of	Archipelagic Sea Lane, Bridge, Deep Water Route, Fairway System, Traffic Separation Scheme, Two-Way Route	0,1

25.3 ASL aggregation

ASL aggregation: IHO Definition: A feature association for the binding between an Archipelagic Sea Lane and its component features.

Remarks:

- No remarks.

Role Type	Role	Associated With	Multiplicity
Aggregation	Consists of	Archipelagic Sea Lane Area, Archipelagic Sea Lane Axis	1,*
	Component of	Archipelagic Sea Lane	0,1

25.4 Bridge aggregation

Bridge aggregation: IHO Definition: A feature association for the binding between a bridge and its component features.

Remarks:

- A bridge over non-navigable water at the maximum display scale of the ENC data, which does not require its individual components to be encoded, must be encoded, where required, as a **Bridge** feature of type curve or surface (see clause X.X).

Role Type	Role	Associated With	Multiplicity
Aggregation	Consists of	Span Fixed, Span Opening, Pylon/Bridge Support	1,*
	Component of	Bridge	0,1

25.5 Caution area association

Caution area association: IHO Definition: A feature association for the binding between a caution area and the traffic systems (such as routing measures) to which the cautionary information applies.

Remarks:

- No remarks.

Role Type	Role	Associated With	Multiplicity
Association	Consists of	Caution Area	1,*
	Component of	Archipelagic Sea Lane	0,1

25.6 Deep Water route aggregation

Deep Water route aggregation: IHO Definition: A feature association for the binding between a Deep Water route and its component features.

Remarks:

- No remarks.

Role Type	Role	Associated With	Multiplicity
Aggregation	Consists of	Deep Water Route Centreline, Deep Water Route Part	2,*
	Component of	Deep Water Route	0,1

25.7 Fairway aggregation

Fairway aggregation: IHO Definition: A feature association for the binding between related fairways comprising a fairway system.

Remarks:

- No remarks.

Role Type	Role	Associated With	Multiplicity
Aggregation	Consists of	Fairway	2,*
	Component of	Fairway System	0,1

25.8 Fairway auxiliary

Fairway aggregation: IHO Definition: A feature association for the binding between a fairway and related features auxiliary to the fairway.

Remarks:

- No remarks.

Role Type	Role	Associated With	Multiplicity
Aggregation	Has auxiliary	Beacon Cardinal, Beacon Isolated Danger, Beacon Lateral, Beacon Safe Water, Beacon Special Purpose/General, Buoy Cardinal, Buoy Emergency Wreck Marking, Buoy Isolated Danger, Buoy Lateral, Buoy Safe Water, Buoy Special Purpose/General, Caution Area, Daymark, Dredged Area, Light Float, Light Vessel, Landmark, Pile, Range System, Recommended Route Centreline, Recommended Track, Restricted Area Navigational, Restricted Area Regulatory, Swept Area	1,*
	Auxiliary to	Fairway	0,1

25.9 Island aggregation

Island aggregation: IHO Definition: A feature association for the binding between a named group of islands.

Remarks:

- No remarks.

Role Type	Role	Associated With	Multiplicity
Aggregation	Consists of	Land Area, Island Group	2,*
	Component of	Island Group	0,1

25.10 Pilotage district association

Pilotage district association: IHO Definition: A feature association for the binding between a pilotage district and its component pilot boarding places.

Remarks:

- No remarks.

Role Type	Role	Associated With	Multiplicity
Aggregation	Consists of	Pilot Boarding Place	1,*
	Component of	Pilotage District	0,1

25.11 Range system aggregation

Range system aggregation: IHO Definition: A feature association for the binding between navigational tracks and the navigational aids that define the tracks.

Remarks:

- All features comprising a range system must have the same value populated for the attribute **scale minimum** (see clause X.X).

Role Type	Role	Associated With	Multiplicity
Aggregation	Consists of	Beacon Cardinal, Beacon Isolated Danger, Beacon Lateral, Beacon Safe Water, Beacon Special	2,*

		Purpose/General, Building, Daymark, Fortified Structure, Landmark, Light All Around, Light Sector, Mooring/Warping Facility, Navigation Line, Pile, Range System, Recommended Route Centreline, Recommended Track, Silo/Tank,	
	Component of	Range System	0,1

25.12 Spatial association

Spatial association: IHO Definition: An association for the binding between a spatial type and its spatial quality information.

Remarks:

- No remarks.

Role Type	Role	Associated With	Multiplicity
Association	Defined for	Spatial types	1,*
	Defines	Spatial Quality	0,1

25.13 Structure/equipment

Structure/equipment: IHO Definition: A feature association for the binding between a navigation aid equipment feature and the structure that supports it.

Remarks:

- Valid structure and equipment features are listed in clause X.X.

Role Type	Role	Associated With	Multiplicity
Composition	Supports	Daymark, Fog Signal, Light All Around, Light Fog Detector, Light Sector, Physical AIS Aid to Navigation, Radar Reflector, Radar Transponder Beacon, Retroreflector, Signal Station Traffic, Signal Station Warning	1,*
	Supported by	Beacon Cardinal, Beacon Isolated Danger, Beacon Lateral, Beacon Safe Water, Beacon Special Purpose/General, Bridge, Building, Buoy Cardinal, Buoy Emergency Wreck Marking; Buoy Installation, Buoy Isolated Danger, Buoy Lateral, Buoy Safe Water, Buoy Special Purpose/General, Crane, Conveyor, Daymark, Fishing Facility, Floating Dock, Fortified Structure, Hulk, Landmark, Light Float, Light Vessel, Landmark, Mooring/Warping Facility, offshore Platform, Pile, Pipeline Overhead, Pontoon, Pylon/Bridge Support, Shoreline Construction, Silo/Tank, Span Fixed, Span Opening, Wind Turbine	0,1

25.14 Text association

Text association: IHO Definition: A feature association for the binding between a geo feature and the cartographically positioned location for text.

Remarks:

- No remarks.

Role Type	Role	Associated With	Multiplicity
Association	Identifies	All Geo Features	1,1
	Positions	Text Placement	0,1

25.15 Traffic Separation Scheme aggregation

<p>Traffic Separation Scheme aggregation: <u>IHO Definition:</u> A feature association for the binding between a Traffic Separation Scheme or a Traffic Separation Scheme System and its component features.</p> <p><u>Remarks:</u></p> <ul style="list-style-type: none"> No remarks. 			
Role Type	Role	Associated With	Multiplicity
Aggregation	Consists of	Beacon Cardinal, Beacon Isolated Danger, Beacon Lateral, Beacon Safe Water, Beacon Special Purpose/General, Buoy Cardinal, Buoy Emergency Wreck Marking; Buoy Isolated Danger, Buoy Lateral, Buoy Safe Water, Buoy Special Purpose/General, Caution Area, Daymark, Deep Water Route, Deep Water Route Centreline, Deep Water Route Part, Inshore Traffic Zone, Landmark, Light Float, Light Vessel, Pile, Precautionary Area, Restricted Area Navigational, Restricted Area Regulatory, Traffic Separation Line, Traffic Separation Scheme, Traffic Separation Scheme Boundary, Traffic Separation Scheme Crossing, Traffic Separation Scheme Lane Part, Traffic Separation Scheme Roundabout, Traffic Separation Zone, Two-Way Route, Two-Way Route Part	2,*
	Component of	Traffic Separation Scheme	0,1

25.16 Two-way route aggregation

<p>Two-way route aggregation: <u>IHO Definition:</u> A feature association for the binding between a two-way route and its component features.</p> <p><u>Remarks:</u></p> <ul style="list-style-type: none"> No remarks. 			
Role Type	Role	Associated With	Multiplicity
Aggregation	Consists of	Two-Way Route Part	2,*
	Component of	Two-Way Route	0,1

25.17 Updated information

<p>Updated information: <u>IHO Definition:</u> A feature association for the binding between an update information metadata feature and updated feature(s) that it identifies.</p> <p><u>Remarks:</u></p> <ul style="list-style-type: none"> An updated dataset feature can be any feature type instance that is subject to an ENC Update. 			
Role Type	Role	Associated With	Multiplicity
Association	Identifies	All Geo Features	1,1
	Updates	Update Information	0,1

26 Association Roles

26.1 Auxiliary to

Component of: IHO Definition: A pointer to incidental, secondary or supplementary features related to the referenced feature.

26.2 Component of

Component of: IHO Definition: A pointer to a part in a whole-part relationship.

26.3 Consists of

Consists of: IHO Definition: A pointer to the aggregate in a whole-part relationship.

26.4 Defined for

Defined by: IHO Definition: A pointer to a specific spatial type(s).

26.5 Defines

Defines: IHO Definition: A pointer to an information type providing spatial quality information.

26.6 Has auxiliary

Component of: IHO Definition: A pointer to a feature to which incidental, secondary or supplementary features are related.

26.7 Identifies

Identifies: IHO Definition: A pointer to a specific feature(s).

26.8 Information provided for

Provided by: IHO Definition: A pointer to a specific feature(s) for which further information is required.

26.9 Positions

Positions: IHO Definition: A pointer to a specific cartographically positioned location for text.

26.10 Provides information

Provides: IHO Definition: A pointer to an object that provides more information about the referencing feature or information type.

26.11 Supported by

Supported by: IHO Definition: A pointer to the master feature that equipment feature(s) are supported by.

26.12 Supports

Supports: IHO Definition: A pointer to the equipment feature(s) supported by a master feature.

26.13 Updates

Updates: IHO Definition: A pointer to a feature that has been updated.

27 Geo Feature Attribute and Enumerate Descriptions

27.1 Beacon shape (BCNSHP)

Beacon Shape: IHO Definition: Describes the characteristic geometric form of the beacon. (Defence Geospatial Information Working Group; Feature Data Dictionary Register, 2010).

1) **Stake, pole, perch, post**

IHO Definition: An elongated wood or metal pole, driven into the ground or seabed, which serves as a navigational aid or a support for a navigational aid. (Adapted from IHO Dictionary – S-32).

2) **Withy**

IHO Definition: A tree without roots stuck or spoiled into the bottom of the sea to serve as a navigational aid. (S-57 Edition 3.1, Appendix A – Chapter 2, Page 2.5, November 2000).

3) **Beacon tower**

IHO Definition: A structure of the order of 10 metres in height used as a navigational aid. (S-57 Edition 3.1, Appendix A – Chapter 2, Page 2.5, November 2000).

5) **Pile beacon**

IHO Definition: A long heavy timber(s) or section(s) of steel, wood, concrete, etc., forced into the seabed to serve as an aid to navigation or as a support for an aid to navigation. (Adapted from IHO Dictionary – S-32 and Navigation Dictionary, US National Oceanic and Atmospheric Administration - NOAA, 1969).

6) **Cairn**

IHO Definition: A mound of stones, usually conical or pyramidal, raised specifically for maritime navigation. (Adapted from IHO Dictionary – S-32).

7) **Buoyant beacon**

IHO Definition: A tall spar-like beacon fitted with a permanently submerged buoyancy chamber, the lower end of the body is secured to seabed sinker either by a flexible joint or by a cable under tension. (S-57 Edition 3.1, Appendix A – Chapter 2, Page 2.5, November 2000).

Remarks:

- No remarks.

27.2 Building shape (BUISHP)

Building shape: IHO Definition: **Definition required.**

5) **High-rise building**

IHO Definition: A building having many storeys. (The New Shorter Oxford English Dictionary, 1993).

6) **Pyramid**

IHO Definition: A polyhedron of which one face is a polygon of any number of sides, and the other faces are triangles with a common vertex. (The New Shorter Oxford English Dictionary, 1993).

7) **Cylindrical**

IHO Definition: Shaped like a cylinder, which is a solid geometrical figure generated by straight lines fixed in direction and describing with one of its points a closed curve, especially a circle. (The New Shorter Oxford English Dictionary, 1993).

8) **Spherical**

IHO Definition: Shaped like a sphere, which is a body the surface of which is at all points equidistant from the centre. (The New Shorter Oxford English Dictionary, 1993).

9) Cubic

IHO Definition: A shape the sides of which are six equal squares; a regular hexahedron. (The New Shorter Oxford English Dictionary, 1993).

Remarks:

- No remarks.

27.3 Buoy shape (BOYSHP)

Buoy shape: IHO Definition: The principal shape and/or design of a buoy. (Defence Geospatial Information Working Group; Feature Data Dictionary Register, 2010).

1) Conical (nun, ogival)

IHO Definition: The upper part of the body above the water-line, or the greater part of the superstructure, has approximately the shape or the appearance of a pointed cone with the point upwards. (S-57 Edition 3.1, Appendix A – Chapter 2, Page 2.7, November 2000).

2) Can (cylindrical)

IHO Definition: The upper part of the body above the water-line, or the greater part of the superstructure, has the shape of a cylinder, or a truncated cone that approximates to a cylinder, with a flat end uppermost. (S-57 Edition 3.1, Appendix A – Chapter 2, Page 2.7, November 2000).

3) Spherical

IHO Definition: The upper part of the body above the water-line, or the greater part of the superstructure, has the shape of a part of a sphere. (S-57 Edition 3.1, Appendix A – Chapter 2, Page 2.7, November 2000).

4) Pillar

IHO Definition: The upper part of the body above the water-line, or the greater part of the superstructure is a narrow vertical structure, pillar or lattice tower. (S-57 Edition 3.1, Appendix A – Chapter 2, Page 2.7, November 2000).

5) Spar (spindle)

IHO Definition: The upper part of the body above the water-line, or the greater part of the superstructure, has the form of a pole, or of a very long cylinder, floating upright. (S-57 Edition 3.1, Appendix A – Chapter 2, Page 2.7, November 2000).

6) Barrel (tun)

IHO Definition: The upper part of the body above the water-line, or the greater part of the superstructure, has the form of a barrel or cylinder floating horizontally. (S-57 Edition 3.1, Appendix A – Chapter 2, Page 2.7, November 2000).

7) Superbuoy

IHO Definition: A very large buoy designed to carry a signal light of high luminous intensity at a high elevation. (IHO Dictionary – S-32).

8) Ice buoy

IHO Definition: A specially constructed shuttle shaped buoy which is used in ice conditions. (S-57 Edition 3.1, Appendix A – Chapter 2, Page 2.7, November 2000).

Remarks:

- The principal shapes are those recommended in the International Association of Lighthouse Authorities - IALA System.

27.4 Buried depth (BURDEP)

Buried depth: IHO Definition: The depth below the seabed to which a feature is buried. (S-57 Edition 3.1,

Appendix A – Chapter 2, Page 2.8, November 2000).

Unit: Defined as an attribute in the ENC dataset metadata: metre (m)

Resolution: 0.1m

Format: xx.x

Example: 2.5 for a depth of 2.5 metres

Remarks:

- No remarks.

27.5 Call sign (CALSGN)

Call sign: IHO Definition: The designated call-sign of a radio station, pilot, (S-57 Edition 3.1, Appendix A – Chapter 2, Page 2.9, November 2000 (as amended)).

Remarks:

- No remarks.

27.6 Category of airport/airfield (CATAIR)

Category of airport/airfield: IHO Definition: Definition required.

1) Military aeroplane airport

IHO Definition: A large military airfield usually equipped with a control tower, hangars and accommodation for the receiving and discharging of passengers or cargo. (Adapted from The Macquarie Dictionary, 1988).

2) Civil aeroplane airport

IHO Definition: A large airfield usually equipped with a control tower, hangars and accommodation for the receiving and discharging of passengers or cargo. (The Macquarie Dictionary, 1988).

3) Military heliport

IHO Definition: A landing place for helicopters controlled by the military. (S-57 Edition 3.1, Appendix A – Chapter 2, Page 2.10, November 2000).

4) Civil heliport

IHO Definition: A landing place for helicopters, often the roof of a building. (The Macquarie Dictionary, 1988).

5) Glider airfield

IHO Definition: An area of land set aside for the take-off and landing of gliders. (S-57 Edition 3.1, Appendix A – Chapter 2, Page 2.10, November 2000).

6) Small planes airfield

IHO Definition: An area of land set aside for the take-off and landing of small aeroplanes. (S-57 Edition 3.1, Appendix A – Chapter 2, Page 2.10, November 2000).

8) Emergency airfield

IHO Definition: An area of land set aside for the take-off and landing of aeroplanes or helicopters in times of emergency. (S-57 Edition 3.1, Appendix A – Chapter 2, Page 2.10, November 2000).

9) Search and rescue airfield

IHO Definition: Definition required.

Remarks:

- No remarks.

27.7 Category of anchorage (CATACH)

Category of anchorage: IHO Definition: **Definition required.**

1) **Unrestricted anchorage**

IHO Definition: An area in which vessels anchor or may anchor. (IHO Dictionary – S-32).

2) **Deep water anchorage**

IHO Definition: An area in which vessels of deep draught anchor or may anchor. (S-57 Edition 3.1, Appendix A – Chapter 2, Page 2.11, November 2000).

3) **Tanker anchorage**

IHO Definition: An area in which tankers anchor or may anchor. (S-57 Edition 3.1, Appendix A – Chapter 2, Page 2.11, November 2000).

4) **Explosives anchorage**

IHO Definition: An area set apart for anchored ships discharging or receiving explosives. (IHO Dictionary – S-32).

5) **Quarantine anchorage**

IHO Definition: An area where a vessel anchors when satisfying quarantine regulations. (IHO Dictionary – S-32).

6) **Seaplane anchorage**

IHO Definition: An area in which seaplanes anchor or may anchor. (S-57 Edition 3.1, Appendix A – Chapter 2, Page 2.11, November 2000).

7) **Small craft anchorage**

IHO Definition: An area in which yachts and small boats anchor or may anchor. (S-57 Edition 3.1, Appendix A – Chapter 2, Page 2.11, November 2000).

8) **Small craft mooring area**

IHO Definition: An area in which yachts and small boats moor. (S-57 Edition 3.1, Appendix A – Chapter 2, Page 2.11, November 2000).

9) **Anchorage for periods up to 24 hours**

IHO Definition: An area in which vessels anchor or may anchor for periods of up to 24 hours. (S-57 Edition 3.1, Appendix A – Chapter 2, Page 2.11, November 2000).

10) **Anchorage for a limited period of time**

IHO Definition: An area in which vessels may anchor for a period of time not to exceed a specific limit. (S-57 Edition 3.1, Appendix A – Chapter 2, Page 2.11, November 2000).

14) **Waiting anchorage**

IHO Definition: **Definition required.**

15) **Reported anchorage**

IHO Definition: **Definition required.**

Remarks:

- No remarks.

27.8 Category of bridge (CATBRG)

Category of bridge: IHO Definition: **Definition required.**

1) **Fixed bridge**

IHO Definition: A bridge having permanent horizontal and vertical alignment. (McGraw-Hill Dictionary of Scientific and Technical Terms, 3rd Edition, 1984).

2) **Opening bridge**

IHO Definition: A bridge that is closed when set for carrying road traffic and open when set to permit marine traffic to pass through the waterway it crosses. Modern opening (movable) bridges are either bascule, vertical lift or swing. (Adapted from McGraw-Hill Encyclopedia of Science and Technology, 7th Edition, 1992).

3) **Swing bridge**

IHO Definition: A movable bridge (or span thereof) which rotates in a horizontal plane about a vertical pivot to allow the passage of vessels. (Adapted from McGraw-Hill Encyclopedia of Science and Technology, 7th Edition, 1992).

4) **Lifting bridge**

IHO Definition: A movable bridge (or span thereof) which is capable of being lifted vertically to allow vessels to pass beneath. (Adapted from IHO Dictionary – S-32).

5) **Bascule bridge**

IHO Definition: A counterpoise bridge rotated in a vertical plane about an axis at one or both ends. Also called a balance bridge. (IHO Dictionary – S-32).

6) **Pontoon bridge**

IHO Definition: A fixed floating bridge supported by pontoons. (McGraw-Hill Dictionary of Scientific and Technical Terms, 3rd Edition, 1984).

7) **Drawbridge**

IHO Definition: A general name for bridges of which part or the entire span of the bridge may be raised or drawn aside to allow ships to pass through. (IHO Dictionary – S-32).

8) **Transporter bridge**

IHO Definition: Consists of towers on each side of the watercourse connected by a system of girders on which a carriage runs. (Defence Geospatial Information Working Group; Feature Data Dictionary Register, 2010).

9) **Footbridge**

IHO Definition: A bridge structure used only for pedestrian traffic. (McGraw-Hill Dictionary of Scientific and Technical Terms, 3rd Edition, 1984).

10) **Viaduct**

IHO Definition: A long bridge consisting of a series of beams, spans or girders (of steel, timber or concrete) supported on towers or piers and used to carry a road, railroad, etc. (Adapted from McGraw-Hill Encyclopedia of Science and Technology, 7th Edition, 1992).

11) **Aqueduct**

IHO Definition: A bridge supporting an artificially elevated channel, for the conveyance of water. (Adapted from The New Shorter Oxford English Dictionary, 1993).

12) **Suspension bridge**

IHO Definition: A fixed bridge consisting of either a roadway or a truss suspended from two or more cables which pass over towers and are anchored by backstays to a firm foundation. (McGraw-Hill Encyclopaedia of Science and Technology, 7th Edition, 1992).

Remarks:

- No remarks.

27.9 Category of built-up area (CATBUA)

Category of built-up area: IHO Definition: **Definition required.**

1) Urban area

IHO Definition: An area predominantly occupied by man-made structures used for residential, commercial, and industrial purposes. (Nautical Chart Manual, US Department of Commerce, 1992).

2) Settlement

IHO Definition: A continuously occupied concentration of tents or lightweight fixed structures (for example: huts) serving as residences. (Defence Geospatial Information Working Group; Feature Data Dictionary Register, 2010).

3) Village

IHO Definition: A self-contained group of houses and associated buildings, usually in a country area. (Defence Geospatial Information Working Group; Feature Data Dictionary Register, 2010).

4) Town

IHO Definition: An inhabited place larger and more regularly built and with more complete and independent local government than a village but not incorporated as a city. (Adapted from Defence Geospatial Information Working Group; Feature Data Dictionary Register, 2010).

5) City

IHO Definition: A major town inhabited by a large permanent community with all essential services. (Defence Geospatial Information Working Group; Feature Data Dictionary Register, 2010).

6) Holiday village

IHO Definition: A complex for holiday-makers with cottages, shops, and entertainment, on site, which is mainly populated on a seasonal basis. (Adapted from Defence Geospatial Information Working Group; Feature Data Dictionary Register, 2010).

Remarks:

- No remarks.

27.10 Category of cable (CATCBL)

Category of cable: IHO Definition: **Definition required.**

1) Power line

IHO Definition: A cable that transmits or distributes electrical power. (Defence Geospatial Information Working Group; Feature Data Dictionary Register, 2010).

3) Transmission line

IHO Definition: Multiple un-insulated cables usually supported by steel lattice towers. Such features are generally more prominent than normal power lines. (S-57 Edition 3.1, Appendix A – Chapter 2, Page 2.16, November 2000).

4) Telephone

IHO Definition: A cable that transmits telephone signals. (Defence Geospatial Information Working Group; Feature Data Dictionary Register, 2010).

5) Telegraph

IHO Definition: A cable that transmits telegraph signals. (Defence Geospatial Information Working Group; Feature Data Dictionary Register, 2010).

6) Mooring cable/chain

IHO Definition: A cable or chain used to secure a mooring buoy or other floating structure. (S-57 Edition

3.1, Appendix A – Chapter 2, Page 2.16, November 2000).

7) Ferry

IHO Definition: A vessel for transporting passengers, vehicles, and/or goods across a stretch of water, especially as a regular service. (Defence Geospatial Information Working Group; Feature Data Dictionary Register, 2016).

A ferry cable is a cable or chain used to facilitate the movement of a ferry. [Needs to be authenticated].

8) Fibre optic cable

IHO Definition: A cable made of glass or plastic fiber designed to guide light along its length, Fibre optic cables are widely used in fiber-optic communication, which permits transmission over longer distances and at higher data rates than other forms of communication.

Remarks:

- No remarks.

27.11 Category of canal (CATCAN)

Category of canal: IHO Definition: Definition required.

1) Transportation

IHO Definition: A canal used for navigation as part of a transport system. (S-57 Edition 3.1, Appendix A – Chapter 2, Page 2.17, November 2000).

2) Drainage

IHO Definition: A canal used to drain excess water from surrounding land. (S-57 Edition 3.1, Appendix A – Chapter 2, Page 2.17, November 2000).

3) Irrigation

IHO Definition: A canal used to supply water for the purpose of irrigation. (S-57 Edition 3.1, Appendix A – Chapter 2, Page 2.17, November 2000).

Remarks:

- No remarks.

27.12 Category of cardinal mark (CATCAM)

Category of cardinal mark: IHO Definition: The four quadrants (north, east, south and west) are bounded by the true bearings NW-NE, NE-SE, SE-SW and SW-NW taken from the point of interest.

A cardinal mark is named after the quadrant in which it is placed.

The name of the cardinal mark indicates that it should be passed to the named side of the mark. (S-57 Edition 3.1, Appendix A – Chapter 2, Page 2.18, November 2000).

1) North cardinal mark

2) East cardinal mark

3) South cardinal mark

4) West cardinal mark

Remarks:

- Cardinal marks do not have a distinctive shape but are normally pillar or spar. To conform to the IALA Maritime Buoyage System, they are always coloured in yellow and black horizontal bands and their distinctive double cone top-marks are always black. Cardinal marks may also have a special system of flashing white lights and if such lights are fitted they are encoded as separate **Light** features.

27.13 Category of checkpoint (CATCHP)

Category of checkpoint: IHO Definition: Definition required.

1) **Custom**

IHO Definition: Serves as a government checkpoint where customs duties are collected, the flow of goods are regulated and restrictions enforced, and shipments or vehicles are cleared for entering or leaving a country. (Defence Geospatial Information Working Group; Feature Data Dictionary Register, 2010).

Remarks:

- No remarks.

27.14 Category of coastline (CATCOA)

Category of coastline: IHO Definition: Definition required.

1) **Steep coast**

IHO Definition: A coast backed by rock or earth cliffs, which gives a good radar return and is useful for visual identification from a considerable distance off, where cliffs alternate with low lying coast along the shoreline. (S-57 Edition 3.1, Appendix A – Chapter 2, Page 2.20, November 2000).

2) **Flat coast**

IHO Definition: A level coast with no obvious topographic features. (S-57 Edition 3.1, Appendix A – Chapter 2, Page 2.20, November 2000).

6) **Glacier, seaward end**

IHO Definition: Projecting seaward extension of glacier, usually afloat. Also called glacier tongue. (IHO Dictionary – S-32).

7) **Mangrove**

IHO Definition: One of several genera of tropical trees or shrubs which produce many prop roots and grow along low lying coasts into shallow water. (IHO Dictionary – S-32).

8) **Marshy shore**

IHO Definition: A shoreline area made up of spongy land saturated with water. It may have a shallow covering of water, usually with a considerable amount of vegetation appearing above the surface. (Adapted from IHO Dictionary – S-32).

10) **Ice coast**

IHO Definition: A vertical cliff forming the seaward edge of an ice shelf, ranging in height between 2 metres to 50 metres or more above sea level. (S-57 Edition 3.1, Appendix A – Chapter 2, Page 2.21, November 2000).

Remarks:

- No remarks.

27.15 Category of conveyor (CATCON)

Category of conveyor: IHO Definition: Definition required.

1) **Aerial cableway (telepheric)**

IHO Definition: A transportation system consisting of load cables strung between pylons on which carrier units (for example: cars or buckets intended to transport people, material, and/or equipment) are suspended. (Defence Geospatial Information Working Group; Feature Data Dictionary Register, 2010).

2) **Belt conveyor**

IHO Definition: A conveyor along which material or people are transported by means of a moving belt. (S-57 Edition 3.1, Appendix A – Chapter 2, Page 2.23, November 2000).

3) **Flume**

IHO Definition: An artificial channel, usually an inclined chute or trough, for carrying water to furnish power, transport logs down a mountainside, etc. (Websters New World Dictionary Third College Edition).

4) **Lift/elevator**

IHO Definition: Definition required.

Remarks:

- No remarks.

27.16 Category of crane (CATCRN)

Category of crane: IHO Definition: Definition required.

2) **Container crane/gantry**

IHO Definition: A high speed, shore-based crane used in the lift-on/lift-off operation of specially constructed containers. (Adapted from Nautical Chart Manual, US Department of Commerce, Coast and Geodetic Survey, 7th Edition).

3) **Sheerlegs**

IHO Definition: A tripodal structure used in dockyards and harbours for stepping masts or lifting loads in to and out of vessels. (S-57 Edition 3.1, Appendix A – Chapter 2, Page 2.25, November 2000).

4) **Travelling crane**

IHO Definition: A crane mounted on rails (track) that can move (usually parallel to the wharf face) in order to load and unload cargo vessels. (Canadian Hydrographic Service).

5) **A-frame**

IHO Definition: A type of crane shaped like the letter “A”. They are often positioned on river banks or the coastline and are used for lifting logs from logging trucks and depositing them in the water. (Canadian Hydrographic Service).

6) **Goliath crane**

IHO Definition: A powerful travelling crane mounted on a movable gantry of large span. (Merriam-Webster Dictionary).

Remarks:

- No remarks.

27.17 Category of dam (CATDAM)

Category of dam: IHO Definition: Definition required.

1) **Weir**

IHO Definition: A dam erected across a river to raise the level of the water. A fence of stakes set in a river or along the shore as a trap for fish. The word is now restricted to smaller works, the larger are called dams. (IHO Dictionary – S-32).

2) **Dam**

IHO Definition: A barrier to check or confine anything in motion; particularly one constructed to hold back water and raise its level to form a reservoir, or to prevent flooding. (IHO Dictionary – S-32).

3) **Flood barrage**

IHO Definition: An opening dam across a channel which, when required, is closed to control flood waters.

(S-57 Edition 3.1, Appendix A – Chapter 2, Page 2.26, November 2000).

Remarks:

- No remarks.

27.18 Category of distance mark (CATDIS)

Category of distance mark: IHO Definition: **Definition required.**

1) **Distance mark not physically installed**

IHO Definition: A point at which a distance from an origin along a feature is given for information, but at which no specific marker exists. (S-57 Edition 3.1, Appendix A – Chapter 2, Page 2.27, November 2000).

2) **Visible mark, pole**

IHO Definition: A point at which a distance from an origin along a feature is given for information and which is marked by a pole. (S-57 Edition 3.1, Appendix A – Chapter 2, Page 2.27, November 2000).

3) **Visible mark, board**

IHO Definition: A point at which a distance from an origin along a feature is given for information and which is marked by a board. (S-57 Edition 3.1, Appendix A – Chapter 2, Page 2.27, November 2000).

4) **Visible mark, unknown shape**

IHO Definition: A point at which a distance from an origin along a feature is given for information and which is physically marked, but the shape of the mark is not known or not given. (S-57 Edition 3.1, Appendix A – Chapter 2, Page 2.27, November 2000).

Remarks:

- No remarks.

27.19 Category of dock (CATDOC)

Category of dock: IHO Definition: **Definition required.**

1) **Tidal**

IHO Definition: A dock which is open to the sea and in which the water level is affected by tides. (S-57 Edition 3.1, Appendix A – Chapter 2, Page 2.28, November 2000).

2) **Non-tidal (wet dock)**

IHO Definition: A dock in which water can be maintained at any level by closing a gate when the water is at the desired level. (IHO Dictionary – S-32).

Remarks:

- No remarks.

27.20 Category of dumping ground (CATDPG)

Category of dumping ground: IHO Definition: **Definition required.**

2) **Chemical waste dumping ground**

IHO Definition: An area at sea where chemical waste is dumped. (S-57 Edition 3.1, Appendix A – Chapter 2, Page 2.29, November 2000).

3) **Nuclear waste dumping ground**

IHO Definition: An area at sea where nuclear waste is dumped. (S-57 Edition 3.1, Appendix A – Chapter 2, Page 2.29, November 2000).

4) Explosives dumping ground

IHO Definition: An area at sea where explosives are dumped. (S-57 Edition 3.1, Appendix A – Chapter 2, Page 2.29, November 2000).

5) Spoil ground

IHO Definition: A sea area where dredged material is deposited. Also called dumping ground. (IHO Dictionary – S-32).

6) Vessel dumping ground

IHO Definition: An area at sea where disused vessels are scuttled. (S-57 Edition 3.1, Appendix A – Chapter 2, Page 2.29, November 2000).

Remarks:

- No remarks.

27.21 Category of fence (CATFNC)

Category of fence: IHO Definition: **Definition required.**

1) Fence

IHO Definition: A man-made barrier of relatively light structure used as an enclosure or boundary. (Defence Geospatial Information Working Group; Feature Data Dictionary Register, 2010).

3) Hedge

IHO Definition: A continuous growth of shrubbery planted as a fence, a boundary or a wind break. (Defence Geospatial Information Working Group; Feature Data Dictionary Register, 2010).

4) Wall

IHO Definition: A solid man-made barrier of generally heavy material used as an enclosure, boundary, or for protection. (Defence Geospatial Information Working Group; Feature Data Dictionary Register, 2010).

Remarks:

- No remarks.

27.22 Category of ferry (CATFRY)

Category of ferry: IHO Definition: **Definition required.**

1) “Free moving” ferry

IHO Definition: A ferry which may have routes that vary with weather, tide and traffic. (S-57 Edition 3.1, Appendix A – Chapter 2, Page 2.32, November 2000).

2) Cable ferry

IHO Definition: A ferry that follows a fixed route guided by a cable. (S-57 Edition 3.1, Appendix A – Chapter 2, Page 2.32, November 2000).

3) Ice ferry

IHO Definition: A winter-time ferry which crosses a lead. (Finnish Maritime Administration).

5) High speed ferry

IHO Definition: **Definition required.**

Remarks:

- The attribute “category of ferry” does not encode the various types of ferry vessel, but the manoeuvrability of the ferry. The value “cable ferry” indicates a ferry that follows a fixed route guided by a cable. A cable ferry may hinder the flow of other traffic.

27.23 Category of fishing facility (CATFIF)

Category of fishing facility: IHO Definition: Definition required.

1) **Fishing stake**

IHO Definition: A pole or stake placed in shallow water to outline a fishing ground or to catch fish. (IHO Dictionary – S-32).

2) **Fish trap**

IHO Definition: A structure (usually portable) for catching fish. (Adapted from IHO Dictionary – S-32).

3) **Fish weir**

IHO Definition: A fence of stakes or stones set in a river or along the shore to trap fish. (Adapted from IHO Dictionary – S-32).

4) **Tunny net**

IHO Definition: A net built at sea for catching tunny. (IHO Dictionary – S-32).

Remarks:

- No remarks.

27.24 Category of fog signal (CATFOG)

Category of fog signal: IHO Definition: Definition required.

1) **Explosive**

IHO Definition: A signal produced by the firing of explosive charges. (Admiralty List of Lights and Fog Signals).

2) **Diaphone**

IHO Definition: A diaphone uses compressed air and generally emits a powerful low-pitched sound, which often concludes with a brief sound of suddenly lowered pitch, termed the “grunt”. (Admiralty List of Lights and Fog Signals).

3) **Siren**

IHO Definition: A siren uses compressed air and exists in a variety of types which differ considerably in their sound and power. (Admiralty List of Lights and Fog Signals).

4) **Nautophone**

IHO Definition: A horn having a diaphragm oscillated by electricity (IHO Dictionary – S-32).

5) **Reed**

IHO Definition: A reed uses compressed air and emits a weak, high pitched sound. (Admiralty List of Lights and Fog Signals).

6) **Tyfon**

IHO Definition: A diaphragm horn which operates under the influence of compressed air or steam (IHO Dictionary – S-32).

7) **Bell**

IHO Definition: A ringing sound with a short range. The apparatus may be operated automatically, by hand or by wave action. (S-57 Edition 3.1, Appendix A – Chapter 2, Page 2.34, November 2000).

8) **Whistle**

IHO Definition: A distinctive sound made by a jet of air passing through an orifice. The apparatus may be operated automatically, by hand or by air being forced up a tube by waves acting on a buoy. (S-57 Edition

3.1, Appendix A – Chapter 2, Page 2.34, November 2000).

9) **Gong**

IHO Definition: A sound produced by vibration of a disc when struck. The apparatus may be operated automatically, by hand or by wave action. (S-57 Edition 3.1, Appendix A – Chapter 2, Page 2.34, November 2000).

10) **Horn**

IHO Definition: A horn uses compressed air or electricity to vibrate a diaphragm and exists in a variety of types which differ greatly in their sound and power. (Admiralty List of Lights and Fog Signals).

Remarks:

- The attribute “category of fog signal” encodes the various means of generating the signal. The classification “horn” is the generic term for fog signals “nautophone”, “reed” and “tyfon”.

27.25 Category of fortified structure (CATFOR)

Category of fortified structure: IHO Definition: Definition required.

1) **Castle**

IHO Definition: A large fortified building or structure. (Adapted from The Collins Dictionary).

2) **Fort**

IHO Definition: A fortified enclosure, building, or position able to be defended against an enemy. (The Collins Dictionary).

3) **Battery**

IHO Definition: A fortified structure on which artillery is mounted. (The Collins Dictionary).

4) **Blockhouse**

IHO Definition: A concrete structure strengthened to give protection against enemy fire, with apertures to allow defensive gunfire. (The Collins Dictionary).

5) **Fortified tower**

IHO Definition: A small circular fort with very thick walls (for example Martello tower). (Adapted from Defence Geospatial Information Working Group; Feature Data Dictionary Register, 2010).

6) **Redoubt**

IHO Definition: An outwork or fieldwork usually square or polygonal and without flanking defences. (Concise Oxford Dictionary).

8) **Fortified submarine shelter**

IHO Definition: Definition required.

9) **Rampart**

IHO Definition: Definition required.

Remarks:

- No remarks.

27.26 Category of gate (CATGAT)

Category of gate: IHO Definition: Definition required.

2) **Flood barrage gate**

IHO Definition: An opening gate used to control flood water. (Defence Geospatial Information Working Group; Feature Data Dictionary Register, 2010).

3) **Caisson**

IHO Definition: A steel structure used for closing the entrance of locks, wet and dry docks. (IHO Dictionary – S-32).

4) **Lock gate**

IHO Definition: The massive hinged doors at each end of a lock. (Adapted from IHO Dictionary – S-32).

5) **Dyke gate**

IHO Definition: An opening gate in a dyke. (Defence Geospatial Information Working Group; Feature Data Dictionary Register, 2010).

6) **Sluice**

IHO Definition: A sliding gate or other contrivance for changing the level of a body of water by controlling the flow into or out of it. (IHO Dictionary – S-32).

Remarks:

- No remarks.

27.27 Category of harbour facility (CATHAF)

Category of harbour facility: IHO Definition: **Definition required.**

1) **RoRo terminal**

IHO Definition: A terminal for roll-on roll-off ferries. (S-57 Edition 3.1, Appendix A – Chapter 2, Page 2.38, November 2000).

3) **Ferry terminal**

IHO Definition: A terminal for passenger and vehicle ferries. (S-57 Edition 3.1, Appendix A – Chapter 2, Page 2.38, November 2000).

4) **Fishing harbour**

IHO Definition: A harbour with facilities for fishing boats. (S-57 Edition 3.1, Appendix A – Chapter 2, Page 2.38, November 2000).

5) **Yacht harbour/marina**

IHO Definition: A harbour facility for small boats, yachts, etc., where supplies, repairs, and various services are available. (IHO Dictionary – S-32).

6) **Naval base**

IHO Definition: A centre of operations for naval vessels. (Adapted from The Collins Dictionary).

7) **Tanker terminal**

IHO Definition: A terminal for the bulk handling of liquid cargoes. (S-57 Edition 3.1, Appendix A – Chapter 2, Page 2.38, November 2000).

8) **Passenger terminal**

IHO Definition: A terminal for the loading and unloading of passengers. (S-57 Edition 3.1, Appendix A – Chapter 2, Page 2.38, November 2000).

9) **Shipyard**

IHO Definition: A place where ships are built or repaired (IHO Dictionary – S-32).

10) **Container terminal**

IHO Definition: A terminal with facilities to load/unload or store shipping containers. (S-57 Edition 3.1, Appendix A – Chapter 2, Page 2.38, November 2000, as amended).

11) **Bulk terminal**

IHO Definition: A terminal for the handling of bulk materials such as iron ore, coal, etc. (S-57 Edition 3.1, Appendix A – Chapter 2, Page 2.38, November 2000).

12) **Ship lift**

IHO Definition: A platform powered by synchronous electric motors (for example syncrolift) used to lift vessels (larger than boats) in and out of the water. (Adapted from S-57 Edition 3.1, Appendix A – Chapter 2, Page 2.38, November 2000).

13) **Straddle carrier**

IHO Definition: A wheeled vehicle designed to lift and carry containers or vessels within its own framework. It is used for moving, and sometimes stacking, shipping containers and vessels. (S-57 Edition 3.1, Appendix A – Chapter 2, Page 2.39, November 2000).

14) **Service harbour**

IHO Definition: A harbour within which the floating equipment (dredges, tugs ...) of harbour services are stationed.

15) **Pilotage service**

IHO Definition: Definition required.

Remarks:

- No remarks.

27.28 Category of hulk (CATHLK)

Category of hulk: IHO Definition: Definition required.

1) **Floating restaurant**

IHO Definition: A permanently moored floating structure (for example: an old ship) that is used as a restaurant. (Defence Geospatial Information Working Group; Feature Data Dictionary Register, 2010).

2) **Historic ship**

IHO Definition: A ship of historical interest permanently moored as a tourist attraction. (Defence Geospatial Information Working Group; Feature Data Dictionary Register, 2010).

3) **Floating museum**

IHO Definition: A permanently moored floating structure (for example: an old ship) that is used as a museum. (Defence Geospatial Information Working Group; Feature Data Dictionary Register, 2010).

4) **Floating accommodation**

IHO Definition: A permanently moored floating structure (for example: an old ship) that is used for accommodation. (Defence Geospatial Information Working Group; Feature Data Dictionary Register, 2010).

5) **Floating breakwater**

IHO Definition: A permanently moored floating structure, often constructed from old ships, used as a breakwater. (S-57 Edition 3.1, Appendix A – Chapter 2, Page 2.40, November 2000).

6) **Casino**

IHO Definition: A permanently moored floating structure, that keeps on taking my money. (Australian Hydrographic Service).

7) **Training vessel**

IHO Definition: A permanently moored floating structure, often constructed from old ships, used ????????. (?????????).

Remarks:

- No remarks.

27.29 Category of ice (CATICE)

Category of ice: IHO Definition: Definition required.

1) Fast Ice

IHO Definition: Sea ice which remains fast, generally in the position where originally formed, and which may attain a considerable thickness. It is found along coasts, where it is attached to the shore, or over shoals, where it may be held in position by islands, grounded icebergs or grounded polar ice. (IHO Dictionary – S-32).

5) Glacier

IHO Definition: A mass of snow and ice continuously moving from higher to lower ground or, if afloat, continuously spreading. (IHO Dictionary – S-32).

8) Polar ice

IHO Definition: Sea ice that is more than one year old (in contrast to winter ice). The WMO code defines polar ice as any sea ice more than one year old and more than 3 metres thick. (IHO Dictionary – S-32).

Remarks:

- No remarks.

27.30 Category of installation buoy (CATINB)

Category of installation buoy: IHO Definition: Definition required.

1) Catenary anchor leg mooring (CALM)

IHO Definition: Incorporates a large buoy which remains on the surface at all times and is moored by 4 or more anchors. Mooring hawsers and cargo hoses lead from a turntable on top of the buoy, so that the buoy does not turn as the ship swings to wind and stream. (S-57 Edition 3.1, Appendix A – Chapter 2, Page 2.42, November 2000).

2) Single buoy mooring (SBM)

IHO Definition: A mooring structure used by tankers to load and unload in port approaches or in offshore oil and gas fields. The size of the structure can vary between a large mooring buoy and a manned floating structure. Also known as single point mooring (SPM) (IHO Dictionary – S-32).

Remarks:

- No remarks.

27.31 Category of land region (CATLND)

Category of land region: IHO Definition: Definition required.

1) Fen

IHO Definition: A type of bog, especially a low-lying area, wholly or partly covered with water and dominated by grasslike plants, grasses, sedges and reeds. (The New Encyclopaedia Britannica, 15th Edition 1991).

2) Marsh

IHO Definition: An area of wet, often spongy ground that is subject to frequent flooding or tidal inundations, but not considered to be continually under water. It is characterized by the growth of non woody plants and by the lack of trees. (Nautical Chart Manual, US National Oceanic and Atmospheric Administration - NOAA, 1992).

3) Moor/bog

IHO Definition: Wet spongy ground consisting of decaying vegetation, which retains stagnant water, too soft to bear the weight of any heavy body. (IHO Dictionary – S-32).

4) **Heathland**

IHO Definition: A tract of wasteland; peat bog, usually covered by a low scrubby growth, but may have scattered small open water holes. (Nautical Chart Manual, US National Oceanic and Atmospheric Administration - NOAA, 1992).

5) **Mountain range**

IHO Definition: A series of connected and aligned mountains or mountain ridges. (US National Oceanic and Atmospheric Administration - NOAA, 1992).

6) **Lowlands**

IHO Definition: Low and relatively level land at a lower elevation than adjoining areas. (US National Oceanic and Atmospheric Administration - NOAA, 1992).

7) **Canyon lands**

IHO Definition: A relatively narrow, deep depression with steep sides, the bottom of which generally has a continuous slope. (IHO Dictionary – S-32).

8) **Paddy field**

IHO Definition: A piece of land set aside for crops which are periodically flooded (for example rice paddy). (S-57 Edition 3.1, Appendix A – Chapter 2, Page 2.44, November 2000).

9) **Agricultural land**

IHO Definition: Of or pertaining to the science or practice of cultivating the soil and rearing animals. (Defence Geospatial Information Working Group; Feature Data Dictionary Register, 2010).

10) **Savanna/grassland**

IHO Definition: An open grassy plain with few or no trees in a tropical or subtropical region; a tract covered mainly by grasses that have little or no woody tissue. (Defence Geospatial Information Working Group; Feature Data Dictionary Register, 2010).

11) **Parkland**

IHO Definition: A piece of ground kept for ornament and/or recreation or maintained in its natural state as a public property or area. (Websters New Collegiate Dictionary 1975).

12) **Swamp**

IHO Definition: An area of spongy land saturated with water. It may have a shallow covering of water, usually with a considerable amount of vegetation appearing above the surface. (IHO Dictionary – S-32).

13) **Landslide**

IHO Definition: (or landslip). The sliding down of a mass of land on a mountain or cliff-side; land which has so fallen. (IHO Dictionary – S-32).

14) **Lava flow**

IHO Definition: The substance that results from the cooling of molten rock. (Adapted from IHO Dictionary – S-32).

15) **Salt pan**

IHO Definition: Shallow pools of brackish water used for the natural evaporation of sea water to obtain salt. (IHO Dictionary – S-32).

16) **Moraine**

IHO Definition: Any accumulation of loose material deposited by a glacier. (Marine Chart Manual, US National Oceanic and Atmospheric Administration - NOAA, 1992).

17) **Crater**

IHO Definition: Bowl-shaped cavity, at the summit or on the side of a volcano. (IHO Dictionary – S-32).

Also a hole formed by the impact of a meteor. (Nautical Chart Manual, US National Oceanic and Atmospheric Administration - NOAA, 1992).

18) **Cave**

IHO Definition: A natural underground chamber or series of chambers open to the surface. (Merriam-Webster On-line Dictionary, March 2010).

19) **Rock column or pinnacle**

IHO Definition: Any high tower or spire-shaped pillar of rock, alone or cresting a summit. (IHO Dictionary – S-32).

20) **Cay**

IHO Definition: A small insular feature usually with scant vegetation; usually of sand or coral. Often applied to smaller coral shoals. (United Kingdom Hydrographic Office – UKHO – The Mariners Handbook).

Remarks:

- The attribute “category of land region” encodes general terms for describing landscapes.

27.32 Category of landmark (CATLMK)

Category of landmark: IHO Definition: **Definition required.**

1) **Cairn**

IHO Definition: A mound of stones, usually conical or pyramidal, raised as a landmark or to designate a point of importance in surveying. (IHO Dictionary – S-32).

2) **Cemetery**

IHO Definition: A site and associated structures devoted to the burial of the dead. (Defence Geospatial Information Working Group; Feature Data Dictionary Register, 2010).

3) **Chimney**

IHO Definition: A vertical structure containing a passage or flue for discharging smoke and gases of combustion. (Defence Geospatial Information Working Group; Feature Data Dictionary Register, 2010).

4) **Dish aerial**

IHO Definition: A parabolic aerial for the receipt and transmission of high frequency radio signals. (IHO Dictionary – S-32).

5) **Flagstaff (flagpole)**

IHO Definition: A staff or pole on which a flag is raised. (Defence Geospatial Information Working Group; Feature Data Dictionary Register, 2010).

6) **Flare stack**

IHO Definition: A tall structure used for burning-off waste oil or gas. (IHO Dictionary – S-32). Normally showing a flame and located at refineries. (S-57 Edition 3.1, Appendix A – Chapter 2, Page 2.45, November 2000).

7) **Mast**

IHO Definition: A relatively tall structure usually held vertical by guy lines. (S-57 Edition 3.1, Appendix A – Chapter 2, Page 2.45, November 2000).

8) **Windsock**

IHO Definition: A tapered fabric sleeve mounted so as to catch and swing with the wind, thus indicating the wind direction. (Navigation Dictionary, US National Oceanic and Atmospheric Administration - NOAA, 1969).

9) **Monument**

IHO Definition: A marker erected and/or maintained as a memorial to a person and/or event. (Defence

Geospatial Information Working Group; Feature Data Dictionary Register, 2010).

10) **Column (pillar)**

IHO Definition: A cylindrical or slightly tapering body of considerably greater length than diameter erected vertically. (Oxford English Dictionary).

11) **Memorial plaque**

IHO Definition: A slab of metal, usually ornamented, erected as a memorial to a person or event. (S-57 Edition 3.1, Appendix A – Chapter 2, Page 2.46, November 2000).

12) **Obelisk**

IHO Definition: A tapering shaft usually of stone or concrete, square or rectangular in section, with a pyramidal apex. (Adapted from Oxford English Dictionary).

13) **Statue**

IHO Definition: A representation of a living being, sculptured, moulded, or cast in a variety of materials (for example: marble, metal, or plaster). (Defence Geospatial Information Working Group; Feature Data Dictionary Register, 2010).

14) **Cross**

IHO Definition: A monument, or other structure in form of a cross. (Funk & Wagnalls Dictionary).

15) **Dome**

IHO Definition: A landmark comprising a hemispherical or spheroidal shaped structure. (Adapted from the Macquarie Dictionary).

16) **Radar scanner**

IHO Definition: A device used for directing a radar beam through a search pattern. (Adapted from Navigation Dictionary, US National Oceanic and Atmospheric Administration - NOAA, 1969).

17) **Tower**

IHO Definition: A relatively tall, narrow structure that may either stand alone or may form part of another structure. (Defence Geospatial Information Working Group; Feature Data Dictionary Register, 2010).

18) **Windmill**

IHO Definition: A system of vanes attached to a tower and driven by wind (excluding wind turbines). (Defence Geospatial Information Working Group; Feature Data Dictionary Register, 2010).

20) **Spire/minaret**

IHO Definition: A tall conical or pyramid-shaped structure often built on the roof or tower of a building, especially a church or mosque. (Adapted from The New Shorter Oxford English Dictionary, 1993).

21) **Large rock (or boulder) on land**

IHO Definition: An isolated rocky formation or a single large stone (Adapted from IHO Dictionary – S-32).

22) **Triangulation mark**

IHO Definition: A recoverable point on the earth, whose geographic position has been determined by angular methods with geodetic instruments. A triangulation point is a selected point, which has been marked with a station mark, or it is a conspicuous natural or artificial feature. Also called trigonometric station or triangulation station. (IHO Dictionary – S-32).

23) **Boundary mark**

IHO Definition: A marker identifying the location of a surveyed boundary line. (Defence Geospatial Information Working Group; Feature Data Dictionary Register, 2010).

24) **Observation wheel**

IHO Definition: A bloody big Ferris Wheel. (Australian Hydrographic Service).

25) Torii

IHO Definition: A gate located in a Shinto shrine.

Remarks:

- No remarks.

27.33 Category of lateral mark (CATLAM)

Category of lateral mark: IHO Definition: **Definition required.**

1) Port-hand lateral mark

IHO Definition: Indicates the port boundary of a navigational channel or suggested route when proceeding in the “conventional direction of buoyage”. (S-57 Edition 3.1, Appendix A – Chapter 2, Page 2.47, November 2000).

2) Starboard-hand lateral mark

IHO Definition: Indicates the starboard boundary of a navigational channel or suggested route when proceeding in the “conventional direction of buoyage”. (S-57 Edition 3.1, Appendix A – Chapter 2, Page 2.47, November 2000).

3) Preferred channel to starboard lateral mark

IHO Definition: At a point where a channel divides, when proceeding in the “conventional direction of buoyage”, the preferred channel (or primary route) is indicated by a modified port-hand lateral mark. (S-57 Edition 3.1, Appendix A – Chapter 2, Page 2.47, November 2000).

4) Preferred channel to port lateral mark

IHO Definition: At a point where a channel divides, when proceeding in the “conventional direction of buoyage”, the preferred channel (or primary route) is indicated by a modified starboard-hand lateral mark. (S-57 Edition 3.1, Appendix A – Chapter 2, Page 2.47, November 2000).

Remarks:

- There are two international buoyage regions, A and B, between which lateral marks differ. The buoyage region is encoded using the separate attribute **marks navigational – system of** (see clause X.X). When retroreflectors and/or lights are fitted to these marks, they are encoded as separate features.
- The “conventional direction of buoyage” may be either the general direction taken by the mariner when approaching a harbour, river, estuary or other waterway from seaward, or the direction determined by the proper authority, which in principle follows a clockwise direction around land masses.

27.34 Category of light (CATLIT)

Category of light: IHO Definition: **Definition required.**

4) Leading light

IHO Definition: A light associated with other lights so as to form a leading line to be followed. (Adapted from IHO Dictionary – S-32).

5) Aero light

IHO Definition: An aero light is established for aeronautical navigation and may be of higher power than marine lights and visible from well offshore. (S-57 Edition 3.1, Appendix A – Chapter 2, Page 2.48, November 2000).

8) Flood light

IHO Definition: A broad beam light used to illuminate a structure or area. (Adapted from The Collins Dictionary).

9) Strip light

IHO Definition: A light whose source has a linear form generally horizontal, which can reach a length of

several metres. (S-57 Edition 3.1, Appendix A – Chapter 2, Page 2.48, November 2000).

10) **Subsidiary light**

IHO Definition: A light placed on or near the support of a main light and having a special use in navigation. (Admiralty List of Radio Signals, UK Hydrographic Office).

11) **Spotlight**

IHO Definition: A powerful light focused so as to illuminate a small area. (The Collins Dictionary).

12) **Front**

IHO Definition: Term used with leading lights to describe the position of the light on the lead as viewed from seaward. (S-57 Edition 3.1, Appendix A – Chapter 2, Page 2.49, November 2000).

13) **Rear**

IHO Definition: Term used with leading lights to describe the position of the light on the lead as viewed from seaward. (S-57 Edition 3.1, Appendix A – Chapter 2, Page 2.49, November 2000).

14) **Lower**

IHO Definition: Term used with leading lights to describe the position of the light on the lead as viewed from seaward. (S-57 Edition 3.1, Appendix A – Chapter 2, Page 2.49, November 2000).

15) **Upper**

IHO Definition: Term used with leading lights to describe the position of the light on the lead as viewed from seaward. (S-57 Edition 3.1, Appendix A – Chapter 2, Page 2.49, November 2000).

17) **Emergency**

IHO Definition: A light available as a backup to a main light which will be illuminated should the main light fail. (S-57 Edition 3.1, Appendix A – Chapter 2, Page 2.49, November 2000).

18) **Bearing light**

IHO Definition: A light which enables its approximate bearing to be obtained without the use of a compass. (S-57 Edition 3.1, Appendix A – Chapter 2, Page 2.49, November 2000).

19) **Horizontally disposed**

IHO Definition: A group of lights of identical character and almost identical position, that are disposed horizontally. (S-57 Edition 3.1, Appendix A – Chapter 2, Page 2.49, November 2000).

20) **Vertically disposed**

IHO Definition: A group of lights of identical character and almost identical position, that are disposed vertically. (S-57 Edition 3.1, Appendix A – Chapter 2, Page 2.49, November 2000).

Remarks:

- Marine light (a light intended primarily for marine navigation) is not included in the above list. All lights are considered to be marine lights unless the attribute “category of light” indicates otherwise.

27.35 Category of marine farm/culture (CATMFA)

Category of marine farm/culture: IHO Definition: **Definition required.**

1) **Crustaceans**

IHO Definition: Hard shelled animals, for example crabs or lobsters. (S-57 Edition 3.1, Appendix A – Chapter 2, Page 2.50, November 2000).

2) **Edible bivalve molluscs**

IHO Definition: Oysters, mussels, scallops (S-57 Edition 3.1, Appendix A – Chapter 2, Page 2.50, November 2000, as amended).

3) **Fish**

IHO Definition: Vertebrate cold blooded animal with gills, living in water. (S-57 Edition 3.1, Appendix A – Chapter 2, Page 2.50, November 2000).

4) **Seaweed**

IHO Definition: The general name for marine plants of the Algae class which grow in long narrow ribbons. (International Maritime Dictionary, 2nd Ed.).

5) **Pearl culture farm**

IHO Definition: An area where pearls are artificially cultivated. (S-57 Edition 3.1, Appendix A – Chapter 2, Page 2.50, November 2000).

Remarks:

- No remarks.

27.36 Category of military practice area (CATMPA)

Category of military practice area: IHO Definition: **Definition required.**

2) **Torpedo exercise area**

IHO Definition: An area within which exercises are carried out with torpedoes. (S-57 Edition 3.1, Appendix A – Chapter 2, Page 2.52, November 2000).

3) **Submarine exercise area**

IHO Definition: An area within which submarine exercises are carried out. (S-57 Edition 3.1, Appendix A – Chapter 2, Page 2.52, November 2000).

4) **Firing danger area**

IHO Definition: Areas for bombing and missile exercises. (S-57 Edition 3.1, Appendix A – Chapter 2, Page 2.52, November 2000).

5) **Mine-laying practice area**

IHO Definition: An area within which mine laying exercises are carried out. (S-57 Edition 3.1, Appendix A – Chapter 2, Page 2.52, November 2000).

6) **Small arms firing range**

IHO Definition: An area for shooting pistols, rifles and machine guns etc. at a target. (S-57 Edition 3.1, Appendix A – Chapter 2, Page 2.52, November 2000).

Remarks:

- No remarks.

27.37 Category of mooring/warping facility (CATMOR)

Category of mooring/warping facility: IHO Definition: **Definition required.**

1) **Dolphin**

IHO Definition: A post or group of posts, which may support a deck, used for mooring or warping a vessel. (Adapted from IHO Dictionary – S-32).

2) **Deviation dolphin**

IHO Definition: A post or group of posts, which a vessel may swing around for compass adjustment. (Defence Geospatial Information Working Group; Feature Data Dictionary Register, 2010).

3) **Bollard**

IHO Definition: Small shaped post, mounted on a wharf or dolphin used to secure ship's lines. (IHO Dictionary – S-32).

4) Tie-up wall

IHO Definition: A section of wall designated for tying-up vessels awaiting transit. Bollards and mooring devices are available for both large and small ships. (Defence Geospatial Information Working Group; Feature Data Dictionary Register, 2010).

5) Post or pile

IHO Definition: A long heavy timber or section of steel, wood, concrete, etc., forced into the seabed to serve as a mooring facility. (Adapted from IHO Dictionary – S-32).

6) Chain/wire/cable

IHO Definition: A chain or very strong fibre or wire rope connecting two independent features (for example a buoy and pile or two buoys) used to anchor or moor vessels or buoys. (Adapted from IHO Dictionary – S-32).

7) Mooring buoy

IHO Definition: A buoy secured to the bottom by permanent moorings with means for mooring a vessel by use of its anchor chain or mooring lines. (IHO Dictionary – S-32).

Remarks:

- No remarks.

27.38 Category of navigation line (CATNAV)

Category of navigation line: IHO Definition: Definition required.

1) Clearing line

IHO Definition: A straight line that marks the boundary between a safe and a dangerous area or that passes clear of a navigational danger. (Adapted from IHO Dictionary, S-32).

2) Transit line

IHO Definition: A line passing through one or more fixed marks. (S-57 Edition 3.1, Appendix A – Chapter 2, Page 2.55, November 2000).

3) Leading line bearing a recommended track

IHO Definition: A line passing through one or more clearly defined features, along the path of which a vessel can approach safely up to a certain distance off. (Adapted from IHO Dictionary, S-32).

Remarks:

- No remarks.

27.39 Category of obstruction (CATOBS)

Category of obstruction: IHO Definition: Definition required.

1) Snag/stump

IHO Definition: A tree, branch or broken pile embedded in the ocean floor, river or lake bottom and not visible on the surface, forming thereby a hazard to vessels. (IHO Dictionary – S-32).

2) Wellhead

IHO Definition: A submarine structure projecting some distance above the seabed and capping a temporarily abandoned or suspended oil or gas well. (IHO Dictionary – S-32).

3) Diffuser

IHO Definition: A structure on an outfall through which liquids are discharged. The structure will usually project above the level of the outfall and can be an obstruction to navigation. (S-57 Edition 3.1, Appendix A – Chapter 2, Page 2.56, November 2000).

4) Crib

IHO Definition: A permanent structure set in the water, framed with wooden beams and filled with rocks or boulders. They are used to anchor log booms or support other constructions, for example submerged outfalls, diffusers etc. They may always be dry, submerged or cover and uncover. (S-57 Edition 3.1, Appendix A – Chapter 2, Page 2.56, November 2000).

5) Fish haven

IHO Definition: Areas established by private interests, usually sport fishermen, to simulate natural reefs and wrecks that attract fish. The reefs are constructed by dumping assorted junk in areas which may be of very small extent or may stretch a considerable distance along a depth contour. Also called fishery reefs. (S-57 Edition 3.1, Appendix A – Chapter 2, Page 2.56, November 2000).

6) Foul area

IHO Definition: An area of numerous unidentified dangers to navigation. The area serves as a warning to the mariner that all dangers are not identified individually and that navigation through the area may be hazardous. Commonly used to encode areas behind danger lines on nautical charts. (Adapted from IHO Dictionary – S-32).

8) Ice boom

IHO Definition: Floating barriers, anchored to the bottom, used to deflect the path of floating ice in order to prevent the obstruction of locks, intakes, etc., and to prevent damage to bridge piers and other structures. (Canadian Hydrographic Service, Chart specifications).

9) Ground tackle

IHO Definition: Equipment such as anchors, concrete blocks, chains and cables, etc., used to position floating structures such as trot and mooring buoys etc. (S-57 Edition 3.1, Appendix A – Chapter 2, Page 2.57, November 2000).

10) Boom

IHO Definition: A floating barrier used to protect a river or harbour mouth or to create a sheltered area for storage purposes. (IHO Dictionary – S-32).

12) Wave energy device

IHO Definition: Definition required.

13) Subsurface ocean data acquisition system (ODAS)

IHO Definition: Definition required.

14) Artificial reef

IHO Definition: Definition required.

15) Template

IHO Definition: Definition required.

16) Manifold

IHO Definition: Definition required.

17) Submerged pingo

IHO Definition: Definition required.

18) Remains of platform

IHO Definition: Definition required.

19) Scientific instrument

IHO Definition: Definition required.

20) Underwater turbine

IHO Definition: Any of various machines having a rotor, usually with vanes or blades, driven by the

pressure, momentum, or reactive thrust of a moving fluid, as steam, water, hot gases, or air, either occurring in the form of free jets or as a fluid passing through and entirely filling a housing around the rotor and is located underwater.

Remarks:

- No remarks.

27.40 Category of offshore platform (CATOFFP)

Category of offshore platform: IHO Definition: Definition required.

1) **Oil derrick/rig**

IHO Definition: A temporary mobile structure, either fixed or floating, used in the exploration stages of oil and gas fields. (IHO Dictionary – S-32).

2) **Production platform**

IHO Definition: A term used to indicate a permanent offshore structure equipped to control the flow of oil or gas. It does not include entirely submarine structures. (Adapted from IHO Dictionary – S-32).

3) **Observation/research platform**

IHO Definition: A platform from which one's surroundings or events can be observed, noted or recorded such as for scientific study. (Adapted from IHO Dictionary – S-32, Edition 5).

4) **Articulated loading platform (ALP)**

IHO Definition: A metal lattice tower, buoyant at one end and attached at the other by a universal joint to a concrete filled base on the seabed. The platform may be fitted with a helicopter platform, emergency accommodation and hawser/hose retrieval. (Adapted from United Kingdom Hydrographic Office CSDO 607.2 (12), May 1994).

5) **Single anchor leg mooring (SALM)**

IHO Definition: A rigid frame or tube with a buoyancy device at its upper end, secured at its lower end to a universal joint on a large steel or concrete base resting on the seabed, and at its upper end to a mooring buoy by a chain or wire. (Adapted from United Kingdom Hydrographic Office CSDO 607.2 (12), May 1994).

6) **Mooring tower**

IHO Definition: A platform secured to the seabed and surmounted by a turntable to which ships moor. (Adapted from United Kingdom Hydrographic Office CSDO 607.2 (12), May 1994).

7) **Artificial island**

IHO Definition: A man-made structure usually built for the exploration or exploitation of marine resources, marine scientific research, tidal observations, etc. (Adapted from IHO Dictionary – S-32).

8) **Floating production, storage and off-loading vessel (FPSO)**

IHO Definition: An offshore facility consisting of a moored tanker/barge by which the product is extracted, stored or exported. (Adapted from United Kingdom Hydrographic Office CSDO 607.2 (13), May 1994).

9) **Accommodation platform**

IHO Definition: A platform used primarily for eating, sleeping and recreation purposes. (S-57 Edition 3.1, Appendix A – Chapter 2, Page 2.59, November 2000).

10) **Navigation, communication and control buoy (NCCB)**

IHO Definition: A floating structure with control room, power and storage facilities, attached to the seabed by a flexible pipeline and cables. (S-57 Edition 3.1, Appendix A – Chapter 2, Page 2.59, November 2000).

11) **Floating oil tank**

IHO Definition: Definition required.

Remarks:

- No remarks.

27.41 Category of offshore production area (CATPRA)

Category of offshore production area: IHO Definition: **Definition required.**

1) Offshore wind farm

IHO Definition: A collection of wind turbines that are collocated and are organized as a single power generation unit. (Adapted from Defence Geospatial Information Working Group; Feature Data Dictionary Register, 2010).

2) Wave farm

IHO Definition: A collection of collocated devices which harness wave energy and are organized as a single power generation unit. (Adapted from Defence Geospatial Information Working Group; Feature Data Dictionary Register, 2010).

3) Current farm

IHO Definition: A collection of collocated devices which harness tidal energy and are organized as a single power generation unit. (Adapted from Defence Geospatial Information Working Group; Feature Data Dictionary Register, 2010).

4) Tank farm

IHO Definition: A collection of collocated large-capacity tanks in which petroleum, natural gas, or liquid petrochemicals are stored. (Adapted from Defence Geospatial Information Working Group; Feature Data Dictionary Register, 2010).

5) Seabed material extraction area

IHO Definition: An area in which materials forming, or under, the seabed are removed.

Remarks:

- No remarks.

27.42 Category of oil barrier (CATOLB)

Category of oil barrier: IHO Definition: **Definition required.**

1) Oil retention (high pressure pipe)

IHO Definition: A pipe with holes from which air blows. When the air bubbles reach the surface they form a barrier which prevents the spread of oil. (Kort- og Matrikelstyrelsen, Denmark).

2) Floating oil barrier

IHO Definition: A floating tube shaped structure, with a curtain (2 metre) hanging under it, below the surface, which prevents the spread of oil. (Kort- og Matrikelstyrelsen, Denmark).

Remarks:

- No remarks.

27.43 Category of pile (CATPLE)

Category of pile: IHO Definition: **Definition required.**

1) Stake

IHO Definition: An elongated wood or metal pole embedded in the seabed to serve as a marker or support. (Adapted from IHO Dictionary – S-32).

3) Post

IHO Definition: A vertical piece of timber, metal or concrete forced into the earth or seabed. (Defence Geospatial Information Working Group; Feature Data Dictionary Register, 2010).

4) Tripodal

IHO Definition: A single structure comprising 3 or more piles held together (sections of heavy timber, steel or concrete), and forced into the earth or seabed. (Adapted from IHO Dictionary – S-32).

5) Piling

IHO Definition: A number of piles, usually in a straight line, and usually connected or bolted together (Adapted from IHO Dictionary – S-32).

6) Area of piles

IHO Definition: A number of piles, usually in a straight line, but not connected by structural members (Australian Hydrographic Service).

7) Pipe

IHO Definition: Definition required.

Remarks:

- No remarks.

27.44 Category of pilot boarding place (CATPIL)

Category of pilot boarding place: IHO Definition: Definition required.

1) Boarding by pilot-cruising vessel

IHO Definition: Pilot boards from a cruising vessel. (S-57 Edition 3.1, Appendix A – Chapter 2, Page 2.62, November 2000).

2) Boarding by helicopter

IHO Definition: Pilot boards by helicopter which comes out from the shore. (S-57 Edition 3.1, Appendix A – Chapter 2, Page 2.62, November 2000).

3) Pilot comes out from shore

IHO Definition: Pilot boards from a vessel which comes out from the shore on request. (S-57 Edition 3.1, Appendix A – Chapter 2, Page 2.62, November 2000).

Remarks:

- No remarks.

27.45 Category of pipeline/pipe (CATPIP)

Category of pipeline/pipe: IHO Definition: Definition required.

2) Outfall pipe

IHO Definition: A pipe (generally a sewer or drainage pipe) discharging in to the sea or a river. (Defence Geospatial Information Working Group; Feature Data Dictionary Register, 2010).

3) Intake pipe

IHO Definition: A pipe taking water from a river or other body of water, to drive a mill or supply a canal, waterworks, etc. (Adapted from IHO Dictionary – S-32).

4) Sewer

IHO Definition: A pipe in a sewage system for carrying water or sewage to a disposal area. (Defence Geospatial Information Working Group; Feature Data Dictionary Register, 2010).

5) Bubbler system

IHO Definition: A submerged pipe from which warm water bubbles, preventing the surrounding water from freezing. (S-57 Edition 3.1, Appendix A – Chapter 2, Page 2.63, November 2000).

6) Supply pipe

IHO Definition: A pipe used for transport (supply) of gas or liquid product. (Defence Geospatial Information Working Group; Feature Data Dictionary Register, 2010).

Remarks:

- No remarks.

27.46 Category of production area (CATPRA)

Category of production area: IHO Definition: **Definition required.**

1) Quarry

IHO Definition: An open-air excavation for the extraction of stone intended principally for use in construction. (Defence Geospatial Information Working Group; Feature Data Dictionary Register, 2010).

2) Mine

IHO Definition: An excavation made in the terrain for the purpose of extracting and/or exploiting natural resources. (Defence Geospatial Information Working Group; Feature Data Dictionary Register, 2010).

3) Stockpile

IHO Definition: A reserve stock of material, equipment or other supplies. (S-57 Edition 3.1, Appendix A – Chapter 2, Page 2.64, November 2000).

4) Power station area

IHO Definition: A facility including one or more buildings and equipment used for power generation. (Defence Geospatial Information Working Group; Feature Data Dictionary Register, 2010).

5) Refinery area

IHO Definition: A facility where petroleum and/or petroleum products are refined. (Defence Geospatial Information Working Group; Feature Data Dictionary Register, 2010).

6) Timber yard

IHO Definition: An open tract for the storage of wooden lumber and timbers. (Defence Geospatial Information Working Group; Feature Data Dictionary Register, 2010).

7) Factory area

IHO Definition: A group of buildings where goods are manufactured. (S-57 Edition 3.1, Appendix A – Chapter 2, Page 2.64, November 2000).

8) Tank farm

IHO Definition: A collection of collocated large-capacity tanks in which petroleum, natural gas, or liquid petrochemicals are stored. (Adapted from Defence Geospatial Information Working Group; Feature Data Dictionary Register, 2010).

9) Wind farm

IHO Definition: A collection of wind motors that are collocated and are organized as a single power generation unit. (Defence Geospatial Information Working Group; Feature Data Dictionary Register, 2010).

10) Slag heap/spoil heap

IHO Definition: Hill of refuse from a mine, industrial plant etc. on land. (Adapted from Concise Oxford Dictionary).

11) Production plant

IHO Definition: Definition required.

Remarks:

- No remarks.

27.47 Category of pylon (CATPYL)

Category of pylon: IHO Definition: Definition required.

1) Power transmission pylon/pole

IHO Definition: A pylon that supports one or more power lines. (Defence Geospatial Information Working Group; Feature Data Dictionary Register, 2010).

2) Telephone/telegraph pylon/pole

IHO Definition: A pylon that supports one or more communication lines. (Defence Geospatial Information Working Group; Feature Data Dictionary Register, 2010).

3) Aerial cableway/sky pylon

IHO Definition: A tower or pylon supporting steel cables which convey cars, buckets, or other suspended carrier units. (Adapted from Defence Geospatial Information Working Group; Feature and Attribute Coding Catalogue, Edition 1.2).

4) Bridge pylon/tower

IHO Definition: A tower and/or pylon from which the deck of a bridge is suspended. (Defence Geospatial Information Working Group; Feature Data Dictionary Register, 2010).

5) Bridge pier

IHO Definition: A pillar or abutment that supports a bridge span. (Defence Geospatial Information Working Group; Feature Data Dictionary Register, 2010).

Remarks:

- No remarks.

27.48 Category of radar station (CATRAS)

Category of radar station: IHO Definition: Definition required.

1) Radar surveillance station

IHO Definition: A radar station established for traffic surveillance. (IHO Dictionary – S-32)

2) Coast radar station

IHO Definition: A shore-based station which the mariner can contact by radio to obtain a position. (S-57 Edition 3.1, Appendix A – Chapter 2, Page 2.68, November 2000).

Remarks:

- No remarks.

27.49 Category of radar transponder beacon (CATRTB)

Category of radar transponder beacon: IHO Definition: Definition required.

1) Ramark, radar beacon transmitting continuously

IHO Definition: A radar marker beacon which continuously transmits a signal appearing as a radial line on a radar screen, the line indicating the direction of the beacon. Ramarks are intended primarily for marine

use. The name "ramark" is derived from the words radar marker. (IHO Dictionary – S-32).

2) **Racon, radar transponder beacon**

IHO Definition: A radar beacon which returns a coded signal which provides identification of the beacon, as well as range and bearing. The range and bearing are indicated by the location of the first character received on the radar screen. The name "racon" is derived from the words radar beacon. (IHO Dictionary – S-32).

3) **Leading racon/radar transponder beacon**

IHO Definition: A radar beacon that may be used (in conjunction with at least one other radar beacon) to indicate a leading line. (S-57 Edition 3.1, Appendix A – Chapter 2, Page 2.69, November 2000).

Remarks:

- No remarks.

27.50 Category of radio station (CATROS)

Category of radio station: IHO Definition: Definition required.

A radiobeacon is a radio transmitter which emits a distinctive or characteristic signal on which a bearing may be taken. (Adapted from IHO Dictionary, S-32).

5) **Radio direction-finding station**

IHO Definition: A radio station intended to determine only the direction of other stations by means of transmission from the latter. (IHO Dictionary – S-32).

8) **Decca**

IHO Definition: The Decca Navigator System is a high accuracy, short to medium range radio navigational aid intended for coastal and landfall navigation. (Admiralty List of Radio Signals, UK Hydrographic Office, Volume 2, 1994).

9) **Loran C**

IHO Definition: A low frequency electronic position fixing system using pulsed transmissions at 100 Khz. (Admiralty List of Radio Signals, UK Hydrographic Office, Volume 2, 1994).

10) **Differential GNSS**

IHO Definition: A radiobeacon transmitting DGPS correction signals. (S-57 Edition 3.1, Appendix A – Chapter 2, Page 2.71, November 2000).

11) **Toran**

IHO Definition: An electronic position fixing system used mainly by aircraft. (S-57 Edition 3.1, Appendix A – Chapter 2, Page 2.71, November 2000).

12) **Omega**

IHO Definition: A long-range radio navigational aid which operates within the VLF frequency band. The system comprises eight land based stations. (Admiralty List of Radio Signals, UK Hydrographic Office, Volume 2, 1994).

13) **Syledis**

IHO Definition: A ranging position fixing system operating at 420-450MHz over a range of up to 400Km. (S-57 Edition 3.1, Appendix A – Chapter 2, Page 2.71, November 2000).

14) **Chaika (Chayka)**

IHO Definition: A low frequency electronic position fixing system using pulsed transmissions at 100 KHz. (Admiralty List of Radio Signals, UK Hydrographic Office, Volume 2, 1995).

19) **Radio telephone station**

IHO Definition: The equipment needed at one station to carry on two way voice communication by radio

waves only. (Websters New World Dictionary Third College Edition).

20) AIS base station

IHO Definition: Definition required.

Remarks:

- No remarks.

27.51 Category of recommended track (CATTRK)

Category of recommended track: IHO Definition: Definition required.

1) Based on a system of fixed marks

IHO Definition: A straight route (known as a recommended track, range or leading line), which comprises:

- at least two structures (usually beacons or daymarks) and/or natural features, which may carry lights and/or top-marks. The structures/features are positioned so that when observed to be in line, a vessel can follow a known bearing with safety. (adapted from International Association of Lighthouse Authorities - IALA Aids to Navigation Guide, 1990); or
- a single structure or natural feature, which may carry lights and/or a topmark, and a specified bearing which can be followed with safety. (S-57 Edition 3.1, Appendix A – Chapter 2, Page 2.72, November 2000, as amended).

2) Not based on a system of fixed marks

IHO Definition: A route (known as a recommended track or preferred route) which is not based on a single or series of structures or features in line. (S-57 Edition 3.1, Appendix A – Chapter 2, Page 2.72, November 2000).

Remarks:

- No remarks.

27.52 Category of rescue station (CATRSC)

Category of rescue station: IHO Definition: Definition required.

1) Rescue station with lifeboat

IHO Definition: A place where equipment for saving life at sea is maintained; the type of lifeboat may vary from fast, long distance boats to inflatable inshore boats. (S-57 Edition 3.1, Appendix A – Chapter 2, Page 2.74, November 2000).

2) Rescue station with rocket

IHO Definition: Rocket - a pyrotechnic projectile used for signalling or for life-saving purposes. (IHO Dictionary – S-32).

4) Refuge for shipwrecked mariners

IHO Definition: Shelter or protection from danger or distress at sea. (S-57 Edition 3.1, Appendix A – Chapter 2, Page 2.74, November 2000).

5) Refuge for intertidal area walkers

IHO Definition: Shelter or protection from danger in areas exposed to extreme and sudden tides or tidal streams. (S-57 Edition 3.1, Appendix A – Chapter 2, Page 2.74, November 2000).

6) Lifeboat lying at a mooring

IHO Definition: A place where a lifeboat is moored ready for use. (S-57 Edition 3.1, Appendix A – Chapter 2, Page 2.74, November 2000).

7) Aid radio station

IHO Definition: A radio station reserved for emergency situations, might also be a public telephone. (S-57

Edition 3.1, Appendix A – Chapter 2, Page 2.74, November 2000).

8) **First aid equipment**

IHO Definition: A place where first aid equipment is available. (S-57 Edition 3.1, Appendix A – Chapter 2, Page 2.74, November 2000).

Remarks:

- No remarks.

27.53 Category of restricted area (CATREA)

Category of restricted area: IHO Definition: **Definition required.**

1) **Offshore safety zone**

IHO Definition: The area around an offshore installation within which vessels are prohibited from entering without permission. Special regulations protect installations within a safety zone and vessels of all nationalities are required to respect the zone. (IHO Dictionary – S-32, Edition 5).

4) **Nature reserve**

IHO Definition: A tract of land or water managed so as to preserve its flora, fauna, physical features, etc. (S-57 Edition 3.1, Appendix A – Chapter 2, Page 2.75, November 2000, as amended).

5) **Bird sanctuary**

IHO Definition: A place where birds are bred and protected. (S-57 Edition 3.1, Appendix A – Chapter 2, Page 2.75, November 2000).

6) **Game reserve**

IHO Definition: A place where wild animals or birds hunted for sport or food are kept undisturbed for private use. (S-57 Edition 3.1, Appendix A – Chapter 2, Page 2.75, November 2000).

7) **Seal sanctuary**

IHO Definition: A place where seals are protected. (S-57 Edition 3.1, Appendix A – Chapter 2, Page 2.75, November 2000).

8) **Degaussing range**

IHO Definition: An area, usually about two cables diameter, within which ships' magnetic fields may be measured; sensing instruments and cables are installed on the seabed in the range and there are cables leading from the range to a control position ashore. (S-57 Edition 3.1, Appendix A – Chapter 2, Page 2.76, November 2000).

9) **Military area**

IHO Definition: An area controlled by the military in which restrictions may apply. (Hydrographic Service, Royal Australian Navy).

10) **Historic wreck area**

IHO Definition: An area around certain wrecks of historical importance to protect the wrecks from unauthorized interference by diving, salvage or deposition (including anchoring). (S-57 Edition 3.1, Appendix A – Chapter 2, Page 2.76, November 2000).

12) **Navigational aid safety zone**

IHO Definition: An area around a navigational aid which vessels are prohibited from entering. (S-57 Edition 3.1, Appendix A – Chapter 2, Page 2.76, November 2000).

14) **Minefield**

IHO Definition: An area laid and maintained with explosive mines for defence or practice purposes. (S-57 Edition 3.1, Appendix A – Chapter 2, Page 2.76, November 2000).

18) **Swimming area**

IHO Definition: An area in which people may swim and therefore vessel movement may be restricted. (S-57 Edition 3.1, Appendix A – Chapter 2, Page 2.76, November 2000).

19) **Waiting area**

IHO Definition: An area reserved for vessels waiting to enter a harbour. (S-57 Edition 3.1, Appendix A – Chapter 2, Page 2.76, November 2000).

20) **Research area**

IHO Definition: An area where marine research takes place. (S-57 Edition 3.1, Appendix A – Chapter 2, Page 2.76, November 2000).

21) **Dredging area**

IHO Definition: An area where dredging is taking place. (S-57 Edition 3.1, Appendix A – Chapter 2, Page 2.76, November 2000).

22) **Fish sanctuary**

IHO Definition: A place where fish (including shellfish and crustaceans) are protected. (S-57 Edition 3.1, Appendix A – Chapter 2, Page 2.76, November 2000, as amended).

23) **Ecological reserve**

IHO Definition: A tract of land or water managed so as to preserve the relation of plants and living creatures to each other and to their surroundings. (S-57 Edition 3.1, Appendix A – Chapter 2, Page 2.76, November 2000, as amended).

24) **No wake area**

IHO Definition: An area in which a vessels' speed must be reduced in order to reduce the size of the wake it produces. (S-57 Edition 3.1, Appendix A – Chapter 2, Page 2.76, November 2000).

25) **Swinging area**

IHO Definition: An area where vessels turn. (Service Hydrographique et Océanographique de la Marine, France).

27) **Environmentally sensitive sea area**

IHO Definition: A generic term which may be used to describe a wide range of areas, considered sensitive for a variety of environmental reasons. (IHO Chart Specifications, S-4).

28) **Particularly sensitive sea area**

IHO Definition: An area that needs special protection through action by IMO because of its significance for regional ecological, socio-economic or scientific reasons and because it may be vulnerable to damage by international shipping activities. (IHO Chart Specifications, S-4).

29) **Disengagement area**

IHO Definition: An area near a fairway where vessels can go to clear the way or make an about turn and possibly return to a waiting area when the nautical conditions impose it.

30) **Port security area**

IHO Definition: **Definition required.**

31) **Coral sanctuary**

IHO Definition: A place where coral is protected.

32) **Recreation area**

IHO Definition: An area within which recreational activities regularly take place and therefore vessel movement may be restricted. (Adapted from S-57 Edition 3.1, Appendix A – Chapter 2, Page 2.76, November 2000).

Remarks:

- The official legal status of each kind of restricted area defines the kind of restriction(s), for example the restriction for a “game preserve” may be “entering prohibited”, the restriction for an “anchoring prohibition

area” is “anchoring prohibited”.

27.54 Category of road (CATROD)

Category of road: IHO Definition: **Definition required.**

1) Motorway

IHO Definition: A limited access dual carriageway road specially designed for fast long-distance traffic and subject to special regulations concerning its use. It may have more than two lanes. (Adapted from Defence Geospatial Information Working Group; Feature Data Dictionary Register, 2010).

2) Major road

IHO Definition: A hard surfaced (metalled) road; a main through route. (S-57 Edition 3.1, Appendix A – Chapter 2, Page 2.77, November 2000).

3) Minor road

IHO Definition: A secondary road for local traffic. (S-57 Edition 3.1, Appendix A – Chapter 2, Page 2.77, November 2000).

4) Track/path

IHO Definition: Track - a rough path or way formed by use. (Defence Geospatial Information Working Group; Feature Data Dictionary Register, 2010).

Path - a way or track laid down for walking or made by continual treading. (Defence Geospatial Information Working Group; Feature Data Dictionary Register, 2010).

5) Major street

IHO Definition: A main road, in an urban area, for through traffic. (S-57 Edition 3.1, Appendix A – Chapter 2, Page 2.77, November 2000).

6) Minor street

IHO Definition: A secondary road, in an urban area, for local traffic. (S-57 Edition 3.1, Appendix A – Chapter 2, Page 2.77, November 2000).

Remarks:

- No remarks.

27.55 Category of runway (CATRUN)

Category of runway: IHO Definition: **Definition required.**

1) Aeroplane runway

IHO Definition: A defined rectangular area, on a land aerodrome, prepared for the landing and take-off run of aircraft along its length. (IHO Dictionary – S-32).

2) Helicopter landing pad

IHO Definition: A site on which helicopters may land and take off. (IHO Dictionary – S-32).

Remarks:

- No remarks.

27.56 Category of schedule

Category of schedule: IHO Definition: The type of schedule, for instance opening, closure, etc.

1) Normal operation

IHO Definition: The service, office, is open, fully manned, and operating normally, or the area is accessible as usual.

2) **Closure**

IHO Definition: The service, office, or area is closed.

3) **Unmanned operation**

IHO Definition: The service is available but not manned.

Remarks:

- No remarks.

27.57 Category of sea area (CATSEA)

Category of sea area: IHO Definition: **Definition required.**

2) **Gat**

IHO Definition: A natural or artificial passage or channel through shoals or steep banks, or across a line of banks lying between two channels. (IHO Dictionary – S-32).

3) **Bank**

IHO Definition: An elevation over which the depth of water is relatively shallow, but normally sufficient for safe surface navigation. (IHO-IOC Publication B-6, Standardization of Undersea Feature Names, 2nd Edition).

4) **Deep**

IHO Definition: In oceanography, an obsolete term which was generally restricted to depths greater than 6,000 m. (IHO Dictionary – S-32).

5) **Bay**

IHO Definition: Wide indentation in the coastline generally smaller than a gulf and larger than a cove. (IHO Dictionary – S-32).

6) **Trench**

IHO Definition: A long narrow, characteristically very deep and asymmetrical depression of the sea floor, with relatively steep sides. (IHO-IOC Publication B-6, Standardization of Undersea Feature Names, 2nd Edition).

7) **Basin**

IHO Definition: A depression, characteristically in the deep sea floor, more or less equidimensional in plan and of variable extent. (adapted from IHO-IOC Publication B-6, Standardization of Undersea Feature Names, 2nd Edition).

8) **Mud flats**

IHO Definition: A level tract of land, as the bed of a dry lake or an area frequently uncovered at low tide. Usually in plural. (IHO Dictionary – S-32).

9) **Reef**

IHO Definition: Rock lying at or near the sea surface that may constitute a hazard to surface navigation. (IHO-IOC Publication B-6, Standardization of Undersea Feature Names, 2nd Edition).

10) **Ledge**

IHO Definition: A rocky formation continuous with and fringing the shore. (IHO Dictionary – S-32).

11) **Canyon**

IHO Definition: A relatively narrow, deep depression with steep sides, the bottom of which generally has a continuous slope, developed characteristically on some continental slopes. (IHO-IOC Publication B-6,

Standardization of Undersea Feature Names, 2nd Edition).

12) **Narrows**

IHO Definition: A navigable narrow part of a bay, strait, river, etc. (IHO Dictionary – S-32).

13) **Shoal**

IHO Definition: An offshore hazard to surface navigation that is composed of unconsolidated material. (Adapted from IHO-IOC Publication B-6, Standardization of Undersea Feature Names, 2nd Edition).

14) **Knoll**

IHO Definition: A relatively small isolated elevation of a rounded shape. (IHO-IOC Publication B-6, Standardization of Undersea Feature Names, 2nd Edition).

15) **Ridge**

IHO Definition: (a) A long, narrow elevation with steep sides. (IHO-IOC Publication B-6, Standardization of Undersea Feature Names, 2nd Edition).

(b) A long, narrow elevation often separating ocean basins. (IHO-IOC Publication B-6, Standardization of Undersea Feature Names, 2nd Edition).

(c) The linked major mid-oceanic mountain systems of global extent. Also called mid-oceanic ridge. (adapted from IHO-IOC Publication B-6, Standardization of Undersea Feature Names, 2nd Edition).

16) **Seamount**

IHO Definition: A large isolated elevation, greater than 1000m in relief above the sea floor, characteristically of conical form. (Adapted from IHO-IOC Publication B-6, Standardization of Undersea Feature Names, 2nd Edition).

17) **Pinnacle**

IHO Definition: Any high tower or spire-shaped pillar or rock or coral, alone or cresting a summit. It may extend above the surface of the water. It may or may not be a hazard to surface navigation. (IHO Dictionary – S-32).

18) **Abyssal plain**

IHO Definition: An extensive, flat, gently sloping or nearly level region at abyssal depths. (IHO-IOC Publication B-6, Standardization of Undersea Feature Names, 2nd Edition).

19) **Plateau**

IHO Definition: A flat or nearly flat area of considerable extent, dropping off abruptly on one or more sides. (IHO-IOC Publication B-6, Standardization of Undersea Feature Names, 2nd Edition).

20) **Spur**

IHO Definition: A subordinate elevation, ridge or rise projecting outward from a larger feature. (IHO-IOC Publication B-6, Standardization of Undersea Feature Names, 2nd Edition).

21) **Shelf**

IHO Definition: A zone adjacent to a continent (or around an island) and extending from the low water line to a depth at which there is usually a marked increase of slope towards oceanic depths. (IHO-IOC Publication B-6, Standardization of Undersea Feature Names, 2nd Edition).

22) **Trough**

IHO Definition: A long depression of the sea floor characteristically flat bottomed and steep sided and normally shallower than a trench. (IHO-IOC Publication B-6, Standardization of Undersea Feature Names, 2nd Edition).

23) **Saddle**

IHO Definition: A broad pass, resembling in shape a riding saddle, in a ridge or between contiguous seamounts. (IHO-IOC Publication B-6, Standardization of Undersea Feature Names, 2nd Edition).

24) Abyssal hills

IHO Definition: A tract, on occasion extensive, of low (100-500m) elevations on the deep sea floor. (Adapted from IHO-IOC Publication B-6, Standardization of Undersea Feature Names, 2nd Edition).

25) Apron

IHO Definition: A gently dipping featureless surface, underlain primarily by sediment, at the base of any steeper slope. (IHO-IOC Publication B-6, Standardization of Undersea Feature Names, 2nd Edition).

26) Archipelagic apron

IHO Definition: A gentle slope with a generally smooth surface on the sea floor, characteristically found around groups of islands or seamounts. (Adapted from IHO-IOC Publication B-6, Standardization of Undersea Feature Names, 2nd Edition).

27) Borderland

IHO Definition: A region adjacent to a continent, normally occupied by or bordering a shelf, that is highly irregular with depths well in excess of those typical of a shelf. (IHO-IOC Publication B-6, Standardization of Undersea Feature Names, 2nd Edition).

28) Continental margin

IHO Definition: The zone, generally consisting of shelf, slope and rise, separating the continent from the abyssal plain or deep sea floor. (Adapted from IHO-IOC Publication B-6, Standardization of Undersea Feature Names, 2nd Edition).

29) Continental rise

IHO Definition: A gentle slope rising from the oceanic depths towards the foot of a continental slope. (IHO-IOC Publication B-6, Standardization of Undersea Feature Names, 2nd Edition).

30) Escarpment

IHO Definition: An elongated and comparatively steep slope separating or gently sloping areas. Also called: scarp. (IHO-IOC Publication B-6, Standardization of Undersea Feature Names, 2nd Edition).

31) Fan

IHO Definition: A relatively smooth, fan-like, depositional feature normally sloping away from the outer termination of a canyon or canyon system. Also called: cone. (IHO-IOC Publication B-6, Standardization of Undersea Feature Names, 2nd Edition).

32) Fracture zone

IHO Definition: An extensive linear zone of irregular topography of the sea floor, characterized by steep-sided or asymmetrical ridges, troughs or escarpments. (IHO-IOC Publication B-6, Standardization of Undersea Feature Names, 2nd Edition).

33) Gap

IHO Definition: A narrow break in a ridge or a rise. (IHO-IOC Publication B-6, Standardization of Undersea Feature Names, 2nd Edition).

34) Guyot

IHO Definition: A seamount having a comparatively smooth flat top. Also called tablemount. (IHO Dictionary – S-32 and IHO-IOC Publication B-6, Standardization of Undersea Feature Names, 2nd Edition).

35) Hill

IHO Definition: A small isolated elevation (see also abyssal hills). (IHO-IOC Publication B-6, Standardization of Undersea Feature Names, 2nd Edition).

36) Hole

IHO Definition: A local depression, often steep sided, of the sea floor. (Adapted from IHO-IOC Publication B-6, Standardization of Undersea Feature Names, 2nd Edition).

37) Levee

IHO Definition: A depositional embankment bordering a canyon, valley or deep-sea channel. (IHO-IOC Publication B-6, Standardization of Undersea Feature Names, 2nd Edition).

38) Median valley

IHO Definition: The axial depression of the mid-oceanic ridge system. (IHO-IOC Publication B-6, Standardization of Undersea Feature Names, 2nd Edition).

39) Moat

IHO Definition: An annular depression that may not be continuous, located at the base of many seamounts, islands and other isolated elevations. (IHO-IOC Publication B-6, Standardization of Undersea Feature Names, 2nd Edition).

40) Mountains

IHO Definition: A large and complex grouping of ridges and seamounts. (IHO-IOC Publication B-6, Standardization of Undersea Feature Names, 2nd Edition).

41) Peak

IHO Definition: A prominent elevation either pointed or of a very limited extent across the summit. (IHO-IOC Publication B-6, Standardization of Undersea Feature Names, 2nd Edition).

42) Province

IHO Definition: A region identifiable by a group of similar physiographic features whose characteristics are markedly in contrast with surrounding areas. (IHO-IOC Publication B-6, Standardization of Undersea Feature Names, 2nd Edition).

43) Rise

IHO Definition: (a) A broad elevation that rises gently and generally smoothly from the sea floor.

(b) The linked major mid-oceanic mountain systems of global extent. Also called mid-oceanic ridge. (Adapted from IHO-IOC Publication B-6, Standardization of Undersea Feature Names, 2nd Edition).

44) Sea channel

IHO Definition: A continuously sloping, elongated narrow depression commonly found in fans or abyssal plains and customarily bordered by levees on one or both sides. (Adapted from IHO-IOC Publication B-6, Standardization of Undersea Feature Names, 2nd Edition).

45) Seamount chain

IHO Definition: Several seamounts in linear or arcuate alignment. Also called: seamounts. (Adapted from IHO-IOC Publication B-6, Standardization of Undersea Feature Names, 2nd Edition).

46) Shelf-edge

IHO Definition: A narrow zone at the seaward margin of a shelf along which is a marked increase of slope. Also called: shelf break. (Adapted from IHO-IOC Publication B-6, Standardization of Undersea Feature Names, 2nd Edition).

47) Sill

IHO Definition: A sea floor barrier of relatively shallow depth restricting water movement between basins. (Adapted from IHO-IOC Publication B-6, Standardization of Undersea Feature Names, 2nd Edition).

48) Slope

IHO Definition: The slope seaward from the shelf edge to the upper edge of a continental rise or the point where there is a general reduction in slope. (Adapted from IHO-IOC Publication B-6, Standardization of Undersea Feature Names, 2nd Edition).

49) Terrace

IHO Definition: A relatively flat horizontal or gently inclined surface, sometimes long and narrow, which is

bounded by a steeper ascending slope on one side and by a steeper descending slope on the opposite side. (IHO-IOC Publication B-6, Standardization of Undersea Feature Names, 2nd Edition).

50) **Valley**

IHO Definition: A relatively shallow, wide depression, the bottom of which usually has a continuous gradient. This term is generally not used for features that have canyon-like characteristics for a significant portion of their extent. Also called: submarine valley; sea valley. (IHO-IOC Publication B-6, Standardization of Undersea Feature Names, 2nd Edition).

51) **Canal**

IHO Definition: An artificial water course. (IHO Dictionary – S-32).

52) **Lake**

IHO Definition: A large body of water entirely surrounded by land. (IHO Dictionary – S-32).

53) **River**

IHO Definition: A relatively large natural stream of water. (IHO Dictionary – S-32).

54) **Reach**

IHO Definition: A straight section of a river, especially a navigable river between two bends or an arm of the sea extending into the land. (Adapted from IHO Dictionary – S-32).

55) **Intertidal cay**

IHO Definition: Definition required.

56) **Submarine volcano**

IHO Definition: Definition required.

Remarks:

- No remarks.

27.58 Category of shoreline construction (CATSLC)

Category of shoreline construction: IHO Definition: Definition required.

1) **Breakwater**

IHO Definition: A structure protecting a shore area, harbour, anchorage, or basin from waves. (IHO Dictionary – S-32).

2) **Groyne (groin)**

IHO Definition: A low artificial wall-like structure of durable material extending from the land to seaward for a particular purpose, such as to prevent coast erosion. (Adapted from IHO Dictionary – S-32 and IHO Chart Specifications, S-4).

3) **Mole**

IHO Definition: A form of breakwater alongside which vessels may lie on the sheltered side only; in some cases it may lie entirely within an artificial harbour, permitting vessels to lie along both sides. (S-57 Edition 3.1, Appendix A – Chapter 2, Page 2.84, November 2000).

4) **Pier (jetty)**

IHO Definition: A long, narrow structure extending into the water to afford a berthing place for vessels, to serve as a promenade, etc. (IHO Dictionary – S-32).

5) **Promenade pier**

IHO Definition: A pier built only for recreational purposes. (S-57 Edition 3.1, Appendix A – Chapter 2, Page 2.84, November 2000).

6) Wharf (quay)

IHO Definition: A structure serving as a berthing place for vessels. (IHO Dictionary – S-32).

7) Training wall

IHO Definition: A wall or bank, often submerged, built to direct or confine the flow of a river or tidal current, or to promote a scour action. (Adapted from IHO Dictionary – S-32 and IHO Chart Specifications, S-4).

8) Rip rap

IHO Definition: A layer of broken rock, cobbles, boulders, or fragments of sufficient size to resist the erosive forces of flowing water and wave action. (Adapted from Marine Chart Manual, US National Oceanic and Atmospheric Administration - NOAA, 1992).

9) Revetment

IHO Definition: Facing of stone or other material, either permanent or temporary, placed along the edge of a stream, river or canal to stabilize the bank and to protect it from the erosive action of the stream. (Adapted from IHO Dictionary – S-32).

10) Sea wall

IHO Definition: An embankment or wall for protection against waves or tidal action along a shore or water front. (IHO Dictionary – S-32).

11) Landing steps

IHO Definition: Steps at the shoreline as the connection between land and water on different levels. (Defence Geospatial Information Working Group; Feature Data Dictionary Register, 2010).

12) Ramp

IHO Definition: A sloping structure that can either be used, as a landing place, at variable water levels, for small vessels, landing ships, or a ferry boat, or for hauling a cradle carrying a vessel, which may include rails. (Adapted from IHO Dictionary – S-32).

13) Slipway

IHO Definition: The prepared and usually reinforced inclined surface on which keel- and bilge-blocks are laid for supporting a vessel under construction. (IHO Dictionary – S-32).

14) Fender

IHO Definition: A protective structure designed to cushion the impact of a vessel and prevent damage. (Defence Geospatial Information Working Group; Feature Data Dictionary Register, 2010).

15) Solid face wharf

IHO Definition: A wharf consisting of a solid wall of concrete, masonry, wood etc., such that the water cannot circulate freely under the wharf. The type of construction affects ship-handling; for example, a solid face wharf may give shelter from tidal streams, but under certain circumstances a cushion of water may build up between such a wharf and a ship attempting to berth at it, causing difficulties in ship handling. (Capt. A. Rae, pilot, Port of Halifax & Mr. R. Morash, wharf building engineer, Transport Canada).

16) Open face wharf

IHO Definition: A wharf supported on piles or other structures which allow free circulation of water under the wharf. (Capt. A. Rae, pilot, Port of Halifax & Mr. R. Morash, wharf building engineer, Transport Canada).

17) Log ramp

IHO Definition: An inclined plane used to dump logs into the water for transport, or to haul logs out of the water for processing. (Defence Geospatial Information Working Group; Feature Data Dictionary Register, 2010).

20) Swimming facility

IHO Definition: An artificial pool or swimming enclosure, especially one in the open air, which may be constructed of wire mesh or heavy netting supported by cables, buoys or piles, for swimming in. (Adapted

from the Macquarie Concise Dictionary).

Remarks:

- The attribute “category of shoreline construction” encodes the usage of a shoreline construction.

27.59 Category of signal station, traffic (CATSIT)

Category of signal station, traffic: IHO Definition: Definition required.

1) **Port control**

IHO Definition: A signal station for the control of vessels within a port. (S-57 Edition 3.1, Appendix A – Chapter 2, Page 2.86, November 2000).

2) **Port entry and departure**

IHO Definition: A signal station for the control of vessels entering or leaving a port. (S-57 Edition 3.1, Appendix A – Chapter 2, Page 2.86, November 2000).

3) **International port traffic**

IHO Definition: A signal station displaying International Port Traffic signals. (S-57 Edition 3.1, Appendix A – Chapter 2, Page 2.86, November 2000).

4) **Berthing**

IHO Definition: A signal station for the control of vessels when berthing. (S-57 Edition 3.1, Appendix A – Chapter 2, Page 2.86, November 2000).

5) **Dock**

IHO Definition: A signal station for the control of vessels entering or leaving a dock. (S-57 Edition 3.1, Appendix A – Chapter 2, Page 2.86, November 2000).

6) **Lock**

IHO Definition: A signal station for the control of vessels entering or leaving a lock. (S-57 Edition 3.1, Appendix A – Chapter 2, Page 2.86, November 2000).

7) **Flood barrage**

IHO Definition: A signal station for the control of vessels wishing to pass through a flood control barrage. (S-57 Edition 3.1, Appendix A – Chapter 2, Page 2.86, November 2000).

8) **Bridge passage**

IHO Definition: A signal station for the control of vessels wishing to pass under a bridge. (S-57 Edition 3.1, Appendix A – Chapter 2, Page 2.86, November 2000).

9) **Dredging**

IHO Definition: A signal station indicating when dredging is in progress. (S-57 Edition 3.1, Appendix A – Chapter 2, Page 2.86, November 2000).

10) **Traffic control light**

IHO Definition: Visual signal lights placed in a waterway to indicate to shipping the movements authorised at the time at which they are shown. (S-57 Edition 3.1, Appendix A – Chapter 2, Page 2.86, November 2000).

Remarks:

- No remarks.

27.60 Category of signal station, warning (CATSIW)

Category of signal station, warning: IHO Definition: Definition required.

1) Danger

IHO Definition: A signal or message warning of the presence of a danger to navigation. (S-57 Edition 3.1, Appendix A – Chapter 2, Page 2.87, November 2000).

2) Maritime obstruction

IHO Definition: A signal or message warning of the presence of a maritime obstruction. (S-57 Edition 3.1, Appendix A – Chapter 2, Page 2.87, November 2000).

3) Cable

IHO Definition: A signal or message warning of the presence of a cable. (S-57 Edition 3.1, Appendix A – Chapter 2, Page 2.87, November 2000).

4) Military practice

IHO Definition: A signal or message warning of activity in a military practice area. (S-57 Edition 3.1, Appendix A – Chapter 2, Page 2.87, November 2000).

5) Distress

IHO Definition: A station that may receive or transmit distress signals. (S-57 Edition 3.1, Appendix A – Chapter 2, Page 2.87, November 2000).

6) Weather

IHO Definition: A visual signal displayed to indicate a weather forecast. (IHO Dictionary – S-32).

7) Storm

IHO Definition: A signal or message conveying information about storm conditions. (S-57 Edition 3.1, Appendix A – Chapter 2, Page 2.87, November 2000).

8) Ice

IHO Definition: A signal or message conveying information about ice conditions. (S-57 Edition 3.1, Appendix A – Chapter 2, Page 2.87, November 2000).

9) Time

IHO Definition: An accurate signal marking a specified time or time interval. It is used primarily for determining errors of timepieces. Such signals are usually sent from an observatory by radio ~~or telegraph~~, but visual signals are used at some ports. (IHO Dictionary – S-32).

10) Tide

IHO Definition: A signal or message conveying information on tidal conditions in the area in question. (IHO Dictionary – S-32).

11) Tidal stream

IHO Definition: A signal or message conveying information on condition of tidal currents in the area in question. (IHO Dictionary – S-32).

12) Tide gauge

IHO Definition: A device for measuring the height of tide. A graduated staff in a sheltered area where visual observations can be made; or it may consist of an elaborate recording instrument making a continuous graphic record of tide height against time. Such an instrument is usually actuated by a float in a pipe communicating with the sea through a small hole which filters out shorter waves. (IHO Dictionary – S-32).

13) Tide scale

IHO Definition: A visual scale which directly shows the height of the water above chart datum or a local datum. (S-57 Edition 3.1, Appendix A – Chapter 2, Page 2.88, November 2000).

14) Diving

IHO Definition: A signal or message warning of diving activity. (S-57 Edition 3.1, Appendix A – Chapter 2, Page 2.88, November 2000).

15) Water level gauge

IHO Definition: A device for measuring and conveying information about the water level (non-tidal) in the area in question. (S-57 Edition 3.1, Appendix A – Chapter 2, Page 2.88, November 2000).

Remarks:

- No remarks.

27.61 Category of silo/tank (CATSIL)

Category of silo/tank: IHO Definition: **Definition required.**

1) Silo in general

IHO Definition: A large storage structure used for storing loose materials. (Defence Geospatial Information Working Group; Feature Data Dictionary Register, 2010).

2) Tank in general

IHO Definition: A fixed structure for storing liquids. (IHO Dictionary – S-32).

3) Grain elevator

IHO Definition: A storage building for grain. Usually a tall frame, metal or concrete structure with an especially compartmented interior. (The New Encyclopaedia Britannica Micropaedia, 15th Edition).

4) Water tower

IHO Definition: A tower supporting an elevated storage tank of water. (Defence Geospatial Information Working Group; Feature Data Dictionary Register, 2010).

Remarks:

- No remarks.

27.62 Category of slope (CATSLO)

Category of slope: IHO Definition: **Definition required.**

1) Cutting

IHO Definition: An excavation through high ground for a road, canal, etc. (S-57 Edition 3.1, Appendix A – Chapter 2, Page 2.90, November 2000).

2) Embankment

IHO Definition: A man-made raised long mound of earth or other material. (Defence Geospatial Information Working Group; Feature Data Dictionary Register, 2010).

3) Dune

IHO Definition: A mound, ridge or hill of drifted material on the sea coast or in a desert. (Adapted from IHO Dictionary – S-32).

4) Hill

IHO Definition: A small isolated elevation, smaller than a mountain. (IHO Dictionary – S-32).

5) Pingo

IHO Definition: A dome-shaped hill formed in a permafrost area when the hydrostatic pressure of freezing ground water causes the upheaval of a layer of frozen ground. (Encyclopaedia Britannica Micropaedia, 15th Edition).

6) Cliff

IHO Definition: Land rising abruptly for a considerable distance above the water or surrounding land. (IHO

Dictionary – S-32).

7) **Scree**

IHO Definition: A mass of detritus, forming a precipitous, strong slope upon a mountain-side. Also the material composing such a slope. (IHO Dictionary – S-32).

Remarks:

- No remarks.

27.63 Category of small craft facility (CATSCF)

Category of small craft facility: IHO Definition: **Definition required.**

1) **Visitor's berth**

IHO Definition: A berth set aside for the use of visiting vessels. (S-57 Edition 3.1, Appendix A – Chapter 2, Page 2.91, November 2000).

2) **Nautical club**

IHO Definition: A club for mariners generally associated with other small craft facilities. (S-57 Edition 3.1, Appendix A – Chapter 2, Page 2.91, November 2000).

3) **Boat hoist**

IHO Definition: A hoist for lifting boats out of the water (also known as a travel lift). (S-57 Edition 3.1, Appendix A – Chapter 2, Page 2.91, November 2000).

4) **Sailmaker**

IHO Definition: A place where sails are made or may be taken for repair. (S-57 Edition 3.1, Appendix A – Chapter 2, Page 2.91, November 2000).

5) **Boatyard**

IHO Definition: A place on shore where boats may be built, stored and repaired. (S-57 Edition 3.1, Appendix A – Chapter 2, Page 2.92, November 2000).

6) **Public inn**

IHO Definition: A public house providing food, drink and accommodation. (The Collins Reference English Dictionary, 1992).

7) **Restaurant**

IHO Definition: A commercial establishment serving food. (The Collins Reference Dictionary, 1992).

8) **Chandler**

IHO Definition: A dealer in ships' supplies. (The Collins Reference Dictionary, 1992).

9) **Provisions**

IHO Definition: A place where food and other such supplies are available. (S-57 Edition 3.1, Appendix A – Chapter 2, Page 2.92, November 2000).

10) **Doctor**

IHO Definition: A place where a doctor is available to provide medical attention. (S-57 Edition 3.1, Appendix A – Chapter 2, Page 2.92, November 2000).

11) **Pharmacy**

IHO Definition: A place where medical drugs are dispensed. (S-57 Edition 3.1, Appendix A – Chapter 2, Page 2.92, November 2000).

12) **Water tap**

IHO Definition: A place where fresh water is available. (S-57 Edition 3.1, Appendix A – Chapter 2, Page 2.92, November 2000).

13) Fuel station

IHO Definition: A place where fuel is available. (S-57 Edition 3.1, Appendix A – Chapter 2, Page 2.92, November 2000).

14) Electricity

IHO Definition: A place where a connection to an electrical supply is available. (S-57 Edition 3.1, Appendix A – Chapter 2, Page 2.92, November 2000).

15) Bottle gas

IHO Definition: A place where bottled gas is available. (S-57 Edition 3.1, Appendix A – Chapter 2, Page 2.92, November 2000).

16) Showers

IHO Definition: A place where showers are available. (S-57 Edition 3.1, Appendix A – Chapter 2, Page 2.92, November 2000).

17) Launderette

IHO Definition: A place where there are facilities for washing clothes. (S-57 Edition 3.1, Appendix A – Chapter 2, Page 2.92, November 2000).

18) Public toilets

IHO Definition: A place where toilets are available for public use. (S-57 Edition 3.1, Appendix A – Chapter 2, Page 2.92, November 2000).

19) Post box

IHO Definition: A place where mail may be posted. (S-57 Edition 3.1, Appendix A – Chapter 2, Page 2.92, November 2000).

20) Public telephone

IHO Definition: A place where a telephone is available for public use. (S-57 Edition 3.1, Appendix A – Chapter 2, Page 2.92, November 2000).

21) Refuse bin

IHO Definition: A place where refuse may be dumped. (S-57 Edition 3.1, Appendix A – Chapter 2, Page 2.92, November 2000).

22) Car park

IHO Definition: A place where cars may be parked. (S-57 Edition 3.1, Appendix A – Chapter 2, Page 2.92, November 2000).

23) Parking for boats and trailers

IHO Definition: A place on shore where boats and/or trailers may be parked. (S-57 Edition 3.1, Appendix A – Chapter 2, Page 2.92, November 2000).

24) Caravan site

IHO Definition: A place where caravans may be parked or where caravan accommodation is provided. (S-57 Edition 3.1, Appendix A – Chapter 2, Page 2.92, November 2000).

25) Camping site

IHO Definition: A place where visitors may pitch tents and camp. (S-57 Edition 3.1, Appendix A – Chapter 2, Page 2.92, November 2000).

26) Sewerage pump-out station

IHO Definition: A place where sewerage may be pumped off a vessel. (S-57 Edition 3.1, Appendix A – Chapter 2, Page 2.92, November 2000).

27) Emergency telephone

IHO Definition: A place where a telephone is available for emergency use only. (S-57 Edition 3.1,

Appendix A – Chapter 2, Page 2.92, November 2000).

28) Landing/launching place for boats

IHO Definition: A place where boats may be landed or launched. (S-57 Edition 3.1, Appendix A – Chapter 2, Page 2.92, November 2000).

29) Visitors mooring

IHO Definition: A mooring set aside for the use of visiting vessels. (S-57 Edition 3.1, Appendix A – Chapter 2, Page 2.92, November 2000).

30) Scrubbing berth

IHO Definition: A place where vessels may berth for the purpose of careening. (S-57 Edition 3.1, Appendix A – Chapter 2, Page 2.92, November 2000).

31) Picnic area

IHO Definition: A place where people may go to eat a picnic. (S-57 Edition 3.1, Appendix A – Chapter 2, Page 2.92, November 2000).

32) Mechanics workshop

IHO Definition: A place where mechanical repairs can be undertaken to engines or other vessel equipment. (S-57 Edition 3.1, Appendix A – Chapter 2, Page 2.92, November 2000).

33) Guard and/or security service

IHO Definition: A place where a vessel is patrolled by a security service or stored in a secure lockup. (S-57 Edition 3.1, Appendix A – Chapter 2, Page 2.92, November 2000).

Remarks:

- No remarks.

27.64 Category of special purpose mark (CATSPM)

Category of special purpose mark: IHO Definition: **Definition required.**

1) Firing danger mark

IHO Definition: A mark used to indicate a firing danger area, usually at sea. (S-57 Edition 3.1, Appendix A – Chapter 2, Page 2.94, November 2000).

2) Target mark

IHO Definition: Any feature toward which something is directed. The distinctive marking or instrumentation of a ground point to aid its identification on a photograph. (Adapted from IHO Dictionary – S-32).

3) Marker ship mark

IHO Definition: A mark marking the position of a ship which is used as a target during some military exercise. (Bundesamt für Seeschifffahrt und Hydrographie, Germany).

4) Degaussing range mark

IHO Definition: A mark used to indicate a degaussing range. (S-57 Edition 3.1, Appendix A – Chapter 2, Page 2.94, November 2000).

5) Barge mark

IHO Definition: A mark of relevance to barges. (S-57 Edition 3.1, Appendix A – Chapter 2, Page 2.94, November 2000).

6) Cable mark

IHO Definition: A mark used to indicate the position of submarine cables or the point at which they run on to the land. (S-57 Edition 3.1, Appendix A – Chapter 2, Page 2.94, November 2000).

7) Spoil ground mark

IHO Definition: A mark used to indicate the limit of a spoil ground. (Adapted from IHO Dictionary – S-32).

8) **Outfall mark**

IHO Definition: A mark used to indicate the position of an outfall or the point at which it leaves the land. (S-57 Edition 3.1, Appendix A – Chapter 2, Page 2.94, November 2000).

9) **ODAS**

IHO Definition: Ocean Data Acquisition System. (IHO Dictionary – S-32).

10) **Recording mark**

IHO Definition: A mark used to record data for scientific purposes. (S-57 Edition 3.1, Appendix A – Chapter 2, Page 2.94, November 2000).

11) **Seaplane anchorage mark**

IHO Definition: A mark used to indicate a seaplane anchorage. (S-57 Edition 3.1, Appendix A – Chapter 2, Page 2.94, November 2000).

12) **Recreation zone mark**

IHO Definition: A mark used to indicate a recreation zone. (S-57 Edition 3.1, Appendix A – Chapter 2, Page 2.94, November 2000).

14) **Mooring mark**

IHO Definition: A mark indicating a mooring or moorings. (S-57 Edition 3.1, Appendix A – Chapter 2, Page 2.94, November 2000).

15) **LANBY (Large Automatic navigational Buoy)**

IHO Definition: A large buoy designed to take the place of a lightship where construction of an offshore light station is not feasible. (IHO Dictionary – S-32).

16) **Leading mark**

IHO Definition: Aids to navigation or other indicators so located as to indicate the path to be followed. Leading marks identify a leading line when they are in transit. (IHO Dictionary – S-32).

17) **Measured distance mark**

IHO Definition: A mark forming part of a transit indicating one end of a measured distance. (S-57 Edition 3.1, Appendix A – Chapter 2, Page 2.94, November 2000).

18) **Notice mark**

IHO Definition: A notice board or sign indicating information to the mariner. (S-57 Edition 3.1, Appendix A – Chapter 2, Page 2.94, November 2000).

19) **TSS Mark**

IHO Definition: A mark indicating a Traffic Separation Scheme. (S-57 Edition 3.1, Appendix A – Chapter 2, Page 2.94, November 2000).

20) **Anchoring prohibited mark**

IHO Definition: A mark indicating an anchoring prohibited area. (S-57 Edition 3.1, Appendix A – Chapter 2, Page 2.95, November 2000).

21) **Berthing prohibited mark**

IHO Definition: A mark indicating that berthing is prohibited. (S-57 Edition 3.1, Appendix A – Chapter 2, Page 2.95, November 2000).

22) **Overtaking prohibited mark**

IHO Definition: A mark indicating that overtaking is prohibited. (S-57 Edition 3.1, Appendix A – Chapter 2, Page 2.95, November 2000).

23) **Two-way traffic prohibited mark**

IHO Definition: A mark indicating a one-way route. (S-57 Edition 3.1, Appendix A – Chapter 2, Page 2.95,

November 2000).

24) **“Reduced wake” mark**

IHO Definition: A mark indicating that vessels must not generate excessive wake. (S-57 Edition 3.1, Appendix A – Chapter 2, Page 2.95, November 2000).

25) **Speed limit mark**

IHO Definition: A mark indicating that a speed limit applies. (S-57 Edition 3.1, Appendix A – Chapter 2, Page 2.95, November 2000).

26) **Stop mark**

IHO Definition: A mark indicating the place where the bow of a ship must stop when traffic lights show red. (S-57 Edition 3.1, Appendix A – Chapter 2, Page 2.95, November 2000).

27) **General warning mark**

IHO Definition: A mark indicating that special caution must be exercised in the vicinity of the mark. (S-57 Edition 3.1, Appendix A – Chapter 2, Page 2.95, November 2000).

28) **“Sound ship’s siren” mark**

IHO Definition: A mark indicating that a ship should sound its siren or horn. (S-57 Edition 3.1, Appendix A – Chapter 2, Page 2.95, November 2000).

29) **Restricted vertical clearance mark**

IHO Definition: A mark indicating the minimum vertical space available for passage. (S-57 Edition 3.1, Appendix A – Chapter 2, Page 2.95, November 2000).

30) **Maximum vessel’s draught mark**

IHO Definition: A mark indicating the maximum draught of vessel permitted. (S-57 Edition 3.1, Appendix A – Chapter 2, Page 2.95, November 2000).

31) **Restricted horizontal clearance mark**

IHO Definition: A mark indicating the minimum horizontal space available for passage. (S-57 Edition 3.1, Appendix A – Chapter 2, Page 2.95, November 2000).

32) **Strong current warning mark**

IHO Definition: A mark warning of strong currents. (S-57 Edition 3.1, Appendix A – Chapter 2, Page 2.95, November 2000).

33) **Berthing permitted mark**

IHO Definition: A mark indicating that berthing is allowed. (S-57 Edition 3.1, Appendix A – Chapter 2, Page 2.95, November 2000).

34) **Overhead power cable mark**

IHO Definition: A mark indicating an overhead power cable. (S-57 Edition 3.1, Appendix A – Chapter 2, Page 2.95, November 2000).

35) **“Channel edge gradient” mark**

IHO Definition: A mark indicating the gradient of the slope of a dredge channel edge. (S-57 Edition 3.1, Appendix A – Chapter 2, Page 2.95, November 2000).

36) **Telephone mark**

IHO Definition: A mark indicating the presence of a telephone. (S-57 Edition 3.1, Appendix A – Chapter 2, Page 2.95, November 2000).

37) **Ferry crossing mark**

IHO Definition: A mark indicating that a ferry route crosses the ship route; often used with a “sound ship’s siren” mark. (S-57 Edition 3.1, Appendix A – Chapter 2, Page 2.95, November 2000).

39) **Pipeline mark**

IHO Definition: A mark used to indicate the position of submarine pipelines or the point at which they run on to the land. (S-57 Edition 3.1, Appendix A – Chapter 2, Page 2.95, November 2000).

40) Anchorage mark

IHO Definition: A mark indicating an anchorage area. (S-57 Edition 3.1, Appendix A – Chapter 2, Page 2.95, November 2000).

41) Clearing mark

IHO Definition: A mark used to indicate a clearing line. (S-57 Edition 3.1, Appendix A – Chapter 2, Page 2.95, November 2000).

42) Control mark

IHO Definition: A mark indicating the location at which a restriction or requirement exists. (S-57 Edition 3.1, Appendix A – Chapter 2, Page 2.96, November 2000).

43) Diving mark

IHO Definition: A mark indicating that diving may take place in the vicinity. (S-57 Edition 3.1, Appendix A – Chapter 2, Page 2.96, November 2000).

44) Refuge beacon

IHO Definition: A mark providing or indicating a place of safety. (S-57 Edition 3.1, Appendix A – Chapter 2, Page 2.95, November 2000).

45) Foul ground mark

IHO Definition: A mark indicating a foul ground. (S-57 Edition 3.1, Appendix A – Chapter 2, Page 2.96, November 2000).

46) Yachting mark

IHO Definition: A mark installed for use by yachtsmen. (S-57 Edition 3.1, Appendix A – Chapter 2, Page 2.96, November 2000).

47) Heliport mark

IHO Definition: A mark indicating an area where helicopters may land. (S-57 Edition 3.1, Appendix A – Chapter 2, Page 2.96, November 2000).

48) GNSS mark

IHO Definition: A mark indicating a location at which a GNSS position has been accurately determined.

49) Seaplane landing mark

IHO Definition: A mark indicating an area where seaplanes land. (S-57 Edition 3.1, Appendix A – Chapter 2, Page 2.96, November 2000).

50) Entry prohibited mark

IHO Definition: A mark indicating that entry is prohibited. (S-57 Edition 3.1, Appendix A – Chapter 2, Page 2.96, November 2000).

51) Work in progress mark

IHO Definition: A mark indicating that work (generally construction) is in progress. (S-57 Edition 3.1, Appendix A – Chapter 2, Page 2.96, November 2000).

52) Mark with unknown purpose

IHO Definition: A mark whose detailed characteristics are unknown. (S-57 Edition 3.1, Appendix A – Chapter 2, Page 2.96, November 2000).

53) Wellhead mark

IHO Definition: A mark indicating a borehole that produces or is capable of producing oil or natural gas. (Adapted from IHO Dictionary – S-32).

54) Channel separation mark

IHO Definition: A mark indicating the point at which a channel divides separately into two channels. (S-57 Edition 3.1, Appendix A – Chapter 2, Page 2.96, November 2000).

55) **Marine farm mark**

IHO Definition: A mark indicating the existence of a fish, mussel, oyster or pearl farm/ culture. (S-57 Edition 3.1, Appendix A – Chapter 2, Page 2.96, November 2000).

56) **Artificial reef mark**

IHO Definition: A mark indicating the existence or the extent of an artificial reef. (S-57 Edition 3.1, Appendix A – Chapter 2, Page 2.96, November 2000).

57) **Ice mark**

IHO Definition: A mark, used year round, that may be submerged when ice passes through the area.

58) **Nature reserve mark**

IHO Definition: A mark used to define the boundary of a nature reserve.

59) **Fish aggregating device (FAD)**

IHO Definition: Definition required.

60) **Wreck mark**

IHO Definition: A mark used to indicate the existence of a wreck.

61) **Customs mark**

IHO Definition: Definition required.

62) **Causeway mark**

IHO Definition: A mark used to indicate the existence of a causeway.

63) **Wave recorder**

IHO Definition: Definition required.

Remarks:

- A mark may be a beacon, a buoy, a signpost or may take another form.

27.65 Category of tidal stream (CAT_TS)

Category of tidal stream: IHO Definition: Definition required.

1) **Flood stream**

IHO Definition: The horizontal movement of water associated with the rising tide. Flood streams generally set towards the shore, or in the direction of the tide progression. Also called flood, flood current or ingoing stream. (Adapted from IHO Dictionary – S-32).

2) **Ebb stream**

IHO Definition: The horizontal movement of water associated with falling tide. Ebb streams generally set seaward, or in the opposite direction to the tide progression. Also called ebb, ebb current or outgoing stream. (IHO Dictionary – S-32).

3) **Other tidal flow**

IHO Definition: Any other horizontal movement of water associated with tides, for example rotary flow. (S-57 Edition 3.1, Appendix A – Chapter 2, Page 2.97, November 2000).

Remarks:

- No remarks.

27.66 Category of Traffic Separation Scheme (CATTSS)

Category of traffic separation scheme: IHO Definition: Definition required.

1) IMO - adopted

IHO Definition: A defined Traffic Separation Scheme that has been adopted as an IMO routing measure. (S-57 Edition 3.1, Appendix A – Chapter 2, Page 2.99, November 2000).

2) Not IMO - adopted

IHO Definition: A defined Traffic Separation Scheme that has not been adopted as an IMO routing measure. S-57 Edition 3.1, Appendix A – Chapter 2, Page 2.99, November 2000).

Remarks:

- No remarks.

27.67 Category of vegetation (CATVEG)

Category of land vegetation: IHO Definition: Definition required.

3) Bush

IHO Definition: A shrub or clump of shrubs with stems of moderate length. (The Concise Oxford Dictionary).

4) Deciduous wood

IHO Definition: A wood with trees that shed their leaves annually. (Bundesamt für Seeschifffahrt und Hydrographie, Germany).

5) Coniferous wood

IHO Definition: A wood with evergreen trees of a group usually bearing cones, including yews, cedars and redwoods. (Bundesamt für Seeschifffahrt und Hydrographie, Germany).

6) Wood in general (inc mixed wood)

IHO Definition: Growing trees densely occupying a tract of land. (The Concise Oxford Dictionary).

7) Mangroves

IHO Definition: One of several genera of tropical trees or shrubs which produce many prop roots and grow along low lying coasts into shallow water. (IHO Dictionary – S-32).

13) Tree in general

IHO Definition: An individual woody perennial plant, typically having a single stem or trunk growing to a considerable height and bearing lateral branches at some distance from the ground. (Defence Geospatial Information Working Group; Feature Data Dictionary Register, 2010).

14) Evergreen tree

IHO Definition: Having green foliage all the year round. (Defence Geospatial Information Working Group; Feature Data Dictionary Register, 2010).

15) Coniferous tree

IHO Definition: A cone-bearing, needle-leaved or scale-leaved evergreen tree. (Adapted from The New Encyclopaedia Britannica, 15th Edition 1991).

16) Palm tree

IHO Definition: A tropical or sub-tropical tree, shrub or vine having a tall, unbranched, columnar trunk. The trunk is crowned by a tuft or large, pleated fan or feather shaped leaves with stout sheathing and often prickly petioles (stalks), the persistent bases of which frequently clothe the trunk. (Adapted from The New Encyclopedia Britannica, 15th Edition 1991).

17) Nipa palm tree

IHO Definition: (Also called Nypa palm). A rare palm tree with regular branching involving equal or sub-equal division of the apex that results in forking. (Adapted from The New Encyclopedia Britannica, 15th Edition 1991).

18) Casuarina tree

IHO Definition: (Also called beefwood, Australian pine, ironwood, she-oak, swamp oak, whistling pine). A tree characterized by slender, green, often drooping branches that are deeply grooved and that bear, at intervals, whorls of fine leaves. (Adapted from The New Encyclopedia Britannica, 15th Edition 1991).

19) Eucalypt tree

IHO Definition: An instance of a large genus of mostly very large trees (90 metres). (Adapted from The New Encyclopaedia Britannica, 15th Edition 1991).

20) Deciduous tree

IHO Definition: Sheds its leaves each year at the end of the period of growth. (Defence Geospatial Information Working Group; Feature Data Dictionary Register, 2010).

21) Mangrove tree

IHO Definition: One of several genera of tropical trees or shrubs which produce many prop roots and grow along low lying coasts in to shallow waters. (IHO Dictionary – S-32).

22) Filao tree

IHO Definition: Casuarina equisetifolia, the most widespread and well-known member of the family Casuarinaceae. (Defence Geospatial Information Working Group; Feature Data Dictionary Register, 2010).

Remarks:

- No remarks.

27.68 Category of water turbulence (CATWAT)

Category of water turbulence: IHO Definition: Definition required.

1) Breaker

IHO Definition: A wave breaking on the shore, over a reef, etc. Breakers may be roughly classified into three kinds, although the categories may overlap: spilling breakers break gradually over a considerable distance; plunging breakers tend to curl over and break with a crash; and surging breakers peak up, but then instead of spilling or plunging they surge up on the beach face. The French word “brisant” is also used for the obstacle causing the breaking of the wave. (IHO Dictionary – S-32).

2) Eddies

IHO Definition: Circular movements of water usually formed where currents pass obstructions, between two adjacent currents flowing counter to each other, or along the edge of a permanent current. (IHO Dictionary – S-32).

3) Overfalls

IHO Definition: Short, breaking waves occurring when a strong current passes over a shoal or other submarine obstruction or meets a contrary current or wind. (IHO Dictionary – S-32).

4) Tide rips

IHO Definition: Small waves formed on the surface of water by the meeting of opposing tidal currents or by a tidal current crossing an irregular bottom. (IHO Dictionary – S-32).

5) Bombora

IHO Definition: A wave that forms over a submerged offshore reef or rock, sometimes (in very calm weather or at high tide) nearly swelling but in other conditions breaking heavily and producing a dangerous

stretch of broken water; the reef or rock itself. Also called bumbora or bomborah. (Australian National Dictionary).

Remarks:

- No remarks.

27.69 Category of weed/kelp (CATWED)

Category of weed/kelp: IHO Definition: Definition required.

1) **Kelp**

IHO Definition: A giant plant sometimes 60 metres long with no roots, it is anchored by hold-fasts or tendrils up to 10 metres long, that cling to rock. Gas filled bubbles on fronds act as floats keeping the kelp just below the surface. (Earth Sciences References; Mary McNeil).

2) **Seaweed**

IHO Definition: General name for marine plants of the algae class which grow in long narrow ribbons. Also called seagrass. (International Maritime Dictionary, 2nd Edition).

3) **Seagrass**

IHO Definition: Any grass-like marine alga. Eelgrass is one of the best known seagrasses. (IHO Dictionary – S-32).

4) **Sargasso**

IHO Definition: A certain type of seaweed, or more generally, a large floating mass of this seaweed. (IHO Dictionary – S-32).

Remarks:

- No remarks.

27.70 Category of wreck (CATWRK)

Category of wreck: IHO Definition: Definition required.

1) **Non-dangerous wreck**

IHO Definition: A wreck which is not considered to be dangerous to surface navigation. (S-57 Edition 3.1, Appendix A – Chapter 2, Page 2.105, November 2000).

2) **Dangerous wreck**

IHO Definition: A wreck submerged at such a depth as to be considered dangerous to surface navigation. (IHO Dictionary – S-32).

3) **Distributed remains of wreck**

IHO Definition: (Foul ground). An area over which it is safe to navigate but which should be avoided for anchoring, taking the ground or ground fishing. (S-57 Edition 3.1, Appendix A – Chapter 2, Page 2.105, November 2000).

4) **Wreck showing mast/masts**

IHO Definition: Wreck of which only the mast(s) is visible at the sounding datum indicated. (S-57 Edition 3.1, Appendix A – Chapter 2, Page 2.105, November 2000).

5) **Wreck showing any portion of hull or superstructure**

IHO Definition: Wreck of which any portion of the hull or superstructure is visible at the sounding datum indicated. (S-57 Edition 3.1, Appendix A – Chapter 2, Page 2.105, November 2000).

27.71 Colour (COLOUR)

Colour: IHO Definition: Definition required.

- 1) **White**
- 2) **Black**
- 3) **Red**
- 4) **Green**
- 5) **Blue**
- 6) **Yellow**
- 7) **Grey**
- 8) **Brown**
- 9) **Amber**
- 10) **Violet**
- 11) **Orange**
- 12) **Magenta**
- 13) **Pink**

Remarks:

- No remarks.

27.72 Colour pattern (COLPAT)

Colour pattern: IHO Definition: Definition required.

1) **Horizontal stripes**

IHO Definition: Straight bands or stripes of differing colours oriented horizontally. (Adapted from S-57 Edition 3.1, Appendix A – Chapter 2, Page 2.113, November 2000).

2) **Vertical stripes**

IHO Definition: Straight bands or stripes of differing colours oriented vertically. (Adapted from S-57 Edition 3.1, Appendix A – Chapter 2, Page 2.113, November 2000).

3) **Diagonal stripes**

IHO Definition: Straight bands or stripes of differing colours oriented diagonally (that is, not horizontally or vertically). (Adapted from S-57 Edition 3.1, Appendix A – Chapter 2, Page 2.113, November 2000).

4) **Squared**

IHO Definition: Often referred to as checker plate, where alternate colours are used to create squares similar to a chess or draught board. The pattern may be straight or diagonal. (S-57 Edition 3.1, Appendix A – Chapter 2, Page 2.113, November 2000).

5) **Stripes (direction unknown)**

IHO Definition: Straight bands or stripes of differing colours oriented in an unknown direction. (Adapted from S-57 Edition 3.1, Appendix A – Chapter 2, Page 2.113, November 2000).

6) **Border stripe**

IHO Definition: A band or stripe of colour which is displayed around the outer edge of the feature, which may also form a border to an inner pattern or plain colour. (S-57 Edition 3.1, Appendix A – Chapter 2, Page 2.113, November 2000).

Remarks:

- No remarks.

27.73 Communication channel (COMCHA)

Communication channel: IHO Definition: A channel number assigned to a specific radio frequency, frequencies or frequency band. (S-57 Edition 3.1, Appendix A – Chapter 2, Page 2.114, November 2000).

Expected input: Enter specific Communication Channel.

Indication: Each Channel should be indicated in square brackets by 4 digits and up to 4 characters (A-Z).

Format: [XXXX]

Example: [VHF0007] for VHF-Channel 7

[NBDP5555] for Narrow Band Direct Printing Channel 5555

Remarks:

- The attribute “communication channel” encodes the various Channels used for all methods of radio communication.

27.74 Condition (CONDTN)

Condition: IHO Definition: Definition required.

1) Under construction

IHO Definition: Being built but not yet capable of function. (Defence Geospatial Information Working Group; Feature Data Dictionary Register, 2010).

2) Ruined

IHO Definition: A structure in a decayed or deteriorated condition resulting from neglect or disuse, or a damaged structure in need of repair. (IHO Dictionary – S-32).

3) Under reclamation

IHO Definition: An area of the sea, a lake or the navigable part of a river that is being reclaimed as land, usually by the dumping of earth and other material. (Adapted from S-57 Edition 3.1, Appendix A – Chapter 2, Page 2.118, November 2000).

4) Wingless

IHO Definition: A windmill or wind turbine from which the vanes or turbine blades are missing. (Adapted from S-57 Edition 3.1, Appendix A – Chapter 2, Page 2.118, November 2000).

5) Planned construction

IHO Definition: Detailed planning has been completed but construction has not been initiated. (Defence Geospatial Information Working Group; Feature Data Dictionary Register, 2010).

Remarks:

- The attribute “condition” encodes the various conditions of buildings and other constructions. The default “condition” should be considered to be completed, undamaged and working normally. This attribute should, therefore, only be used to indicate features whose condition is anything other than “normal”.

27.75 Contact instructions

Contact instructions: IHO Definition: Instructions provided on how to contact a particular person, organisation or service.

Remarks:

- Where required, **contact instructions** should also provide information on the access times for a particular

person, organisation or service.

27.76 Date disused

Date disused: IHO Definition: The date that an entity ceases to be used. (Adapted from S-4).

Indication: The **date disused** should be encoded using 4 digits for the calendar year (YYYY), 2 digits for the month (MM) (for example April = 04) and 2 digits for the day (DD). When no specific month and/or day is required/known, indication of the month and/or day is omitted, and replaced with dashes (-). When no specific year is required (that is, the event or date range ends at the same time each year) the following two cases may be considered:

- same day each year: ----MMDD
- same month each year: ----MM--

This conforms to ISO 8601: 2004.

Format:

YYYYMMDD	(full date, mandatory)
YYYYMM--	(no specific day required – mandatory)
YYYY----	(no specific month required – mandatory)
----MMDD	(same day each year, mandatory)
----MM--	(same month each year, mandatory)

Example: **20160908** for 08 September 2016 as the date an entity ceased to be used.

Remarks:

- No remarks.

27.77 Date end (DATEND)

Date end: IHO Definition: **Definition required.**

Indication: The **date end** should be encoded using 4 digits for the calendar year (YYYY), 2 digits for the month (MM) (for example April = 04) and 2 digits for the day (DD). When no specific month and/or day is required/known, indication of the month and/or day is omitted, and replaced with dashes (-). When no specific year is required (that is, the event or date range ends at the same time each year) the following two cases may be considered:

- same day each year: ----MMDD
- same month each year: ----MM--

This conforms to ISO 8601: 2004.

Format:

YYYYMMDD	(full date, mandatory)
YYYYMM--	(no specific day required – mandatory)
YYYY----	(no specific month required – mandatory)
----MMDD	(same day each year, mandatory)
----MM--	(same month each year, mandatory)

Example: **20101203** for 03 December 2010 as ending date.

Remarks:

- The attribute **date end** indicates the latest date of an event or the end of a date range. This attribute is used to indicate the end of a fixed date range, the end of a periodic date range, or the removal or cancellation of a feature at a specific date in the future.

27.78 Date fixed

Date fixed: IHO Definition: The date of an event.

Indication: The **date fixed** should be encoded using 4 digits for the calendar year (YYYY), 2 digits for the

month (MM) (for example April = 04) and 2 digits for the day (DD). When no specific month and/or day is required/known, indication of the month and/or day is omitted, and replaced with dashes (-). When no specific year is required (that is, the event or date range ends at the same time each year) the following two cases may be considered:

- same day each year: ----MMDD
- same month each year: ----MM--

This conforms to ISO 8601: 2004.

Format: ----MMDD (same day each year, **mandatory**)
 ----MM-- (same month each year, **mandatory**)

Example: ----**0908** for 08 September each year.
 ----**02--** for February of each year.

Remarks:

- No remarks.

27.79 Date start (DATSTA)

Date start: IHO Definition: **Definition required.**

Indication: The **date start** should be encoded using 4 digits for the calendar year (YYYY), 2 digits for the month (MM) (for example April = 04) and 2 digits for the day (DD). When no specific month and/or day is required/known, indication of the month and/or day is omitted, and replaced with dashes (-). When no specific year is required (that is, the event or date range ends at the same time each year) the following two cases may be considered:

- same day each year: ----MMDD
- same month each year: ----MM--

This conforms to ISO 8601: 2004.

Format: YYYYMMDD (full date, **mandatory**)
 YYYYMM-- (no specific day required – **mandatory**)
 YYYY---- (no specific month required – **mandatory**)
 ----MMDD (same day each year, **mandatory**)
 ----MM-- (same month each year, **mandatory**)

Example: **20101129** for 29 November 2010 as starting date.

Remarks:

- The attribute **date start** indicates the earliest date of an event or the start of a date range. This attribute is used to indicate the start of a fixed date range, the start of a periodic date range, or the deployment or implementation of a feature at a specific date in the future.

27.80 Date variable

Date variable: IHO Definition: A day which is not fixed in the Gregorian calendar.

Indication: The string encodes a recurring day each year that is not fixed in the Gregorian calendar.

Example: **Fourth Thursday in November**
Easter Sunday

Remarks:

- No remarks.

27.81 Day of week

Day of week: IHO Definition: Definition required.

Indication: The attribute defines a day of the week.

Format: **Codelist Type** closed enumeration see clause X.X

Expected input:

- 1) **Monday**
- 2) **Tuesday**
- 3) **Wednesday**
- 4) **Thursday**
- 5) **Friday**
- 6) **Saturday**
- 7) **Sunday**

Remarks:

- No remarks.

27.82 Day of week is range

Day of week is range: IHO Definition: A statement expressing if the days of the week identified define a range or not.

Indication: Boolean. A True value is an indication that the identified days of the week define a range between and inclusive of those days.

Remarks:

- No remarks.

27.83 Depth range maximum value (DRVAL2)

Depth range maximum value: IHO Definition: Depth range is the depth from a specified sounding datum as a depth interval bounded by the minimum (shoalest) and maximum (deepest) depth values. (Defence Geospatial Information Working Group; Feature Data Dictionary Register, 2010).

depth range maximum value defines the maximum (deepest) value of a depth range. (S-57 Edition 3.1, Appendix A – Chapter 2, Page 2.125, November 2000).

Unit: Defined in the AXUM subfield of the CSAX record: metre (m)

Resolution: 0.1m

Format: sxxxxx.x
s: sign, negative values only

Example: **100** for a maximum depth of 100 metres

Remarks:

- Where the area dries, the value is negative or zero (0).

27.84 Depth range minimum value (DRVAL1)

Depth range minimum value: IHO Definition: Depth range is the depth from a specified sounding datum as a depth interval bounded by the minimum (shoalest) and maximum (deepest) depth values. (Defence

Geospatial Information Working Group; Feature Data Dictionary Register, 2010).

depth range minimum value defines the minimum (shoalest) value of a depth range. (S-57 Edition 3.1, Appendix A – Chapter 2, Page 2.124, November 2000).

Unit: Defined in the AXUM subfield of the CSAX record: metre (m)

Resolution: 0.1m

Format: sxxxxx.x

s: sign, negative values only

Example: **50** for a minimum depth of 50 metres

Remarks:

- Where the area dries, the value is negative.

27.85 Directional

Directional: IHO Definition: A directional light is a light illuminating a sector of very narrow angle and intended to mark a direction to follow. (IHO Dictionary – S-32).

Indication: Boolean. A True value is an indication that the encoded light sector has a directional function.

Remarks:

- No remarks.

27.86 Display name

Display name: IHO Definition: A statement expressing if a feature name is to be displayed in certain system display settings or not.

Indication: Boolean. A True value is an indication that the name is intended to be displayed.

Remarks:

- Where it is allowable to encode multiple instances of feature name for a single feature instance, only one feature name instance can indicate that the name is to be displayed (**display name** set to *True*).

27.87 Distance unit of measurement

Distance unit of measurement: IHO Definition: **Definition required.**

- 1) **Metres**
- 2) **Yards**
- 3) **Kilometres**
- 4) **Statute miles**
- 5) **Nautical miles**

Remarks:

- No remarks.

27.88 Dredged date

Dredged date: IHO Definition: **Definition required.**

Indication: The **dredged date** should be encoded using 4 digits for the calendar year (YYYY), 2 digits for the month (MM) (for example April = 04) and 2 digits for the day (DD). When no specific month and/or day is required/known, indication of the month and/or day is omitted, and replaced with dashes (-).

This conforms to ISO 8601:2004.

Format: YYYYMMDD (full date, **mandatory**)
 YYYYMM-- (no specific day required – **mandatory**)
 YYYY---- (no specific month required – **mandatory**)

Example: **20101203** for 03 December 2010 as the dredged date.

Remarks:

- The attribute **dredged date** indicates the latest date of dredging (which may be the latest known date if the dredged area is not maintained), or the date of the latest control survey confirming the depth in a maintained dredged area.

27.89 Elevation (ELEVAT)

Elevation: IHO Definition: The altitude of the ground level of an feature, measured from a specified vertical datum. (S-57 Edition 3.1, Appendix A – Chapter 2, Page 2.127, November 2000).

Unit: Defined as an attribute in the ENC dataset metadata: metre (m).

Resolution: 0.1m

Format: xxxx.x

Minimum value: 0

Example: **47** for an elevation of 47 metres

Remarks:

- No remarks.

27.90 Estimated range of transmission (ESTRNG)

Estimated range of transmission: IHO Definition: The estimated range of a non-optical electromagnetic transmission. (S-57 Edition 3.1, Appendix A – Chapter 2, Page 2.128, November 2000).

Unit: Nautical mile (M)

Resolution: 0.1M

Format: xxx.x

Example: **45** for a maximum range of 45 nautical miles

Remarks:

- The estimated range (distance) assumes “in vacuo” transmission and a standard antenna height of 5 metres. Thus it gives a hint to the mariner whether they are likely to receive transmission at a certain distance from a feature carrying this attribute.

27.91 Exhibition condition of light (EXCLIT)

Exhibition condition of light: IHO Definition: **Definition required.**

1) Light shown without change of character

IHO Definition: A light shown throughout the 24 hours without change of character. (S-57 Edition 3.1, Appendix A – Chapter 2, Page 2.129, November 2000).

2) Daytime light

IHO Definition: A light which is only exhibited by day. (S-57 Edition 3.1, Appendix A – Chapter 2, Page 2.129, November 2000).

3) Fog light

IHO Definition: A light which is exhibited in fog or conditions of reduced visibility. (S-57 Edition 3.1, Appendix A – Chapter 2, Page 2.129, November 2000).

4) **Night light**

IHO Definition: A light which is only exhibited at night. (S-57 Edition 3.1, Appendix A – Chapter 2, Page 2.129, November 2000).

Remarks:

- No remarks.

27.92 Exposition of sounding (EXPSOU)

Exposition of sounding: IHO Definition: **Definition required.**

1) **Within the range of depth of the surrounding depth area**

IHO Definition: The depth corresponds to the depth range of the surrounding depth area; that is, the depth is not shoaler than the minimum depth of the surrounding depth area or deeper than the maximum depth of the surrounding depth area. (S-57 Edition 3.1, Appendix A – Chapter 2, Page 2.130, November 2000).

2) **Shoaler than the range of depth of the surrounding depth area**

IHO Definition: The depth is shoaler than the minimum depth of the surrounding depth area. (S-57 Edition 3.1, Appendix A – Chapter 2, Page 2.130, November 2000).

3) **Deeper than the range of depth of the surrounding depth area**

IHO Definition: The depth is deeper than the maximum depth of the surrounding depth area. (S-57 Edition 3.1, Appendix A – Chapter 2, Page 2.130, November 2000).

Remarks:

- This attribute indicates features with a “value of sounding” not within the range of depth of the surrounding depth area. These features could be a potential danger for navigation.

27.93 File locator

File locator: IHO Definition: **Definition required.**

Indication: The string encodes the location of a fragment of text or other information in a support file.

Example: **Clause 2.6**

Remarks:

- The attribute **file locator** indicates the location of a section of text within the file referenced by the attribute **file reference** that is relevant for a particular feature.
- The value populated for **file locator** may be a section heading; clause heading or number; page number, etc.

27.94 File reference (TXTDSC, NTXTDS)

File reference: IHO Definition: **Definition required.**

Indication: The string encodes the file name of a single external text file that contains the text.

Remarks:

- The attribute **file reference** indicates that a file containing text extracted from relevant pilot books or nautical publications is available.
- The attribute is generally used for long text strings or those that require formatting, however, there is no restriction on the type of text (except for lexical level) that can be held in files referenced by **file reference**.

27.95 Flare stack

Flare stack: IHO Definition: A statement expressing whether an offshore platform has a stack used for burning-off waste oil or gas or not.

Indication: Boolean. A True value is an indication that the offshore platform contains a flare stack.

Remarks:

- No remarks.

27.96 Flip bearing

Flip bearing: IHO Definition: The bearing at which text is re-located to the opposite side of a feature when screen display is oriented away from true north.

Unit: Degree (°)

Resolution: 1°

Format: xxx

Minimum value: 0

Maximum value: 360

Example: **180** for a flip bearing of 180 degrees

Remarks:

- No remarks.

27.97 Frequency shore station receives (SIGFRQ)

Frequency shore station receives: IHO Definition: The frequency of a signal transmitted to shore. (Adapted from S-57 Edition 3.1, Appendix A – Chapter 2, Page 2.187, November 2000).

Unit: Hertz (Hz)

Resolution: 1 Hz

Format: xxxxxxxxxxxx

Example: **95000000** for a radio signal centred on 950 MHz

Remarks:

- No remarks.

27.98 Frequency shore station transmits (SIGFRQ)

Frequency shore station transmits: IHO Definition: The frequency of a signal transmitted from shore. (Adapted from S-57 Edition 3.1, Appendix A – Chapter 2, Page 2.187, November 2000).

Unit: Hertz (Hz)

Resolution: 1 Hz

Format: xxxxxxxxxxxx

Example: **95000000** for a radio signal centred on 950 MHz

Remarks:

- No remarks.

27.99 Function (FUNCTN)

Function: IHO Definition: Definition required.

2) **Harbour-masters office**

IHO Definition: Local official who has charge of mooring and berthing of vessels, collecting harbour fees, etc. (Adapted from IHO Dictionary – S-32).

3) **Custom office**

IHO Definition: Serves as a government office where customs duties are collected, the flow of goods are regulated and restrictions enforced, and shipments or vehicles are cleared for entering or leaving a country. (Adapted from Defence Geospatial Information Working Group; Feature Data Dictionary Register, 2010).

4) **Health office**

IHO Definition: The office which is charged with the administration of health laws and sanitary inspections. (Adapted from The New Shorter Oxford English Dictionary, 1993).

5) **Hospital**

IHO Definition: An institution or establishment providing medical or surgical treatment for the ill or wounded. (The New Shorter Oxford English Dictionary, 1993).

6) **Post office**

IHO Definition: The public department, agency or organisation responsible primarily for the collection, transmission and distribution of mail. (The New Shorter Oxford English Dictionary, 1993).

7) **Hotel**

IHO Definition: An establishment, especially of a comfortable or luxurious kind, where paying visitors are provided with accommodation, meals and other services. (The New Shorter Oxford English Dictionary, 1993).

8) **Railway station**

IHO Definition: A building with platforms where trains arrive, load, discharge and depart. (The New Shorter Oxford English Dictionary, 1993).

9) **Police station**

IHO Definition: The headquarters of a local police force and that is where those under arrest are first charged. (Defence Geospatial Information Working Group; Feature Data Dictionary Register, 2010).

10) **Water-police station**

IHO Definition: The headquarters of a local water-police force. (Defence Geospatial Information Working Group; Feature Data Dictionary Register, 2010).

11) **Pilot office**

IHO Definition: The office or headquarters of pilots; the place where the services of a pilot may be obtained. (IHO Dictionary – S-32).

12) **Pilot lookout**

IHO Definition: A distinctive structure on shore from which personnel keep watch upon events at sea or along the coast. (IHO Dictionary – S-32).

13) **Bank office**

IHO Definition: An office for custody, deposit, loan, exchange or issue of money. (Adapted from The New Shorter Oxford English Dictionary, 1993).

14) **Headquarters for district control**

IHO Definition: The quarters of an executive officer (director, manager, etc.) with responsibility for an administrative area. (S-57 Edition 3.1, Appendix A – Chapter 2, Page 2.132, November 2000).

15) Transit shed/warehouse

IHO Definition: A building or part of a building for storage of wares or goods. (Adapted from The New Shorter Oxford English Dictionary, 1993).

16) Factory

IHO Definition: A building or buildings with equipment for manufacturing; a workshop. (The New Shorter Oxford English Dictionary, 1993).

17) Power station

IHO Definition: A stationary plant containing apparatus for large scale conversion of some form of energy (such as hydraulic, steam, chemical or nuclear energy) into electrical energy. (McGraw-Hill Dictionary of Scientific and Technical Terms, 3rd Edition, 1984).

18) Administrative

IHO Definition: A building for the management of affairs. (Adapted from The New Shorter Oxford English Dictionary, 1993).

19) Educational facility

IHO Definition: An establishment for teaching and learning (for example school, college, university, etc.). (Adapted from Defence Geospatial Information Working Group; Feature Data Dictionary Register, 2010).

20) Church

IHO Definition: A building for public Christian worship. (The New Shorter Oxford English Dictionary, 1993).

21) Chapel

IHO Definition: A place for Christian worship other than a parish, cathedral or church, especially one attached to a private house or institution. (The New Shorter Oxford English Dictionary, 1993).

22) Temple

IHO Definition: A building for public Jewish worship. (Adapted from The New Shorter Oxford English Dictionary, 1993).

23) Pagoda

IHO Definition: A Hindu or Buddhist temple or sacred building. (The New Shorter Oxford English Dictionary, 1993).

24) Shinto shrine

IHO Definition: A building for public Shinto worship. (Adapted from The New Shorter Oxford English Dictionary, 1993).

25) Buddhist temple

IHO Definition: See pagoda..

26) Mosque

IHO Definition: A Muslim place of worship. (The New Shorter Oxford English Dictionary, 1993).

27) Marabout

IHO Definition: A shrine marking the burial place of a Muslim holy man. (The New Shorter Oxford English Dictionary, 1993).

28) Lookout

IHO Definition: Keeping a watch upon events at sea or along the coast. (Adapted from IHO Dictionary – S-32).

29) Communication

IHO Definition: Transmitting and/or receiving electronic communication signals. (Defence Geospatial Information Working Group; Feature Data Dictionary Register, 2010).

30) Television

IHO Definition: A system for reproducing on a screen visual images transmitted (usually with sound) by radio signals. (Defence Geospatial Information Working Group; Feature Data Dictionary Register, 2010).

31) Radio

IHO Definition: Transmitting and/or receiving radio-frequency electromagnetic waves as a means of communication. (Defence Geospatial Information Working Group; Feature Data Dictionary Register, 2010).

32) Radar

IHO Definition: A method, system or technique of using beamed, reflected, and timed radio waves for detecting, locating, or tracking features, and for measuring altitudes. (IHO Dictionary – S-32).

33) Light support

IHO Definition: A structure serving as a support for one or more lights. (Defence Geospatial Information Working Group; Feature Data Dictionary Register, 2010).

34) Microwave

IHO Definition: Broadcasting and receiving signals using microwaves. (S-57 Edition 3.1, Appendix A – Chapter 2, Page 2.133, November 2000).

35) Cooling

IHO Definition: Generation of chilled liquid and/or gas for cooling purposes. (Defence Geospatial Information Working Group; Feature Data Dictionary Register, 2010).

36) Observation

IHO Definition: A place from which the surroundings can be observed but at which a watch is not habitually maintained. (Adapted from IHO Dictionary – S-32).

37) Timeball

IHO Definition: A visual time signal in the form of a ball. (IHO Dictionary – S-32).

38) Clock

IHO Definition: Instrument for measuring time and recording hours. (IHO Dictionary – S-32).

39) Control

IHO Definition: Used to control the flow of traffic within a specified range of an installation. (Defence Geospatial Information Working Group; Feature Data Dictionary Register, 2010).

40) Airship mooring

IHO Definition: Equipment or structure to secure an airship. (Adapted from Defence Geospatial Information Working Group; Feature Data Dictionary Register, 2010).

41) Stadium

IHO Definition: An arena for holding and viewing events. (Defence Geospatial Information Working Group; Feature Data Dictionary Register, 2010).

42) Bus station

IHO Definition: A building where buses and coaches regularly stop to take on and/or let off passengers, especially for long-distance travel. (Defence Geospatial Information Working Group; Feature Data Dictionary Register, 2010).

44) Sea rescue control

IHO Definition: A unit responsible for promoting efficient organization of search and rescue services and for coordinating the conduct of search and rescue operations within a search and rescue region. (Defence Geospatial Information Working Group; Feature Data Dictionary Register, 2010).

45) Observatory

IHO Definition: A building designed and equipped for making observations of astronomical, meteorological, or other natural phenomena. (Defence Geospatial Information Working Group; Feature Data Dictionary Register, 2010).

46) Ore crusher

IHO Definition: A building or structure used to crush ore.

47) Boathouse

IHO Definition: **Definition required.**

48) Pumping station

IHO Definition: A facility to move solids, liquids or gases by means of pressure or suction. (Defence Geospatial Information Working Group; Feature Data Dictionary Register, 2013).

Remarks:

- No remarks.

27.100 Headline

Headline: IHO Definition: Words set at the head of a passage or page to introduce or categorize. (Merriam-Webster Dictionary – 2012).

Indication: The string encodes the heading relevant to a text string or information contained in a support file.

Example: **Description of table format for S-101 meta and geo features**

Remarks:

- The attribute **headline** should contain no more than 100 characters.

27.101 Height (HEIGHT)

Height: IHO Definition: The value of the vertical distance to the highest point of the feature, measured from a specified vertical datum. (S-57 Edition 3.1, Appendix A – Chapter 2, Page 2.134, November 2000).

Unit: Defined as an attribute in the ENC dataset metadata: metre (m)

Resolution: 0.1m

Format: xxxx.x

Minimum value: 0

Example: **73** for a height of 73 metres

Remarks:

- Height must not be used for floating features.

27.102 Horizontal clearance length

Horizontal clearance length: IHO Definition: The length of a feature, such as a lock or basin, which is available for safe navigation. This may, or may not, be the same as the total physical length of the feature. (Adapted from S-57 Edition 3.1, Appendix A – Chapter 2, Page 2.137, November 2000).

Unit: Defined as an attribute in the ENC dataset metadata: metre (m)

Resolution: 0.1m

Format: xx.x

Example: **75** for a horizontal clearance length of 75 metres

Remarks:

- No remarks.

27.103 Horizontal clearance value (HORCLR)

Horizontal clearance value: IHO Definition: The width of a feature, such as a canal or a tunnel, which is available for safe navigation. This may, or may not, be the same as the total physical width of the feature. (S-57 Edition 3.1, Appendix A – Chapter 2, Page 2.137, November 2000).

Unit: Defined as an attribute in the ENC dataset metadata: metre (m)

Resolution: 0.1m

Format: xx.x

Example: **125** for a horizontal clearance of 125 metres

Remarks:

- No remarks.

27.104 Horizontal clearance width

Horizontal clearance width: IHO Definition: The width of a feature, such as a lock or basin, which is available for safe navigation. This may, or may not, be the same as the total physical width of the feature. (Adapted from S-57 Edition 3.1, Appendix A – Chapter 2, Page 2.137, November 2000).

Unit: Defined as an attribute in the ENC dataset metadata: metre (m)

Resolution: 0.1m

Format: xx.x

Example: **30** for a horizontal clearance width of 30 metres

Remarks:

- No remarks.

27.105 Horizontal length (HORLEN)

Horizontal length: IHO Definition: A measurement of the longer of two linear axis. (Defence Geospatial Information Working Group; Feature Data Dictionary Register, 2010).

Unit: Defined as an attribute in the ENC dataset metadata: metre (m)

Resolution: 0.1m

Format: xxx.x

Example: **95** for a length of 95 metres

Remarks:

- No remarks.

27.106 Horizontal width (HORWID)

Horizontal width: IHO Definition: A measurement of the shorter of two linear axis. (Defence Geospatial Information Working Group; Feature Data Dictionary Register, 2010).

Unit: Defined as an attribute in the ENC dataset metadata: metre (m)

Resolution: 0.1m

Format: xxx.x

Example: **12.6** for a width of 12.6 metres

Remarks:

- No remarks.

27.107 Ice factor (ICEFAC)

Ice factor: IHO Definition: The value of the maximum variation in the vertical clearance of an overhead cable due to an accumulation of ice. (S-57 Edition 3.1, Appendix A – Chapter 2, Page 2.140, November 2000).

Unit: Defined as an attribute in the ENC dataset metadata: metre (m)

Resolution: 0.1m

Format: xx.x

Example: **2.5** for a reduction of 2.5 metres in the vertical clearance.

Remarks:

- No remarks.

27.108 In dispute

In dispute: IHO Definition: **Definition required.**

Indication: Boolean. A True value is an indication that the area defined is in jurisdictional dispute.

Remarks:

- No remarks.

27.109 Is MRCC

Is MRCC: IHO Definition: **Definition required.**

Indication: Boolean. A True value is an indication that the encoded coastguard station performs the function of a Maritime Rescue and Coordination Centre.

Remarks:

- No remarks.

27.110 Jurisdiction (JRSDTN)

Jurisdiction: IHO Definition: The jurisdiction applicable to an administrative area. (S-57 Edition 3.1, Appendix A – Chapter 2, Page 2.142, November 2000).

1) International

IHO Definition: Involving more than one country; covering more than one national area. (S-57 Edition 3.1, Appendix A – Chapter 2, Page 2.142, November 2000).

2) National

IHO Definition: An area administered or controlled by a single nation. (S-57 Edition 3.1, Appendix A – Chapter 2, Page 2.142, November 2000).

3) National sub-division

IHO Definition: An area smaller than the nation in which it lies. (S-57 Edition 3.1, Appendix A – Chapter 2, Page 2.142, November 2000).

Remarks:

- No remarks.

27.111 Language

Language: IHO Definition: **Definition required.**

Indication: The language is encoded by a character code following ISO 639-3.

Format: c2 (**mandatory**)

Example: **GB** for English

Remarks:

- The attribute **language** indicates the language of the specific text.

27.112 Lifting capacity (LIFCAP)

Lifting capacity: IHO Definition: The specific safe lifting capacity of a feature. (S-57 Edition 3.1, Appendix A – Chapter 2, Page 2.145, November 2000).

Unit: Tonne (t)

Resolution: 0.1t

Format: xxx.x

Minimum value: 0

Example: **120** for a lifting capacity of 120 tonnes

Remarks:

- No remarks.

27.113 Light characteristic (LITCHR)

Light characteristic: IHO Definition: **Definition required.**

1) Fixed

IHO Definition: A signal light that shows continuously, in any given direction, with constant luminous intensity and colour. (IHO Dictionary – S-32).

2) Flashing

IHO Definition: A rhythmic light in which the total duration of light in a period is clearly shorter than the total duration of darkness and all the appearances of light are of equal duration. It may be:

- *Single flashing:* A flashing light in which a flash is regularly repeated at a rate of less than 50 flashes per minutes.
- *Group flashing:* A flashing light in which a group of two or more flashes, which are specified in number, is regularly repeated.
- *Group flashing:* A flashing light in which a group of two or more flashes, which one or more flashes, which are specified in number, is regularly repeated, and the groups comprise different numbers of flashes.

(IALA International Dictionary of Aids to Marine Navigation).

3) Long-flashing

IHO Definition: A single-flashing light in which an appearance of light of not less than two seconds duration is regularly repeated. (IALA International Dictionary of Aids to Marine Navigation).

4) Quick-flashing

IHO Definition: A rhythmic light in which flashes are repeated at a rate of not less than 50 flashes per minutes but less than 80 flashes per minutes. It may be:

- *Continuous quick-flashing*: A quick-flashing light in which a flash is regularly repeated.
 - *Group quick-flashing*: A quick-flashing light in which a group of two or more flashes, which are specified in number, is regularly repeated.
- (IALA International Dictionary of Aids to Marine Navigation).

5) **Very quick-flashing**

IHO Definition: A rhythmic light in which flashes are repeated at a rate of not less than 80 flashes per minute but less than 160 flashes per minute. It may be:

- *Continuous very quick-flashing*: A very quick-flashing light in which a flash is regularly repeated.
 - *Group very quick-flashing*: A very quick-flashing light in which a group of two or more flashes, which are specified in number, is regularly repeated.
- (IALA International Dictionary of Aids to Marine Navigation).

6) **Continuous ultra quick-flashing**

IHO Definition: A rhythmic light in which flashes are regularly repeated at a rate of not less than 160 flashes per minute. (IALA International Dictionary of Aids to Marine Navigation).

7) **Isophased**

IHO Definition: A light with all durations of light and darkness equal. (IHO Dictionary – S-32).

8) **Occulting**

IHO Definition: A rhythmic light in which the total duration of light in a period is clearly longer than the total duration of darkness and all the eclipses are of equal duration. It may be:

- *Single-occulting*: An occulting light in which an eclipse is regularly repeated.
- *Group-occulting*: An occulting light in which a group of two or more eclipses, which are specified in number, is regularly repeated.
- *Composite group-occulting*: An occulting light in which a sequence of groups of one or more eclipses, which are specified in number, is regularly repeated, and the groups comprise different numbers of eclipses.

(IALA International Dictionary of Aids to Marine Navigation).

11) **Interrupted ultra quick-flashing**

IHO Definition: A light in which the ultra quick flashes (160 or more per minute) are interrupted at regular intervals by eclipses of long duration. (IHO Dictionary – S-32).

12) **Morse**

IHO Definition: A rhythmic light in which appearances of light of two clearly different durations are grouped to represent a character or characters in the Morse code. (IHO Dictionary – S-32).

13) **Fixed and flash**

IHO Definition: A rhythmic light in which a fixed light is combined with a flashing light of higher luminous intensity. (IHO Dictionary – S-32).

14) **Flash and long flash**

IHO Definition: **Definition required.**

15) **Occulting and flash**

IHO Definition: **Definition required.**

16) **Fixed and long flash**

IHO Definition: **Definition required.**

17) **Occulting alternating**

IHO Definition: **Definition required.**

18) **Long-flash alternating**

IHO Definition: **Definition required.**

19) **Flash alternating**

IHO Definition: Definition required.

25) **Quick-flash plus long-flash**

IHO Definition: Definition required.

26) **Very quick-flash plus long flash**

IHO Definition: Definition required.

27) **Ultra quick-flash plus long-flash**

IHO Definition: Definition required.

28) **Alternating**

IHO Definition: A signal light that shows continuously, in any given direction, two or more colours in a regularly repeated sequence with a regular periodicity. (IALA International Dictionary of Aids to Marine Navigation).

29) **Fixed and alternating flashing**

IHO Definition: Definition required.

Remarks:

- A selection of the above characteristics is defined and illustrated diagrammatically in IHO Chart Specifications, S-4 – B-471.2.

27.114 Light visibility (LITVIS)

Light visibility: IHO Definition: Definition required.

1) **High intensity**

IHO Definition: Non-marine lights with a higher power than marine lights and visible from well off shore (often "Aero" lights). (S-57 Edition 3.1, Appendix A – Chapter 2, Page 2.148, November 2000).

2) **Low intensity**

IHO Definition: Non-marine lights with lower power than marine lights. (Bundesamt für Seeschifffahrt und Hydrographie, Germany).

3) **Faint**

IHO Definition: A decrease in the apparent intensity of a light which may occur in the case of partial obstructions. (S-57 Edition 3.1, Appendix A – Chapter 2, Page 2.148, November 2000).

4) **Intensified**

IHO Definition: A light in a sector is intensified (that is, has longer range than other sectors). (Bundesamt für Seeschifffahrt und Hydrographie, Germany).

5) **Unintensified**

IHO Definition: A light in a sector is unintensified (that is, has shorter range than other sectors). (Bundesamt für Seeschifffahrt und Hydrographie, Germany).

6) **Visibility deliberately restricted**

IHO Definition: A light sector is deliberately reduced in intensity, for example to reduce its effect on a built-up area. (S-57 Edition 3.1, Appendix A – Chapter 2, Page 2.148, November 2000).

7) **Obscured**

IHO Definition: Said of the arc of a light sector designated by its limiting bearings in which the light is not visible from seaward. (IHO Dictionary – S-32).

8) **Partially obscured**

IHO Definition: This value specifies that parts of the sector are obscured.. (S-57 Edition 3.1, Appendix A – Chapter 2, Page 2.148, November 2000).

9) Visible in line of range

IHO Definition: Lights that must be in line to be visible..

Remarks:

- The attribute “light visibility” encodes the specific visibility of a light, with respect to the light’s intensity and ease of recognition.

27.115 Linkage

Linkage: IHO Definition: Location (address) for online access using a URL/URI address or similar addressing scheme. (Adapted from ISO 19115-1:2014).

Indication:

Format: URL address or equivalent

Example: http://www.iho.int

Remarks:

- No remarks.

27.116 Magnetic anomaly value maximum (VALLMA)

Magnetic anomaly value maximum: IHO Definition: The maximum value of the deviation from the normal magnetic variation. (S-57 Edition 3.1, Appendix A – Chapter 2, Page 2.228, November 2000).

Unit: minute (’)

Resolution: 0.1’

Format: xxx.x

Example: **30.3** for a deviation of 30.3 minutes

Remarks:

- The deviation is assumed to be positive and negative. The plus/minus character must not be encoded.

27.117 Magnetic anomaly value minimum

Magnetic anomaly value minimum: IHO Definition: The negative value of the deviation from the normal magnetic variation. (Adapted from S-57 Edition 3.1, Appendix A – Chapter 2, Page 2.228, November 2000).

Unit: minute (’)

Resolution: 0.1’

Format: xxx.x

Example: **25.5** for a deviation of 25.5 minutes in a westerly direction

Remarks:

- The deviation is assumed to be negative. The minus character must not be encoded.

27.118 Major light

Major light: IHO Definition: A statement expressing if a light is considered to be a major light in terms of ECDIS display in a particular area.

Indication: Boolean. A True value is an indication that the light is considered to be a major light.

Remarks:

- The attribute **major light** is only intended to provide an indication to the ECDIS that the light is considered

to be an important light in terms of its display. As such this is a cartographic attribute to aid the compiler in determining the most appropriate display for a light; it is not intended to be used as a formal classification method for lights.

27.119 Marks navigational – system of (MARSYS)

Marks navigational – system of: IHO Definition: **Definition required.**

1) **IALA A**

IHO Definition: Navigational aids conform to the International Association of Lighthouse Authorities - IALA A system. (S-57 Edition 3.1, Appendix A – Chapter 2, Page 2.149, November 2000).

2) **IALA B**

IHO Definition: Navigational aids conform to the International Association of Lighthouse Authorities - IALA B system. (S-57 Edition 3.1, Appendix A – Chapter 2, Page 2.149, November 2000).

9) **No system**

IHO Definition: Navigational aids do not conform to any defined system. (S-57 Edition 3.1, Appendix A – Chapter 2, Page 2.149, November 2000).

11) **CEVNI**

IHO Definition: **Definition required.**

Remarks:

- No remarks.

27.120 Maximum permitted draught

Maximum permitted draught: IHO Definition: The maximum draught of a vessel permitted along a route, in a channel or dock, at a berth, or over a submerged feature.

Unit: Defined as an attribute in the ENC dataset metadata: metre (m)

Resolution: 0.1m

Format: xx.x

Example: **14.5** for a maximum permitted draught of 14.5 metres

Remarks:

- No remarks.

27.121 Measured distance

Measured distance: IHO Definition: An accurately defined distance along a course at sea.

Unit: Defined as an attribute in the ENC dataset metadata: metre (m)

Resolution: 1m

Format: xxxx

Example: **1445** for a measured distance of 1445 metres

Remarks:

- No remarks.

27.122 MMSI code

MMSI code: IHO Definition: The Maritime Mobile Service Identity (MMSI) Code is formed of a series of nine digits which are transmitted over the radio path in order to uniquely identify ship stations, ship earth stations, coast stations, coast earth stations, and group calls. These identities are formed in such a way that the identity or part thereof can be used by telephone and telex subscribers connected to the general telecommunications network principally to call ships automatically. (Adapted from Appendix 43 of the International Telecommunications Union Radio Regulations).

Unit: None.

Resolution: 1

Format: xxxxxxxxx

Example: 366777490

Remarks:

- No remarks.

27.123 Moiré effect

Moiré effect: IHO Definition: A short range (up to 2km) type of directional light. Sodium lighting gives a yellow background to a screen on which a vertical black line will be seen by an observer on the centre line. (S-57 Edition 3.1, Appendix A – Chapter 2, Page 2.49, November 2000).

Indication: Boolean. A True value is an indication that the encoded light is a moiré effect light.

Remarks:

- No remarks.

27.124 Multiplicity known

Multiplicity known: IHO Definition: The number of features of identical character that exist as a co-located group is or is not known. (Adapted from S-57 Edition 3.1, Appendix A – Chapter 2, Page 2.150, November 2000).

Indication: Boolean. A True value is an indication that the exact number of features is known.

Remarks:

- No remarks.

27.125 Name (*OBJNAM, NOBJNM*)

Name: IHO Definition: The individual name of a feature. (S-57 Edition 3.1, Appendix A – Chapter 2, Page 2.158, November 2000).

Indication: Name of feature (c...): String of characters.

Format: c...

Example:

Remarks:

- The attribute **name** encodes the individual name of a feature.

27.126 Name of resource

Name of resource: IHO Definition: The name of an online resource. (ISO 19115).

Indication: String of characters.

Format: c...

Example:

Remarks:

- The attribute **name of resource** encodes the name of an online resource. The URL/URI for accessing the resource is populated using the attribute **linkage**.

27.127 Nationality (NATION)

Nationality: IHO Definition: **Definition required.**

Indication: The nationality is encoded by a 2 character code following ISO 3166 (refer to S-57 Appendix A).

Format: c2 (**mandatory**)

Example: **AU** for Australia
CA,US for Canada and the United States of America

Remarks:

- The attribute “nationality” indicates the nationality of the specific feature.
- Where it is required to encode multiple nationalities relevant to a single feature (for example, for a maritime jurisdiction area that is in dispute between two Coastal States), this must be done by populating the character codes for both Coastal States, delimited by a comma.

27.128 Nature of construction (NATCON)

Nature of construction: IHO Definition: **Definition required.**

1) **Masonry**

IHO Definition: Constructed of stones or bricks, usually quarried, shaped, and mortared. (Adapted from Defence Geospatial Information Working Group; Feature Data Dictionary Register, 2010).

2) **Concreted**

IHO Definition: Constructed of concrete, a material made of sand and gravel that is united by cement into a hardened mass used for roads, foundations, etc. (Adapted from the Illustrated Contemporary Dictionary, Encyclopedic Edition, 1978).

3) **Loose boulders**

IHO Definition: Constructed from large stones or blocks of concrete, often placed loosely for protection against waves or water turbulence. (S-57 Edition 3.1, Appendix A – Chapter 2, Page 2.152, November 2000).

4) **Hard surfaced**

IHO Definition: Constructed with a surface of hard material, usually a term applied to roads surfaced with asphalt or concrete. (S-57 Edition 3.1, Appendix A – Chapter 2, Page 2.152, November 2000).

5) **Unsurfaced**

IHO Definition: Constructed with no extra protection, usually a term applied to roads not surfaced with a hard material. (S-57 Edition 3.1, Appendix A – Chapter 2, Page 2.152, November 2000).

6) **Wooden**

IHO Definition: Constructed from wood. (S-57 Edition 3.1, Appendix A – Chapter 2, Page 2.152, November 2000).

7) **Metal**

IHO Definition: Constructed from metal. (S-57 Edition 3.1, Appendix A – Chapter 2, Page 2.152,

November 2000).

8) **Glass reinforced plastic (GRP)**

IHO Definition: Constructed from a plastic material strengthened with fibres of glass. (S-57 Edition 3.1, Appendix A – Chapter 2, Page 2.152, November 2000).

11) **Latticed**

IHO Definition: Definition required.

12) **Glass**

IHO Definition: Definition required.

Remarks:

- No remarks.

27.129 Nature of surface (NATSUR)

Nature of surface: IHO Definition: Definition required.

1) **Mud**

IHO Definition: Soft, wet earth. (S-57 Edition 3.1, Appendix A – Chapter 2, Page 2.153, November 2000).

2) **Clay**

IHO Definition: (Particles of less than 0.002mm); stiff, sticky earth that becomes hard when baked. (S-57 Edition 3.1, Appendix A – Chapter 2, Page 2.153, November 2000).

3) **Silt**

IHO Definition: An unconsolidated sediment whose particles range in size from 0.0039 to 0.0625 millimetres in diameter (between clay and sand size). (IHO Dictionary – S-32).

4) **Sand**

IHO Definition: Loose material consisting of small but easily distinguishable, separate grains, between 0.0625 and 2.000 millimetres in diameter. (IHO Dictionary – S-32).

5) **Stone**

IHO Definition: A general term for rock fragments ranging in size from pebbles and gravel to boulders or large rock masses. (IHO Dictionary – S-32).

6) **Gravel**

IHO Definition: (Particles of 2.0-4.0mm); small stones with coarse sand. (S-57 Edition 3.1, Appendix A – Chapter 2, Page 2.153, November 2000).

7) **Pebbles**

IHO Definition: A small stone worn smooth and rounded by the action of water, sand, ice, etc. ranging in diameter between 4 and 64 millimetres. (IHO Dictionary – S-32).

8) **Cobbles**

IHO Definition: A naturally rounded stone larger than a pebble. (IHO Dictionary – S-32).

9) **Rock**

IHO Definition: Any formation of natural origin that constitutes an integral part of the lithosphere. The natural occurring material that forms firm, hard, and solid masses. (Adapted from IHO Dictionary – S-32).

11) **Lava**

IHO Definition: The fluid or semi-fluid matter flowing from a volcano. The substance that results from the cooling of the molten rock. Part of the ocean bed is composed of lava. (IHO Dictionary – S-32).

14) Coral

IHO Definition: Hard calcareous skeletons of many tribes of marine polyps. (IHO Dictionary – S-32).

17) Shells

IHO Definition: Exoskeletons of various water dwelling animals. (Adapted from IHO Dictionary – S-32).

18) Boulder

IHO Definition: A rounded rock with diameter of 256 mm or larger. (Adapted from IHO Dictionary – S-32).

Remarks:

- The attribute “nature of surface” encodes the general nature of the material of which the land surface or the seabed is composed.
- Mixed bottom: where the seabed comprises a mixture of material, the main constituent is given first for example fine sand with mud and shells would be indicated as 4,1,17.
- Mud, sand, stone, rock are terms used for the general description. Clay, silt, gravel, pebbles, cobbles are more specific terms related to particle size.

27.130 Nature of surface – qualifying terms (NATQUA)

Nature of surface – qualifying terms: IHO Definition: **Definition required.**

1) Fine

IHO Definition: Falls within the smallest size continuum for a particular nature of surface term. (S-57 Edition 3.1, Appendix A – Chapter 2, Page 2.155, November 2000).

2) Medium

IHO Definition: Falls within the moderate size continuum for a particular nature of surface term. (S-57 Edition 3.1, Appendix A – Chapter 2, Page 2.155, November 2000).

3) Coarse

IHO Definition: Falls within the largest size continuum for a particular nature of surface term. (S-57 Edition 3.1, Appendix A – Chapter 2, Page 2.155, November 2000).

4) Broken

IHO Definition: Fractured or in pieces. (Adapted from Webster’s II New Riverside Dictionary, 1984).

5) Sticky

IHO Definition: Having an adhesive or glue like property. (Adapted from Webster’s II New Riverside Dictionary, 1984).

6) Soft

IHO Definition: Not hard or firm. (Adapted from Webster’s II New Riverside Dictionary, 1984).

7) Stiff

IHO Definition: Not pliant; thick, resistant to flow. (Adapted from Webster’s II New Riverside Dictionary, 1984).

8) Volcanic

IHO Definition: Composed of or containing material ejected from a volcano. (Adapted from Webster’s II New Riverside Dictionary, 1984).

9) Calcareous

IHO Definition: Composed of or containing calcium or calcium carbonate. (IHO Dictionary – S-32).

10) Hard

IHO Definition: Firm; usually refers to an area of the sea floor not covered by unconsolidated sediment.

(IHO Dictionary – S-32 and adapted from Webster’s II New Riverside Dictionary, 1984).

Remarks:

- The attribute “nature of surface - qualifying terms” encodes the nature of various forms of natural surface materials in terms of their size, morphology and consistency.

27.131 Number of features

Number of features: IHO Definition: The number of features of identical character that exist as a co-located group. (Adapted from S-57 Edition 3.1, Appendix A – Chapter 2, Page 2.150, November 2000).

Unit: None

Resolution: 1

Format: xx

Example: **3** for 3 co-located cables

Remarks:

- The attribute **number of features** must only be used to indicate the number of entities of a feature, where known, that are co-located (for example 3 overhead cables suspended over a body of water between 2 pylons), and this information is considered to be of use to the mariner. Where possible, features must be encoded individually.

27.132 Observation depth

Observation depth: IHO Definition: The depth at which a set of tidal stream observations is taken.

Unit: Defined as an attribute in the ENC dataset metadata: metre (m)

Resolution: 0.1m

Format: xx.x

Example: **25** for a depth of 25 metres

Remarks:

- No remarks.

27.133 Orientation value (ORIENT)

Orientation: IHO Definition: The angular distance measured from true north to the major axis of the feature. (Defence Geospatial Information Working Group; Feature Data Dictionary Register, 2010).

Unit: Degree (°)

Resolution: 0.01°

Format: xxx.xx

Minimum value: 0

Maximum value: 360

Example: **246.7** for an orientation of 246.7 degrees

27.134 Pictorial representation (PICREP)

Pictorial representation: IHO Definition: Indicates whether a pictorial representation of the feature is available. (S-57 Edition 3.1, Appendix A – Chapter 2, Page 2.162, November 2000).

Indication: The string encodes the file name of a single external graphic file (pixel/vector).

Remarks:

- The “pictorial representation” could be a drawing or a photo.

27.135 Product (PRODCCT)

Product: IHO Definition: **Definition required.**

1) **Oil**

IHO Definition: A thick, slippery liquid that will not dissolve in water, usually petroleum based in the context of storage tanks. (Adapted from the Oxford Minidictionary, Third Edition).

2) **Gas**

IHO Definition: A substance with particles that can move freely, usually a fuel substance in the context of storage tanks. (Adapted from the Oxford Minidictionary, Third Edition).

3) **Water**

IHO Definition: A colourless, odourless, tasteless liquid that is a compound of hydrogen and oxygen. (Adapted from the Oxford Minidictionary, Third Edition).

4) **Stone**

IHO Definition: A general term for rock fragments. (IHO Dictionary – S-32).

5) **Coal**

IHO Definition: A hard black mineral that is burned as fuel. (Adapted from the Oxford Minidictionary, Third Edition).

6) **Ore**

IHO Definition: A solid rock or mineral from which metal is obtained. (Adapted **from** the Oxford Minidictionary, Third Edition).

7) **Chemicals**

IHO Definition: Any substance obtained by or used in a chemical process. (Adapted from the Oxford Minidictionary, Third Edition).

8) **Drinking water**

IHO Definition: Water that is suitable for human consumption. (Adapted from the Oxford Minidictionary, Third Edition).

9) **Milk**

IHO Definition: A white fluid secreted by female mammals as food for their young. (Adapted from the Oxford Minidictionary, Third Edition).

10) **Bauxite**

IHO Definition: A mineral from which aluminum is obtained. (Adapted from the Oxford Minidictionary, Third Edition).

11) **Coke**

IHO Definition: A solid substance obtained after gas and tar have been extracted from coal, used as a fuel. (Adapted from the Oxford Minidictionary, Third Edition).

12) **Iron ingots**

IHO Definition: An oblong lump of cast iron metal. (Adapted from the Oxford Minidictionary, Third Edition).

13) **Salt**

IHO Definition: Sodium chloride obtained from mines or by the evaporation of sea water. (Adapted from

the Oxford Minidictionary, Third Edition).

14) **Sand**

IHO Definition: Tiny grains of crushed or worn rock. (Adapted from the Oxford Minidictionary, Third Edition).

15) **Timber**

IHO Definition: Wood prepared for use in building or carpentry. (Adapted from the Oxford Minidictionary, Third Edition).

16) **Sawdust/wood chips**

IHO Definition: Powdery fragments of wood made in sawing timber or coarse chips produced for use in manufacturing pressed board. (Adapted from the Oxford Minidictionary, Third Edition).

17) **Scrap metal**

IHO Definition: Discarded metal suitable for being reprocessed. (Adapted from the Oxford Minidictionary, Third Edition).

18) **Liquefied natural gas (LNG)**

IHO Definition: Natural gas that has been liquefied for ease of transport by cooling the gas to -162 Celsius. (Defence Geospatial Information Working Group; Feature Data Dictionary Register, 2010).

19) **Liquefied petroleum gas (LPG)**

IHO Definition: A compressed gas consisting of flammable light hydrocarbons and derived from petroleum. (Adapted from the Websters New World Dictionary).

20) **Wine**

IHO Definition: The fermented juice of grapes. (Adapted from the Websters New World Dictionary).

21) **Cement**

IHO Definition: A substance made of powdered lime and clay, mixed with water. (Adapted from the Websters New World Dictionary).

22) **Grain**

IHO Definition: A small hard seed, especially that of any cereal plant such as wheat, rice, corn, rye etc. (Adapted from the Websters New World Dictionary).

23) **Electricity**

IHO Definition: **Definition required.**

24) **Ice**

IHO Definition: Frozen water.

25) **Clay**

IHO Definition: (Particles of less than 0.002mm); stiff, sticky earth that becomes hard when baked. (S-57 Edition 3.1, Appendix A – Chapter 2, Page 2.153, November 2000).

Remarks:

- The attribute “product” encodes the various substances which are transported, stored or exploited.

27.136 Quality of vertical measurement (QUASOU)

Quality of vertical measurement: IHO Definition: **Definition required.**

1) **Depth known**

IHO Definition: The depth from the chart datum to the seabed (or to the top of a drying feature) is known. (Adapted from Defence Geospatial Information Working Group; Feature Data Dictionary Register, 2010).

2) Depth or least depth unknown

IHO Definition: The depth from chart datum to the seabed, or the shoalest depth of the feature is unknown. (S-57 Edition 3.1, Appendix A – Chapter 2, Page 2.169, November 2000, as amended).

3) Doubtful sounding

IHO Definition: A depth that may be less than indicated. (Adapted from IHO Dictionary – S-32).

4) Unreliable sounding

IHO Definition: A depth that is considered to be an unreliable value. (S-57 Edition 3.1, Appendix A – Chapter 2, Page 2.169, November 2000).

6) Least depth known

IHO Definition: The shoalest depth over a feature is of known value. (Adapted from IHO Dictionary – S-32).

7) Least depth unknown, safe clearance at value shown

IHO Definition: The least depth over a feature is unknown, but there is considered to be safe clearance at this depth. (S-57 Edition 3.1, Appendix A – Chapter 2, Page 2.169, November 2000).

8) Value reported (not surveyed)

IHO Definition: Depth value obtained from a report, but not fully surveyed. (S-57 Edition 3.1, Appendix A – Chapter 2, Page 2.169, November 2000).

9) Value reported (not confirmed)

IHO Definition: Depth value obtained from a report, which it has not been possible to confirm. (S-57 Edition 3.1, Appendix A – Chapter 2, Page 2.169, November 2000).

10) Maintained depth

IHO Definition: The depth at which a channel is kept by human influence, usually by dredging. (IHO Dictionary – S-32).

11) Not regularly maintained

IHO Definition: Depths may be altered by human influence, but will not be routinely maintained. (S-57 Edition 3.1, Appendix A – Chapter 2, Page 2.169, November 2000).

Remarks:

- The attribute **quality of vertical measurement** indicates the reliability of the value of sounding.

27.137 Radar band

Radar band: IHO Definition: The band code character of the electromagnetic spectrum within which radar wave lengths lie.

Indication: Radar band (C).

Format: C

Example: X for the (X) - Band.

Remarks:

- Radar transponder beacons generally work on the 3cm (X) – Band or the 10cm (S) – Band wave lengths. Nevertheless, wave lengths outside the marine band are used.

27.138 Radar conspicuous (CONRAD)

Radar conspicuous: IHO Definition: A feature which returns a strong radar echo. (IHO Dictionary, S-32).

Indication: Boolean. A True value is an indication that the feature returns a strong radar echo.

Remarks:

- **Radar conspicuous** applies to both features that themselves provide a strong radar echo; or return a strong radar echo as a result of being fitted with a radar reflector or a Radar Target Enhancer.

27.139 Radius (RADIUS)

Radius: IHO Definition: The vector extending from the centre to the periphery of a circular or spherical feature. (Adapted from S-57 Edition 3.1, Appendix A – Chapter 2, Page 2.173, November 2000).

Unit: Defined as an attribute in the ENC dataset metadata: metre (m)

Resolution: 0.1m

Format: xxx.x

Example: **26** for a radius of 26 metres

Remarks:

- No remarks.

27.140 Reference location

Reference location: IHO Definition: Information relating to the point of origin for a measured distance as indicated on a distance mark.

Indication: Reference location (c...).

Format: c...

Example: **Storey Bridge** for a distance mark marking a specified distance from Storey Bridge.

Remarks:

- No remarks.

27.141 Reference tide

Reference tide: IHO Definition: The reference tide to which the series of tidal stream values apply.

1) High water

IHO Definition: (H.W.). The highest level reached at a place by the water surface in one oscillation. Also called high tide.

2) Low water

IHO Definition: (L.W.). The lowest level reached at a place by the water surface in one oscillation. Also called low tide.

Remarks:

- No remarks.

27.142 Reference tide type

Reference tide type: IHO Definition: The type of tide range (that is, mean spring tide, mean neap tide or mean tide) for which a set of tidal stream rates and directions apply.

1) Springs

IHO Definition: The tides of increased range occurring near the times of full moon and new moon.

2) Neaps

IHO Definition: The tides of decreased range occurring near the times of first and last quarter.

3) Mean

IHO Definition: The tides of mean range occurring between spring and neap tides.

Remarks:

- No remarks.

27.143 Reference year of magnetic variation (RYRMGV)

Reference year for magnetic variation: IHO Definition: The reference calendar year for magnetic variation values. (S-57 Edition 3.1, Appendix A – Chapter 2, Page 2.176, November 2000).

Unit: Four digit year indication (YYYY)

Format: YYYY----

Example: **2009----**

Remarks:

- The dashes (----) must be included in all cases.

27.144 Regulation citation

Regulation citation: IHO Definition: The regulation citation for the feature.

Indication: Regulation citation (c...).

Format: c...

Example: **CFR 33.88.810**

Remarks:

- No remarks.

27.145 Reported date

Date start: IHO Definition: **Definition required.**

Indication: The **reported date** should be encoded using 4 digits for the calendar year (YYYY), 2 digits for the month (MM) (for example April = 04) and 2 digits for the day (DD). When no specific month and/or day is required/known, indication of the month and/or day is omitted, and replaced with dashes (-).

This conforms to ISO 8601:2004.

Format: YYYYMMDD (full date, **mandatory**)
 YYYYMM-- (no specific day required – **mandatory**)
 YYYY---- (no specific month required – **mandatory**)

Example: **20101129** for 29 November 2010 as starting date.

Remarks:

- The attribute **reported date** indicates the date that information regarding a feature has been supplied to a Producing Authority.

27.146 Restriction (RESTRN)

Restriction: IHO Definition: **Definition required.**

1) Anchoring prohibited

IHO Definition: An area within which anchoring is not permitted. (S-57 Edition 3.1, Appendix A – Chapter 2, Page 2.177, November 2000).

2) Anchoring restricted

IHO Definition: A specified area designated by appropriate authority, within which anchoring is restricted in accordance with certain specified conditions. An area within which anchoring is not permitted. (S-57 Edition 3.1, Appendix A – Chapter 2, Page 2.177, November 2000).

3) Fishing prohibited

IHO Definition: An area within which fishing is not permitted. An area within which anchoring is not permitted. (S-57 Edition 3.1, Appendix A – Chapter 2, Page 2.177, November 2000).

4) Fishing restricted

IHO Definition: A specified area designated by appropriate authority, within which fishing is restricted in accordance with certain specified conditions. An area within which anchoring is not permitted. (S-57 Edition 3.1, Appendix A – Chapter 2, Page 2.177, November 2000).

5) Trawling prohibited

IHO Definition: An area within which trawling is not permitted. An area within which anchoring is not permitted. (S-57 Edition 3.1, Appendix A – Chapter 2, Page 2.177, November 2000).

6) Trawling restricted

IHO Definition: A specified area designated by appropriate authority, within which trawling is restricted in accordance with certain specified conditions. An area within which anchoring is not permitted. (S-57 Edition 3.1, Appendix A – Chapter 2, Page 2.178, November 2000).

7) Entry prohibited

IHO Definition: An area within which navigation and/or anchoring is prohibited. (Adapted from IHO Dictionary – S-32).

8) Entry restricted

IHO Definition: A specified area designated by appropriate authority, within which navigation is restricted in accordance with certain specified conditions. (Adapted from IHO Dictionary – S-32).

9) Dredging prohibited

IHO Definition: An area within which dredging is not permitted. (S-57 Edition 3.1, Appendix A – Chapter 2, Page 2.178, November 2000).

10) Dredging restricted

IHO Definition: A specified area designated by appropriate authority, within which dredging is restricted in accordance with certain specified conditions. (S-57 Edition 3.1, Appendix A – Chapter 2, Page 2.178, November 2000).

11) Diving prohibited

IHO Definition: An area within which diving is not permitted. (S-57 Edition 3.1, Appendix A – Chapter 2, Page 2.178, November 2000).

12) Diving restricted

IHO Definition: A specified area designated by appropriate authority, within which diving is restricted in accordance with certain specified conditions. (S-57 Edition 3.1, Appendix A – Chapter 2, Page 2.178, November 2000).

13) No wake

IHO Definition: Mariners must adjust the speed of their vessels to reduce the wave or wash which may cause erosion or disturb moored vessels. (S-57 Edition 3.1, Appendix A – Chapter 2, Page 2.178, November 2000).

14) Area to be avoided

IHO Definition: An IMO declared routeing measure comprising an area within defined limits in which either navigation is particularly hazardous or it is exceptionally important to avoid casualties and which should be avoided by all ships, or certain classes of ships. (Adapted from IHO Dictionary – S-32).

15) Construction prohibited

IHO Definition: The erection of permanent or temporary fixed structures or artificial islands is prohibited. (S-57 Edition 3.1, Appendix A – Chapter 2, Page 2.178, November 2000).

16) Discharging prohibited

IHO Definition: An area within which discharging or dumping is prohibited. (S-57 Edition 3.1, Appendix A – Chapter 2, Page 2.178, November 2000).

17) Discharging restricted

IHO Definition: A specified area designated by an appropriate authority, within which discharging or dumping is restricted in accordance with specified conditions. (S-57 Edition 3.1, Appendix A – Chapter 2, Page 2.178, November 2000).

18) Industrial or mineral exploration/development prohibited

IHO Definition: An area within which industrial or mineral exploration and development are prohibited. (S-57 Edition 3.1, Appendix A – Chapter 2, Page 2.178, November 2000).

19) Industrial or mineral exploration/development restricted

IHO Definition: A specified area designated by an appropriate authority, within which industrial or mineral exploration and development is restricted in accordance with certain specified conditions. (S-57 Edition 3.1, Appendix A – Chapter 2, Page 2.178, November 2000).

20) Drilling prohibited

IHO Definition: An area within which excavating a hole on the seabed with a drill is prohibited. (S-57 Edition 3.1, Appendix A – Chapter 2, Page 2.178, November 2000).

21) Drilling restricted

IHO Definition: A specified area designated by an appropriate authority, within which excavating a hole on the seabed with a drill is restricted in accordance with certain specified conditions. (S-57 Edition 3.1, Appendix A – Chapter 2, Page 2.178, November 2000).

22) Removal of historical artefacts prohibited

IHO Definition: An area within which the removal of historical artefacts is prohibited. (S-57 Edition 3.1, Appendix A – Chapter 2, Page 2.178, November 2000).

23) Cargo transshipment (lightening) prohibited

IHO Definition: An area in which cargo transshipment (lightening) is prohibited. (S-57 Edition 3.1, Appendix A – Chapter 2, Page 2.178, November 2000).

24) Dragging prohibited

IHO Definition: An area in which the dragging of anything along the seabed, for example bottom trawling, is prohibited. (S-57 Edition 3.1, Appendix A – Chapter 2, Page 2.178, November 2000).

25) Stopping prohibited

IHO Definition: An area in which a vessel is prohibited from stopping. (S-57 Edition 3.1, Appendix A – Chapter 2, Page 2.178, November 2000).

26) Landing prohibited

IHO Definition: An area in which landing is prohibited. (S-57 Edition 3.1, Appendix A – Chapter 2, Page 2.179, November 2000).

27) Speed restricted

IHO Definition: An area within which speed is restricted. (S-57 Edition 3.1, Appendix A – Chapter 2, Page 2.179, November 2000).

39) Swimming prohibited

IHO Definition: An area in which swimming is prohibited.

Remarks:

- The official legal status of each kind of restricted area defines the kind of restriction(s), for example the restriction for a “game preserve” may be “entry prohibited”, the restriction for a “fish sanctuary” may be “fishing restricted”.
- The complete information about the restriction(s), actually held in handbooks or other publications, may be encoded by an associated instance of the information class **Nautical Information** (see clause X.X), complex attribute **information**, sub-attribute **file reference**. A short explanation may be given by the use of **information**, sub-attribute **text**.

27.147 Scale minimum (SCAMIN)

Scale minimum: IHO Definition: The minimum scale at which the feature may be used for example for ECDIS presentation.

Minimum value: 1

Indication: The modulus of the scale is indicated, that is 1:89 999 is encoded as 89999.

Unit: None

Resolution: 1

Format: xxxxxxxx

Example: If a particular minimum scale is specified as 1:89 999 (encoded as **89999**), and an example of a smaller scale would be 1:179 999 (encoded as **179999**).

The **scale minimum** value of a feature determines the display scale below which the feature is no longer displayed. Its purpose is to reduce clutter, to prioritise the display of features and to improve display speed. In encoding its value, the producing authority should consider these factors, as well as the scale at which the feature is no longer likely to be required for navigation.

In order to optimise the performance and clarity of the ENC, it is a mandatory requirement on ENCs that **scale minimum** is used.

Remarks:

- **scale minimum** only affects the display of a feature on an ECDIS, not its presence in the SENC.
- If **scale minimum** is not encoded, the feature is displayed at all scales.
- Where **scale minimum** is used, it must always be set to a scale less (that is, to a smaller scale) than or equal to the maximum display scale of the data as described in clause X.X. Failure to follow this rule will mean that features will not be displayed on the ECDIS until the overscale warning is activated.
- Skin of the Earth and Meta features must always be displayed. Therefore, **scale minimum** must not be encoded on Skin of the Earth and Meta features.
- If the same feature exists in datasets of different maximum display scales, the same **scale minimum** value must be assigned to each occurrence of the feature.

27.148 Sector bearing

Sector bearing: IHO Definition: A sector is the part of a circle between two straight lines drawn from the centre to the circumference. (Advanced Learner's Dictionary, 2nd Edition).

Sector bearing specifies the limit of the sector. (Adapted from S-57 Edition 3.1, Appendix A – Chapter 2, Page 2.184, November 2000).

Unit: Degree (°)

Resolution: 0.01°

Format: xxx.xx

Example: **125** for a sector bearing of 125 degrees

Remarks:

- The values given to the common limits of adjacent sectors should be identical.
- The orientation of the bearing is from seaward to the central feature. This conforms with the method used in "List of Lights" publications.
- A generic term such as "to shore" cannot be used; a specific bearing must be encoded. Where a light sector limit is defined as "to the shore", it should be encoded using a value that ensures that, when the limit is drawn, it will fall entirely on land.

27.149 Sector line length

Sector line length: IHO Definition: A sector is the part of a circle between two straight lines drawn from the centre to the circumference. (Advanced Learner's Dictionary, 2nd Edition).

Sector line length specifies the displayed length of the line, in ground units, defining the limit of the sector.

Unit: Defined as an attribute in the ENC dataset metadata: metre (m)

Resolution: 1m

Format: xxxx

Example: **3200** for a sector line length of 3200 metres

Remarks:

- Sector lines should be displayed such that they cover the area where they are useful to mariners.
- Sector lines must not extend beyond the nominal range of the light sector.

27.150 Signal duration

Signal duration: IHO Definition: The time occupied by a single instance of light/sound or eclipse/silence in a signal sequence.

Unit: Seconds (s)

Resolution: 0.01s

Format: xx.xx

Minimum value: > 0

Example: **2.5** for an duration of 2.5 seconds

Remarks:

- No remarks.

27.151 Signal frequency (SIGFRQ)

Signal frequency: IHO Definition: The frequency of a signal. (S-57 Edition 3.1, Appendix A – Chapter 2, Page 2.187, November 2000).

Unit: Hertz (Hz)

Resolution: 1 Hz

Format: xxxxxxxxxxxx

Example: **950000000** for a radio signal centred on 950 MHz

Remarks:

- No remarks.

27.152 Signal generation (SIGGEN)

Signal generation: IHO Definition: The mechanism used to generate a fog signal.

1) **Automatically**

IHO Definition: Signal generation is initiated by a self regulating mechanism such as a timer or light sensor. (S-57 Edition 3.1, Appendix A – Chapter 2, Page 2.188, November 2000).

2) **By wave action**

IHO Definition: The signal is generated by the motion of the sea surface such as a bell in a buoy. (S-57 Edition 3.1, Appendix A – Chapter 2, Page 2.188, November 2000).

3) **By hand**

IHO Definition: The signal is generated by a manually operated mechanism such as a hand cranked siren. (S-57 Edition 3.1, Appendix A – Chapter 2, Page 2.188, November 2000).

4) **By wind**

IHO Definition: The signal is generated by the motion of air such as a wind driven whistle. (S-57 Edition 3.1, Appendix A – Chapter 2, Page 2.188, November 2000).

5) **Radio activated**

IHO Definition: Activated by radio signal.

6) **Call activated**

IHO Definition: Activated by making a call to a manned station.

Remarks:

- The attribute “signal generation” encodes the mechanism used to generate a fog signal.

27.153 Signal group (SIGGRP)

Signal group: IHO Definition: The number of signals, the combination of signals or the Morse character(s) within one period of full sequence. (S-57 Edition 3.1, Appendix A – Chapter 2, Page 2.189, November 2000).

Indication: The signal group of a light is encoded using brackets to separate the individual groups. A group of signals may be a single number, a chain of numbers separated by "+", a sequence of up to 4 letters or a letter and a number.

A fixed light has no signal group.

Where no specific signal group is given for one of the light characteristics, this should be shown by an empty pair of brackets.

Format: (c)(c)...

Examples:**light characteristic signal group**

VQ(6)+LFI	->	(6)(1)
LFI+FI(2+3)	->	(1)(2+3)
FI(2)+LFI	->	(2)(1)
FFI	->	()(1)
Mo(AA)	->	(AA)
AlFI(2W+1R)	->	(2+1)
AlLFIWR	->	(1)
FOcW	->	()(1)
AlOc(4)WR	->	(4)
AlWR	->	()
Iso	->	(1)
IQ	->	()

Remarks:

- No remarks.

27.154 Signal period (SIGPER)

Signal period: IHO Definition: The time occupied by an entire cycle of intervals of light and eclipse. (S-57 Edition 3.1, Appendix A – Chapter 2, Page 2.190, November 2000).

Unit: Seconds (s)

Resolution: 0.01s

Format: xx.xx

Minimum value: > 0

Example: **12** for an interval of 12 seconds

Remarks:

- No remarks.

27.155 Signal status

Signal status: IHO Definition: The indication of an element of a signal sequence being a period of light or eclipse.

1) **Lit/sound**

IHO Definition:

2) **Eclipsed/silent**

IHO Definition:

Remarks:

- No remarks.

27.156 Speed limit

Speed limit: IHO Definition: The maximum allowed rate of travel in an area.

Unit: Knot (kt)

Resolution: 0.1kt.

Format: xx.x

Example: 4.5 for a speed limit of 4.5 knots

Remarks:

- No remarks.

27.157 Speed maximum (CURVEL)

Speed maximum: IHO Definition: Rate of motion. The terms speed and velocity are often used interchangeably, but speed is a scalar, having magnitude only, while velocity is a vector quantity, having both magnitude and direction. (Adapted from IHO Dictionary, S-32).

Speed maximum is the maximum rate of travel that can occur. (Adapted from S-57 Edition 3.1, Appendix A – Chapter 2, Page 2.121, November 2000).

Unit: Knot (kt)

Resolution: 0.1kt.

Format: xx.x

Example: 2.1 for a maximum speed of 2.1 knots

Remarks:

- No remarks.

27.158 Speed minimum

Speed minimum: IHO Definition: Rate of motion. The terms speed and velocity are often used interchangeably, but speed is a scalar, having magnitude only, while velocity is a vector quantity, having both magnitude and direction. (Adapted from IHO Dictionary, S-32).

Speed minimum is the minimum rate of travel that can occur. (Adapted from S-57 Edition 3.1, Appendix A – Chapter 2, Page 2.121, November 2000).

Unit: Knot (kt)

Resolution: 0.1kt.

Format: xx.x

Example: 1.6 for a maximum speed of 1.6 knots

Remarks:

- No remarks.

27.159 Station name

Station name: IHO Definition: The name of the reference tide station with reference water level for tidal stream panel observations.

Indication: Name of tidal stream station (c...): String of characters.

Format: c...

Example: Darwin for the Darwin tide station.

Remarks:

- No remarks.

27.160 Station number

Station number: IHO Definition: The identification number of the reference tide station with reference water

level for tidal stream panel observations.

Indication: The value indicates the reference number of a tide station as listed in national Tide Tables.

Example: **63230** for the reference number of Darwin tide station.

Remarks:

- No remarks.

27.161 Status (STATUS)

Status: IHO Definition: **Definition required.**

1) **Permanent**

IHO Definition: Intended to last or function indefinitely. (The Concise Oxford Dictionary, 7th Edition).

2) **Occasional**

IHO Definition: Acting on special occasions; happening irregularly. (The Concise Oxford Dictionary, 7th Edition).

3) **Recommended**

IHO Definition: Presented as worthy of confidence, acceptance, use, etc. (The Macquarie Dictionary, 1988).

4) **Not in use**

IHO Definition: Use has ceased, but the facility still exists intact; disused. (Adapted from Defence Geospatial Information Working Group; Feature Data Dictionary Register, 2010).

5) **Periodic/intermittent**

IHO Definition: Recurring at intervals. (The Concise Oxford Dictionary, 7th Edition).

6) **Reserved**

IHO Definition: Set apart for some specific use. (Adapted from The Concise Oxford Dictionary, 7th Edition).

7) **Temporary**

IHO Definition: Meant to last only for a time. (The Concise Oxford Dictionary).

8) **Private**

IHO Definition: Administered by an individual or corporation, rather than a State or a public body. (Defence Geospatial Information Working Group; Feature Data Dictionary Register, 2010).

9) **Mandatory**

IHO Definition: Compulsory; enforced. (The Concise Oxford Dictionary, 7th Edition).

11) **Extinguished**

IHO Definition: No longer lit. (S-57 Edition 3.1, Appendix A – Chapter 2, Page 2.197, November 2000).

12) **Illuminated**

IHO Definition: Lit by floodlights, strip lights, etc. (S-57 Edition 3.1, Appendix A – Chapter 2, Page 2.198, November 2000).

13) **Historic**

IHO Definition: Famous in history; of historical interest. (The Concise Oxford Dictionary, 7th Edition).

14) **Public**

IHO Definition: Belonging to, available to, used or shared by, the community as a whole and not restricted to private use. (Adapted from The New Shorter Oxford English Dictionary, 1993).

15) Synchronised

IHO Definition: Occur at a time, coincide in point of time, be contemporary or simultaneous. (The New Shorter Oxford English Dictionary, 1993).

16) Watched

IHO Definition: Looked at or observed over a period of time especially so as to be aware of any movement or change. (adapted from The New Shorter Oxford English Dictionary, 1993).

17) Un-watched

IHO Definition: Usually automatic in operation, without any permanently-stationed personnel to superintend it. (Adapted from IHO Dictionary – S-32).

18) Existence doubtful

IHO Definition: A feature that has been reported but has not been definitely determined to exist. (Adapted from S-57 Edition 3.1, Appendix A – Chapter 2, Page 2.198, November 2000).

28) Buoyed

IHO Definition: Marked by buoys. (Australian Hydrographic Service).

Remarks:

- No remarks.

27.162 Stream depth

Stream depth: IHO Definition: The depth below the sea surface to which the tidal stream data refers relative to the sounding datum.

Unit: Defined as an attribute in the ENC dataset metadata: metre (m)

Resolution: 0.1m

Format: xxxxx.x

Examples: **0** for surface tidal stream data
15 for tidal stream data collected at a depth of 15 metres

Remarks:

- No remarks.

27.163 Swept date

Swept date: IHO Definition: **Definition required.**

Indication: The **swept date** should be encoded using 4 digits for the calendar year (YYYY), 2 digits for the month (MM) (for example April = 04) and 2 digits for the day (DD). When no specific month and/or day is required/known, indication of the month and/or day is omitted, and replaced with dashes (-).

This conforms to ISO 8601:2004.

Format: YYYYMMDD (full date, **mandatory**)
YYYYMM-- (no specific day required – **mandatory**)
YYYY---- (no specific month required – **mandatory**)

Example: **20101203** for 03 December 2010 as the swept date.

Remarks:

- No remarks.

27.164 Technique of vertical measurement (TECSOU)

Technique of vertical measurement: IHO Definition: Definition required.

1) **Found by echo-sounder**

IHO Definition: The depth was measured by using an instrument that determines depth of water by measuring the time interval between emission of a sonic or ultrasonic signal and return of its echo from the seabed. (Adapted from IHO Dictionary – S-32).

2) **Found by side scan sonar**

IHO Definition: The depth was computed from a record produced by active sonar in which fixed acoustic beams are directed into the water perpendicularly to the direction of travel to scan the seabed and generate a record of the seabed configuration. (Adapted from IHO Dictionary – S-32).

3) **Found by multi-beam**

IHO Definition: The depth was measured by using a wide swath echo sounder that uses multiple beams to measure depths directly below and transverse to the ship's track. (Adapted from IHO Dictionary – S-32).

4) **Found by diver**

IHO Definition: The depth was measured by a person skilled in the practice of diving. (Adapted from IHO Dictionary – S-32).

5) **Found by lead-line**

IHO Definition: The depth was measured by using a line, graduated with attached marks and fastened to a sounding lead. (Adapted from IHO Dictionary – S-32).

6) **Swept by wire-drag**

IHO Definition: The given area was determined to be free from navigational dangers to a certain depth by towing a buoyed wire at the desired depth by two launches, or a least depth was identified using the same technique. (Adapted from IHO Dictionary – S-32).

7) **Found by laser**

IHO Definition: The elevation was measured by using an instrument that measures distance by emitting timed pulses of laser light and measuring the time between emission and reception of the reflected pulses. (Adapted from IHO Dictionary – S-32).

8) **Swept by vertical acoustic system**

IHO Definition: The given area has been swept using a system comprised of multiple echo sounder transducers attached to booms deployed from the survey vessel. (S-57 Edition 3.1, Appendix A – Chapter 2, Page 2.207, November 2000).

9) **Found by electromagnetic sensor**

IHO Definition: The depth was measured by using an instrument that compares electromagnetic signals. (Adapted from IHO Dictionary – S-32).

10) **Photogrammetry**

IHO Definition: The depth was determined by applying mathematical techniques to photographs. (Adapted from IHO Dictionary – S-32).

11) **Satellite imagery**

IHO Definition: The depth was determined by using instruments placed aboard an artificial satellite. (Adapted from IHO Dictionary – S-32).

12) **Found by levelling**

IHO Definition: The depth was measured by using levelling techniques to find the elevation of the point relative to a datum. (Adapted from IHO Dictionary – S-32).

13) **Swept by side-scan sonar**

IHO Definition: The given area was determined to be free from navigational dangers to a certain depth by towing a side-scan-sonar. (Adapted from IHO Dictionary – S-32).

15) Found by LIDAR

IHO Definition: The depth was measured by using an instrument that measures distance by emitting timed pulses of laser light and measuring the time between emission and reception of the reflected pulses. (Adapted from IHO Dictionary – S-32).

Remarks:

- No remarks.

27.165 Telecommunication identifier

Telecommunication identifier: **IHO Definition:** An identifier, such as words, numbers, letters, symbols, or any combination of those used to establish a contact to a particular person, organisation or service.

Indication:

Format: c...

Example: +61 2 4223 6500; pilsener@beer.com

Remarks:

- The telecommunication identifier should include the international and any applicable regional codes.

27.166 Telecommunication service

Telecommunication service: **IHO Definition:** Methods to communicate between involved parties over a distance.

Indication: The attribute describes the access to online resources according to ISO 19115.

Format: **Codelist Type** open enumeration see clause X.X

Expected input:

1) Voice

IHO Definition: The transfer or exchange of information by using sounds that are being made by mouth and throat when speaking.

2) Facsimile

IHO Definition: A system of transmitting and reproducing graphic matter (as printing or still pictures) by means of signals sent over telephone lines. (Merriam-Webster Dictionary – 2014).

3) SMS

IHO Definition: Short Message Service – a form of text messaging communication on phones and mobile phones.

4) Data

IHO Definition: Facts or information used usually to calculate, analyse, or plan something. (Merriam-Webster Dictionary – 2014).

5) Streamed data

IHO Definition: Data that is constantly received by and presented to an end-user while being delivered by a provider.

6) Telex

IHO Definition: A system of communication in which messages are sent over long distances by using a telephone system and are printed by using a special machine (called a teletypewriter). (Merriam-Webster Dictionary – 2014).

7) Telegraph

IHO Definition: An apparatus, system or process for communication at a distance by electric transmission over wire.

8) Email

IHO Definition: Messages and other data exchanged between individuals using computers in a network. (Merriam-Webster Dictionary – 2014).

OTHER [something]

Remarks:

- No remarks.

27.167 Text (INFORM, NINFOM)

Text: IHO Definition: A non-formatted digital text string.

Remarks:

- This attribute should be used, for example, to hold the information that is shown on paper charts by short cautionary or explanatory notes. Therefore, text populated in **text** must not exceed 300 characters.
- Text may be in English, or in a national language defined by the attribute **language** (see clause X.X).
- No formatting of text is possible within **text**. If formatted text, or text strings exceeding 300 characters, is required, then the sub-attribute **file reference** must be used (see clause X.X).

27.168 Text justification

Text justification: IHO Definition: The anchor point of a text string.

1) Left

IHO Definition: The anchor point is at the start of the text string.

2) Centred

IHO Definition: The anchor point is at the centre of the text string.

3) Right

IHO Definition: The anchor point is at the end of the text string.

Remarks:

- No remarks.

27.169 Text type

Text type: IHO Definition: The attribute from which a text string is derived.

- 1) **Feature name** (see clause X.X)
- 2) **Light characteristic** (see clause X.X)

Remarks:

- No remarks.

27.170 Time of day end

Time of day end: IHO Definition: Definition required.

Indication: The “time of day end” must be encoded using 2 digits for the hour (hh), 2 digits for the minutes (mm) and 2 digits for the seconds (ss). This conforms to ISO 8601:2004.

Format: hhmmss (**mandatory**)

Example: **162000** for a period ending at 04:20 pm.

Remarks:

- The attribute “time of day end” indicates the end of an active period.

27.171 Time of day start

Time of day start: IHO Definition: **Definition required.**

Indication: The “time of day start” must be encoded using 2 digits for the hour (hh), 2 digits for the minutes (mm) and 2 digits for the seconds (ss). This conforms to ISO 8601:2004.

Format: hhmmss (**mandatory**)

Example: **094500** for a period starting at 09:45 am.

Remarks:

- The attribute “time of day start” indicates the end of an active period.

27.172 Time reference

Time reference: IHO Definition: Definition required.

- 1) **Local time**
- 2) **Coordinated Universal Time (UTC)**

Remarks:

- No remarks.

27.173 Time relative to tide

Time relative to tide: IHO Definition: The time difference relative to the reference tide.

Unit: Hour

Resolution: 0.1 hour

Format: sxx.x

s: sign, negative values only

Example: **1.5** for 1.5 hours after the referenced tide

Remarks:

- Positive values are time after the referenced tide, negative values are time before the referenced tide.

27.174 Topmark/daymark shape (TOPSHP)

Topmark/daymark shape: IHO Definition: **Definition required.**

Cone: A solid figure generated by straight lines drawn from a fixed point (the vertex) to a circle in a plane not containing the vertex. (The New Shorter Oxford English Dictionary, 1993, vol 2).

Cones are commonly used as International Association of Lighthouse Authorities - IALA topmarks (lateral). (S-57 Edition 3.1, Appendix A – Chapter 2, Page 2.222, November 2000).

1) Cone, point up

IHO Definition: Is where the vertex points up. (S-57 Edition 3.1, Appendix A – Chapter 2, Page 2.222, November 2000).

2) Cone, point down

IHO Definition: Is where the vertex points down. (S-57 Edition 3.1, Appendix A – Chapter 2, Page 2.222, November 2000).

3) Sphere

IHO Definition: A body the surface of which is at all points equidistant from the centre. (The New Shorter Oxford English Dictionary, 1993, vol 2).

Spheres are commonly used as International Association of Lighthouse Authorities - IALA topmarks (safe water). (S-57 Edition 3.1, Appendix A – Chapter 2, Page 2.223, November 2000).

4) 2 spheres

IHO Definition: Two black spheres, one above the other. Two spheres are commonly used as an International Association of Lighthouse Authorities - IALA topmark (isolated danger). (S-57 Edition 3.1, Appendix A – Chapter 2, Page 2.223, November 2000).

5) Cylinder (can)

IHO Definition: A solid geometrical figure generated by straight lines fixed in direction and describing with one of point a closed curve, especially a circle (in which case the figure is circular cylinder, its ends being parallel circles). (The New Shorter Oxford English Dictionary, 1993, vol 2).

Cylinders are commonly used as International Association of Lighthouse Authorities - IALA topmarks (lateral). (S-57 Edition 3.1, Appendix A – Chapter 2, Page 2.223, November 2000).

6) Board

IHO Definition: Usually of rectangular shape, made from timber or metal and used to provide a contrast with the natural background of a daymark. The actual daymark is often painted on to this board. (S-57 Edition 3.1, Appendix A – Chapter 2, Page 2.223, November 2000).

7) X-shaped (St. Andrew's cross)

IHO Definition: Having a shape or a cross-section like the capital letter X. (The New Shorter Oxford English Dictionary, 1993, vol 2).

An x-shape as an International Association of Lighthouse Authorities – IALA topmark should be 3 dimensional in shape. It is made of at least three crossed bars. (S-57 Edition 3.1, Appendix A – Chapter 2, Page 2.223, November 2000).

8) Upright cross (St George's cross)

IHO Definition: A cross with one vertical member and one horizontal member; that is, similar in shape to the character "+". (S-57 Edition 3.1, Appendix A – Chapter 2, Page 2.223, November 2000).

9) Cube, point up

IHO Definition: A cube is a solid contained by six equal squares; a regular hexahedron (The New Shorter Oxford English Dictionary, 1993, vol 2).

A cube, point up, is a cube standing on one of its vertexes.

10) 2 cones, point to point

IHO Definition: 2 cones, one above the other, with their vertices together in the centre. (S-57 Edition 3.1, Appendix A – Chapter 2, Page 2.223, November 2000).

11) 2 cones, base to base

IHO Definition: 2 cones, one above the other, with their bases together in the centre and their vertices pointing up and down. (S-57 Edition 3.1, Appendix A – Chapter 2, Page 2.223, November 2000).

12) Rhombus (diamond)

IHO Definition: A plane figure having four equal sides and equal opposite angles (two acute and two

obtuse); an oblique equilateral parallelogram. (The New Shorter Oxford English Dictionary, 1993, vol 2).

13) 2 cones (points upward)

IHO Definition: 2 cones, one above the other, with their vertices pointing up.

14) 2 cones (points downward)

IHO Definition: 2 cones, one above the other, with their vertices pointing down.

15) Besom, point up (broom or perch)

IHO Definition: A bundle of rods or twigs. (The New Shorter Oxford English Dictionary, 1993, vol 2). A perch is a staff placed on top of a buoy, rock or shoal as a mark for navigation. (IHO Dictionary – S-32).

A besom, point up is where the thicker (untied) end of the besom is at the bottom.

16) Besom, point down (broom or perch)

IHO Definition: A bundle of rods or twigs. (The New Shorter Oxford English Dictionary, 1993, vol 2). A perch is a staff placed on top of a buoy, rock or shoal as a mark for navigation. (IHO Dictionary – S-32).

A besom, point down is where the thinner (tied) end of the besom is at the **bottom**.

17) Flag

IHO Definition: A flag mounted on a short pole. (S-57 Edition 3.1, Appendix A – Chapter 2, Page 2.223, November 2000).

18) Sphere over rhombus

IHO Definition: A sphere located above a rhombus. (S-57 Edition 3.1, Appendix A – Chapter 2, Page 2.223, November 2000).

19) Square

IHO Definition: A plane figure with four right angles and four equal straight sides (The New Shorter Oxford English Dictionary, 1993, vol 2).

20) Rectangle, horizontal

IHO Definition: A rectangle is a plane figure with four right angles and four straight sides, opposite sides being parallel and equal in length (The New Shorter Oxford English Dictionary, 1993, vol 2).

A horizontal rectangle is where the two longer opposite sides are standing horizontally.

21) Rectangle, vertical

IHO Definition: A rectangle is a plane figure with four right angles and four straight sides, opposite sides being parallel and equal in length (The New Shorter Oxford English Dictionary, 1993, vol 2).

A vertical rectangle is where the two longer opposite sides are standing vertically.

22) Trapezium, up

IHO Definition: A trapezium is a quadrilateral having one pair of opposite sides parallel. (The New Shorter Oxford English Dictionary, 1993, vol 2).

A trapezium, up is a trapezium which stands on its longer parallel side. (S-57 Edition 3.1, Appendix A – Chapter 2, Page 2.224, November 2000).

23) Trapezium, down

IHO Definition: A trapezium is a quadrilateral having one pair of opposite sides parallel. (The New Shorter Oxford English Dictionary, 1993, vol 2).

A trapezium, down is a trapezium which stands on its shorter parallel side. (S-57 Edition 3.1, Appendix A – Chapter 2, Page 2.224, November 2000).

24) Triangle, point up

IHO Definition: A triangle is a figure having three angles and three sides. (New Shorter Oxford English Dictionary, 1993, vol 2).

A triangle, point up is a triangle which has a vertex at the top.

25) **Triangle, point down**

IHO Definition: A triangle is a figure having three angles and three sides. (New Shorter Oxford English Dictionary, 1993, vol 2).

A triangle, point down is a triangle which has a side at the top.

26) **Circle**

IHO Definition: A perfectly round plane figure whose circumference is everywhere equidistant from its centre. (The New Shorter Oxford English Dictionary, 1993, vol 1).

27) **Two upright crosses (one over the other)**

IHO Definition: Two upright crosses, generally vertically disposed one above the other. (S-57 Edition 3.1, Appendix A – Chapter 2, Page 2.224, November 2000).

28) **T-shape**

IHO Definition: Having a shape like the capital letter T. (S-57 Edition 3.1, Appendix A – Chapter 2, Page 2.224, November 2000).

29) **Triangle pointing up over a circle**

IHO Definition: A triangle, vertex uppermost, located above a circle. (S-57 Edition 3.1, Appendix A – Chapter 2, Page 2.224, November 2000).

30) **Upright cross over a circle**

IHO Definition: An upright cross located above a circle. (S-57 Edition 3.1, Appendix A – Chapter 2, Page 2.224, November 2000).

31) **Rhombus over circle**

IHO Definition: A rhombus located above a circle. (S-57 Edition 3.1, Appendix A – Chapter 2, Page 2.224, November 2000).

32) **Circle over a triangle pointing up**

IHO Definition: A circle located over a triangle, vertex uppermost. (S-57 Edition 3.1, Appendix A – Chapter 2, Page 2.224, November 2000).

33) **Other shape (see shape information)**

IHO Definition: Definition required.

Remarks:

- No remarks.

27.175 Traffic flow (TRAFIC)

Traffic flow: IHO Definition: Definition required.

1) **Inbound**

IHO Definition: Traffic flow in a general direction toward a port or similar destination. (S-57 Edition 3.1, Appendix A – Chapter 2, Page 2.225, November 2000).

2) **Outbound**

IHO Definition: Traffic flow in a general direction away from a port or similar point of origin. (S-57 Edition 3.1, Appendix A – Chapter 2, Page 2.225, November 2000).

3) **One-way**

IHO Definition: Traffic flow in one general direction only. (S-57 Edition 3.1, Appendix A – Chapter 2, Page 2.225, November 2000).

4) Two-way

IHO Definition: Traffic flow in two generally opposite directions. (S-57 Edition 3.1, Appendix A – Chapter 2, Page 2.225, November 2000).

Remarks:

- No remarks.

27.176 Underlying layer

Underlying layer: **IHO Definition:** The position of the seabed type within the layers of the seabed.

Indication: The value indicates the level of a material in a layered seabed, with the value 0 indicating the topmost level.

Example: 1 where the seabed type is the layer below the top of the seabed surface.

Remarks:

- No remarks.

27.177 Value of annual change in magnetic variation (VALACM)

Value of annual change in magnetic variation: **IHO Definition:** The annual change in magnetic variation values. (S-57 Edition 3.1, Appendix A – Chapter 2, Page 2.226, November 2000).

Unit: minute (′), negative west

Resolution: 0.1′

Format: sxx.x
s: sign, negative values only

Example: -7.1 for an annual change of 7.1′ in a westerly direction

Remarks:

- A positive value; that is, unsigned, indicates a change in an easterly direction and a negative value indicates a change in a westerly direction.

27.178 Value of depth contour (VALDCO)

Value of depth contour: **IHO Definition:** The depth of a seabed contour. (S-57 Edition 3.1, Appendix A – Chapter 2, Page 2.227, November 2000).

Unit: metre (m)

Resolution: 0.1m

Format: sxxxxx.x
s: sign, negative values only

Example: 50 for a depth contour of 50 metres

Remarks:

- Drying contours are indicated by a negative value.

27.179 Value of magnetic variation (VALMAG)

Value of magnetic variation: **IHO Definition:** The magnetic variation value. (S-57 Edition 3.1, Appendix A – Chapter 2, Page 2.229, November 2000).

Unit: degree (°), negative west

Resolution: 0.01°

Format: sxx.xx

s: sign, negative values only

Example: **2.3** for a magnetic north oriented at 2.3 degrees (2°18') east from the geographic (true) north

Remarks:

- A positive value; that is, unsigned, indicates a change in an easterly direction and a negative value indicates a change in a westerly direction.

27.180 Value of maximum range (VALMXR)

Value of maximum range: IHO Definition: The extreme distance at which a feature can be seen or a signal detected. (Adapted from S-57 Edition 3.1, Appendix A – Chapter 2, Page 2.230, November 2000).

Unit: Nautical mile (M)

Resolution: 0.1M

Format: xx.x

Example: **17** for maximum range of 17 nautical miles

Remarks:

- This attribute does not apply to lights, where the attribute “value of nominal range” should be used.

27.181 Value of nominal range (VALNMR)

Value of nominal range: IHO Definition: The nominal range at which a feature can be seen or a signal detected. (S-57 Edition 3.1, Appendix A – Chapter 2, Page 2.231, November 2000).

Unit: Nautical mile (M)

Resolution: 0.1M

Format: xx.x

Example: **14** for a nominal range of 14 nautical miles

Remarks:

- The nominal range is normally the luminous range of a light in a homogeneous atmosphere in which the meteorological visibility is 10 sea miles. (IHO Dictionary – S-32).

27.182 Value of sounding (VALSOU)

Value of sounding: IHO Definition: The value of the measurement of a sounding relative to the chart datum. (S-57 Edition 3.1, Appendix A – Chapter 2, Page 2.232, November 2000).

Unit: Defined as an attribute in the ENC dataset metadata: metre (m)

Resolution: 0.1m

Format: sxxxxx.x

s: sign, negative values only

Examples: **18.2** for a sounding of 18.2 metres

-2.4 for a drying height of 2.4 metres

Remarks:

- A drying height is indicated by a negative value.

27.183 Vertical clearance value (VERCLR)

Vertical clearance value: IHO Definition: The vertical clearance measured from the horizontal plane towards the feature overhead. (S-57 Edition 3.1, Appendix A – Chapter 2, Page 2.234, November 2000).

Unit: Defined as an attribute in the ENC dataset metadata: metre (m)

Resolution: 0.1m

Format: xx.x

Example: 7.6 for a vertical clearance of 7.6 metres

Remarks:

- No remarks.

27.184 Vertical datum (VERDAT)

Vertical datum: IHO Definition: Definition required.

1) Mean low water springs

IHO Definition: (MLWS) - the average height of the low waters of spring tides. Also called spring low water. (IHO Dictionary – S-32).

2) Mean lower low water springs

IHO Definition: (MLLWS) - the average height of lower low water springs at a place. (IHO Dictionary – S-32).

3) Mean sea level

IHO Definition: (MSL) - the average height of the surface of the sea at a tide station for all stages of the tide over a 19-year period, usually determined from hourly height readings measured from a fixed predetermined reference level. (IHO Dictionary – S-32).

4) Lowest low water

IHO Definition: An arbitrary level conforming to the lowest tide observed at a place, or somewhat lower. (S-57 Edition 3.1, Appendix A – Chapter 2, Page 2.239, November 2000).

5) Mean low water

IHO Definition: (MLW) - the average height of all low waters at a place over a 19-year period. (IHO Dictionary – S-32).

6) Lowest low water springs

IHO Definition: An arbitrary level conforming to the lowest water level observed at a place at spring tides during a period of time shorter than 19 years. (Hydrographic Service, Royal Australian Navy).

7) Approximate mean low water springs

IHO Definition: An arbitrary level, usually within $\pm 0.3\text{m}$ from that of mean low water springs (MLWS). (Hydrographic Service, Royal Australian Navy).

8) Indian spring low water

IHO Definition: (ISLW) - an arbitrary tidal datum approximating the level of the mean of the lower low water at spring tides. Also called Indian tidal plane. (IHO Dictionary – S-32).

A tidal datum approximating the lowest water level observed at a place, originated by G.H. Darwin for the tides of India at a level below MSL being equal to the sum of amplitudes of the harmonic constituents M2, S2, K1 and O1; usually below that of the lower low water at spring tides. Also called Indian tide plane. (Hydrographic Service, Royal Australian Navy).

9) Low water springs

IHO Definition: An arbitrary level, approximating that of mean low water springs (MLWS). (Hydrographic

Service, Royal Australian Navy).

10) Approximate lowest astronomical tide

IHO Definition: An arbitrary level, usually within $\pm 0.3\text{m}$ from that of lowest astronomical tide (LAT). (Hydrographic Service, Royal Australian Navy).

11) Nearly lowest low water

IHO Definition: An arbitrary level approximating the lowest water level observed at a place, usually equivalent to the Indian spring low water (ISLW). (Hydrographic Service, Royal Australian Navy).

12) Mean lower low water

IHO Definition: (MLLW) - the average height of the lower low waters at a place over a 19-year period. (IHO Dictionary – S-32).

13) Low water

IHO Definition: An approximation of mean low water adopted as the reference level for a limited area, irrespective of better determinations at a later date. Used mostly in harbour and river engineering. (S-57 Edition 3.1, Appendix A – Chapter 2, Page 2.239, November 2000).

Used in inland (non-tidal) waters. It is generally defined as a level which the daily mean water level would fall below less than 5% of the time and by no more than 0.2 metres during the navigation season. A single level surface is usually chosen as the low water datum for a whole lake. On a river, low water datum is a sloping surface which approximates the river surface at a low state. (Canadian Hydrographic Service)

14) Approximate mean low water

IHO Definition: An arbitrary level, usually within $\pm 0.3\text{m}$ from that of mean low water (MLW). (Hydrographic Service, Royal Australian Navy).

15) Approximate mean lower low water

IHO Definition: An arbitrary level, usually within $\pm 0.3\text{m}$ from that of mean lower low water (MLLW). (Hydrographic Service, Royal Australian Navy).

16) Mean high water

IHO Definition: (MHW) - The average height of all high waters at a place over a 19-year period. (IHO Dictionary, S-32).

17) Mean high water springs

IHO Definition: (MHWS) - The average height of the high waters of spring tides. Also called spring high water. (IHO Dictionary, S-32).

18) High water

IHO Definition: The highest level reached at a place by the water surface in one tidal cycle. Also called high tide. (IHO Dictionary, S-32).

19) Approximate mean sea level

IHO Definition: An arbitrary level, usually within $\pm 0.3\text{m}$ from that of mean sea level (MSL). (Hydrographic Service, Royal Australian Navy).

20) High water springs

IHO Definition: An arbitrary level, approximating that of mean high water springs (MHWS). (Hydrographic Service, Royal Australian Navy).

21) Mean higher high water

IHO Definition: (MHHW) - The average height of higher high waters at a place over a 19-year period. (IHO Dictionary, S-32).

22) Equinoctial spring low water

IHO Definition: The level of low water springs near the time of an equinox. (S-57 Edition 3.1, Appendix A – Chapter 2, Page 2.240, November 2000).

23) Lowest astronomical tide

IHO Definition: (LAT) - the lowest tide level which can be predicted to occur under average meteorological conditions and under any combination of astronomical conditions. (IHO Dictionary – S-32).

24) Local datum

IHO Definition: An arbitrary datum defined by a local harbour authority, from which levels and tidal heights are measured by this authority. (S-57 Edition 3.1, Appendix A – Chapter 2, Page 2.240, November 2000).

25) International Great Lakes Datum 1985

IHO Definition: (IGLD 1985) - A vertical reference system with its zero based on the mean water level at Rimouski/Pointe-au-Père, Quebec, over the period 1970 to 1988. (S-57 Edition 3.1, Appendix A – Chapter 2, Page 2.240, November 2000).

26) Mean water level

IHO Definition: The average of all hourly water levels over the available period of record. (S-57 Edition 3.1, Appendix A – Chapter 2, Page 2.240, November 2000).

27) Lower low water large tide

IHO Definition: (LLWLT) - The average of the lowest low waters, one from each of 19 years of observations. (S-57 Edition 3.1, Appendix A – Chapter 2, Page 2.240, November 2000).

28) Higher high water large tide

IHO Definition: (HHWLT) - The average of the highest high waters, one from each of 19 years of observations. (S-57 Edition 3.1, Appendix A – Chapter 2, Page 2.240, November 2000).

29) Nearly highest high water

IHO Definition: An arbitrary level approximating the highest water level observed at a place, usually equivalent to the high water springs. (S-57 Edition 3.1, Appendix A – Chapter 2, Page 2.240, November 2000).

30) Highest astronomical tide

IHO Definition: (HAT) - the highest tidal level which can be predicted to occur under average meteorological conditions and under any combination of astronomical conditions. (IHO Dictionary, S-32).

Remarks:

- This attribute is used to specify the datum to which both heights (vertical datum) and soundings (sounding datum) are referred.
- When the vertical datum is unknown, such as water areas above locks, the value “local datum” should be used, and further details may be encoded using an associated instance of the information class **Nautical Information** (see clause X.X), complex attribute **information**.
- The $\pm 0.3\text{m}$ approximation quoted in the “approximate” levels is somehow arbitrary and follows the British example of their definition for “approximate LAT”.

27.185 Vertical length (VERLEN)

Vertical length: IHO Definition: The total vertical length of a feature. (S-57 Edition 3.1, Appendix A – Chapter 2, Page 2.242, November 2000).

Unit: Defined as an attribute in the ENC dataset metadata: metre (m)

Resolution: 0.1m

Format: xxx.x

Minimum value: 0

Example: **24.5** for a vertical length of 24.5 metres

Remarks:

- For floating features: The vertical distance from the surface of water to the highest point of that feature.

- For fixed features: The vertical distance from seabed or ground to the highest point of that feature.
- For features on top of other features: the vertical distance from the lowest to the highest point of that feature.
- Vertical length measurements do not require a datum.

27.186 Vessel class

Vessel class: IHO Definition: Definition required.

Indication: The string encodes the classification of a vessel, normally by length or gross tonnage.

Remarks:

- No remarks .

27.187 Virtual AIS aid to navigation type

Virtual AIS aid to navigation type: IHO Definition: A purpose of a virtual AIS Aid to navigation.

1) **North cardinal**

IHO Definition: IALA definition.

2) **East cardinal**

IHO Definition: IALA definition.

3) **South cardinal**

IHO Definition: IALA definition.

4) **West cardinal**

IHO Definition: IALA definition.

5) **Port lateral**

IHO Definition: IALA definition.

6) **Starboard lateral**

IHO Definition: IALA definition.

7) **Preferred channel to port**

IHO Definition: IALA definition.

8) **Preferred channel to starboard**

IHO Definition: IALA definition.

9) **Isolated danger**

IHO Definition: IALA definition.

10) **Safe water**

IHO Definition: IALA definition.

11) **Special purpose**

IHO Definition: IALA definition.

12) **Emergency wreck marking**

IHO Definition: IALA definition.

Remarks:

- No remarks.

27.188 Visually conspicuous (CONVIS)

Visually conspicuous: IHO Definition: Term applied to a feature either natural or artificial which is distinctly and notably visible from seaward. (IHO Dictionary – S-32).

1) Visually conspicuous

IHO Definition: Term applied to an object either natural or artificial which is distinctly and notably visible from seaward. (IHO Dictionary – S-32).

2) Not visually conspicuous

IHO Definition: An object that may be visible from seaward, but cannot be used as a fixing mark and is not conspicuous.

3) Prominent

IHO Definition: An object which is visible from seaward and may be used as a fixing mark, but is not conspicuous. (Adapted from IHO Dictionary – S-32).

Remarks:

- No remarks.

27.189 Water level effect (WATLEV)

Water level effect: IHO Definition: Definition required.

1) Partly submerged at high water

IHO Definition: Partially covered and partially dry at high water. (S-57 Edition 3.1, Appendix A – Chapter 2, Page 2.243, November 2000).

2) Always dry

IHO Definition: Not covered at high water under average meteorological conditions. (S-57 Edition 3.1, Appendix A – Chapter 2, Page 2.243, November 2000).

3) Always under water / submerged

IHO Definition: Remains covered by water at all times under average meteorological conditions. (S-57 Edition 3.1, Appendix A – Chapter 2, Page 2.243, November 2000).

4) Covers and uncovers

IHO Definition: Expression intended to indicate an area of a reef or other projection from the bottom of a body of water which periodically extends above and is submerged below the surface. Also referred to as dries or uncovers. (IHO Dictionary – S-32).

5) Awash

IHO Definition: Flush with, or washed by the waves at low water under average meteorological conditions. (Adapted from IHO Dictionary – S-32).

6) Subject to inundation or flooding

IHO Definition: An area periodically covered by flood water, excluding tidal waters. (Defence Geospatial Information Working Group; Feature Data Dictionary Register, 2010).

7) Floating

IHO Definition: Resting or moving on the surface of a liquid without sinking (Concise Oxford Dictionary).

Remarks:

- The attribute “water level effect” encodes the effect of the surrounding water on a feature.

27.190 Waterway distance

Waterway distance: IHO Definition: The length of the space between two points along a waterway. (Adapted from Oxford English Dictionary).

Unit: Defined by the sub-attribute **distance unit of measurement** (see clause X.X).

Resolution: 0.1

Format: xx.x

Example: **2.5** for a waterway distance value of 2.5 nautical miles (where **distance unit of measurement** is populated as 5 (nautical mile)).

Remarks:

- No remarks.

27.191 Wave length value

Wave length value: IHO Definition: The distance between two successive peaks (or other points of identical phase) on an electromagnetic wave. (Adapted from S-57 Edition 3.1, Appendix A – Chapter 2, Page 2.172, November 2000).

Indication:

Unit: Metre (m)

Resolution: 0.01m

Format: x.xx

Example: **0.03** for a radar transponder beacon in the wave length “3cm (X) – Band”.

Remarks:

- Radar transponder beacons generally work on the 3cm (X) – Band or the 10cm (S) – Band wave lengths. Nevertheless, wave lengths outside the marine band are used.

28 Meta Feature and Spatial Attribute and Enumerate Descriptions

28.1 Category of temporal variation

Category of coverage: IHO Definition: An assessment of the likelihood of change within an area since last survey.

1) **Extreme event**

IHO Definition: No new hydrographic survey conducted after an event (for example hurricane, earthquake, volcanic eruption, landslide, etc), which is considered likely to have changed the seafloor significantly.

2) **Likely to change**

IHO Definition: Continuous or frequent change (for example river siltation, sand waves, seasonal storms, ice bergs, etc).

3) **Likely to change but significant shoaling not expected**

IHO Definition: **Definition required.**

4) **Unlikely to change**

IHO Definition: Significant change to the seafloor is not expected.

5) **Unassessed**

IHO Definition: Temporal variation not assessed or cannot be determined.

Remarks:

- No remarks.

28.2 Data assessment

Data assessment: IHO Definition: The categorisation of the assessment level of bathymetric data for an area.

1) **Assessed**

IHO Definition: The quality of the bathymetric data has been assessed.

2) **Oceanic**

IHO Definition: The quality of oceanic bathymetric data has been assessed or is not required.

3) **Unassessed**

IHO Definition: The quality of the bathymetric data has yet to be assessed.

Remarks:

- No remarks.

28.3 Full seafloor coverage achieved

Full seafloor coverage achieved: IHO Definition: Expression stating if full seafloor coverage has been achieved in the area covered by hydrographic surveys.

Indication: Boolean. A True value is an indication that full seafloor coverage for an area covered by hydrographic survey(s) has been achieved.

Remarks:

- **full seafloor coverage achieved** applies to both the spatial completeness of feature detection and to the spatial completeness of the measurement of the regular seafloor. The former is further specified by the complex attribute **features detected**, the latter by the attributes **depth range maximum value** and **depth range minimum value**.

28.4 Horizontal distance uncertainty (HORACC)

Horizontal distance uncertainty: IHO Definition: The best estimate of the horizontal accuracy of horizontal clearances and distances. (S-57 Edition 3.1, Appendix A – Chapter 2, Page 2.136, November 2000).

Unit: Defined as an attribute in the ENC dataset metadata: metre (m)

Resolution: 0.1m

Format: xx.x

Example: **0.5** for an error of 0.5 metres.

Remarks:

- The expected input is the radius of the two-dimensional error.
- The error is assumed to be positive and negative. The plus/minus character must not be encoded.

28.5 Horizontal position uncertainty (POSACC)

Horizontal position uncertainty: IHO Definition: The best estimate of the accuracy of a position. (S-57 Edition 3.1, Appendix A – Chapter 2, Page 2.255, November 2000).

Unit: Defined in the PUNI subfield of the CRSH record: metre (m)

Resolution: 0.1m

Format: xxxx.x

Example: **25** for an error of 25 metres

Remarks:

- No remarks.

28.6 Least depth of detected features measured

Least depth of detected features measured: IHO Definition: Expression stating if the least depth of detected features in an area was measured.

Indication: Boolean. A True value is an indication that the characteristics of a hydrographic survey are such that the least depth of significant seafloor features can be determined.

Remarks:

- A feature in this context is any object, whether manmade or not, projecting above the sea floor, which may be a danger for surface navigation (reference: IHO publication S-44).
- **least depth of detected features measured** does not describe the least depth of features that were actually detected during a hydrographic survey, but the ability of the survey to detect the least depth of features with a maximum uncertainty as defined in IHO publication S-44.

28.7 Line spacing maximum (SDISMX)

Line spacing maximum: IHO Definition: The maximum distance between hydrographic survey lines.

Unit: metre

Resolution: 1

Minimum value: 1 metre

Format: xxx

Example: **250** for a maximum distance between sounding lines of 250 metres.

Remarks:

- No remarks.

28.8 Line spacing minimum (SDISMN)

Line spacing minimum: IHO Definition: The minimum distance between hydrographic survey lines.

Unit: metre

Resolution: 1

Minimum value: 1 metre

Format: xxx

Example: **50** for a minimum distance between sounding lines of 50 metres.

Remarks:

- No remarks.

28.9 Maximum display scale (CSCALE)

Maximum display scale: IHO Definition: The largest intended viewing scale for the data.

Indication: The modulus of the scale is indicated, that is 1:22 000 is encoded as 22000.

Unit: none

Resolution: 1

Minimum value: 1

Format: xxxxxxxx

Example: **12000** for a maximum display scale of scale of 1:12000

Remarks:

- **Maximum display scale** provides a reference for the user selected viewing scale in the ECDIS at which the overscale warning will be displayed if there is no larger maximum display scale ENC dataset available, as well as the ECDIS viewing scale when the cell is loaded.
- For example, based on the scale of the paper chart that was used for the ENC compilation. This attribute is only used in conjunction with the meta feature **Data Coverage** which is used to define polygons of equal largest intended viewing scale. **maximum display scale** should therefore not be confused with the attribute **scale maximum**.

28.10 Measurement distance maximum

Measurement distance maximum: IHO Definition: The maximum spacing of the principal measurement lines of a hydrographic survey.

Unit: metre

Resolution: 0.01 metre

Minimum value: 0

Format: xxx.xx

Example: **30** for a maximum distance between sounding along a sounding line of 30 metres.

Remarks:

- Note that, in spite of the representation of a depth measurement with a single discrete point position, it actually represents an area with a certain footprint on the sea floor.

28.11 Measurement distance minimum

Measurement distance minimum: IHO Definition: The minimum spacing of the principal measurement lines of a hydrographic survey.

Unit: metre

Resolution: 0.01 metre

Minimum value: 0

Format: xxx.xx

Example: **5.75** for a minimum distance between sounding along a sounding line of 5.75 metres.

Remarks:

- Note that, in spite of the representation of a depth measurement with a single discrete point position, it actually represents an area with a certain footprint on the sea floor.

28.12 Minimum display scale

Minimum display scale: IHO Definition: The smallest intended viewing scale for the data.

Indication: The modulus of the scale is indicated, that is 1:700 000 is encoded as 700000.

Unit: none

Resolution: 1

Minimum value: 1

Format: xxxxxxxx

Example: **700000** for a maximum display scale of scale of 1:700000

Remarks:

- **Minimum display scale** is intended to be used in a series of ENC cells covering a geographic area to determine the dataset loading strategy as the user selected viewing scale becomes larger.
- This attribute is only used in conjunction with the meta feature **Data Coverage** which is used to define polygons of equal smallest intended viewing scale. **minimum display scale** should therefore not be confused with the attribute **scale minimum**.

28.13 Orientation uncertainty

Orientation uncertainty: IHO Definition: The best estimate of the accuracy of a bearing.

Unit: Degree (°)

Resolution: 0.001°

Format: xxx.xxx

Minimum value: 0

Maximum value: 360

Example: **0.005** for an error of 0.005 degrees

Remarks:

- No remarks.

28.14 Quality of horizontal measurement (QUAPOS)

Quality of horizontal measurement: IHO Definition: The degree of reliability attributed to a position.

1) Surveyed

IHO Definition: The position(s) was(were) determined by the operation of making measurements for determining the relative position of points on, above or beneath the earth's surface. Survey implies a regular, controlled survey of any date. (Adapted from IHO Dictionary – S-32, & IHO Chart Specifications, M-4, 175.2).

2) Unsurveyed

IHO Definition: Survey data is does not exist or is very poor. (Adapted from IHO Dictionary – S-32).

3) Inadequately surveyed

IHO Definition: Position data is of a very poor quality. (Adapted from IHO Dictionary – S-32).

4) Approximate

IHO Definition: A position that is considered to be less than third-order accuracy, but is generally considered to be within 30.5 metres of its correct geographic location. Also may apply to a feature whose position does not remain fixed. (Adapted from IHO Dictionary – S-32, & IHO Specifications, M-4, 424.1).

5) Position doubtful

IHO Definition: A feature whose position has been reported but which is considered to be doubtful. (S-57 Edition 3.1, Appendix A – Chapter 2, Page 2.256, November 2000).

6) Unreliable

IHO Definition: A feature's position obtained from questionable or unreliable data. (S-57 Edition 3.1, Appendix A – Chapter 2, Page 2.256, November 2000).

7) Reported (not surveyed)

IHO Definition: A feature whose position has been reported and its position confirmed by some means other than a formal survey such as an independent report of the same feature.. (S-57 Edition 3.1, Appendix A – Chapter 2, Page 2.256, November 2000).

8) Reported (not confirmed)

IHO Definition: A feature whose position has been reported and its position has not been confirmed. (S-57 Edition 3.1, Appendix A – Chapter 2, Page 2.256, November 2000).

9) Estimated

IHO Definition: The most probable position of a feature determined from incomplete data or data of questionable accuracy. (Adapted from IHO Dictionary – S-32).

10) Precisely known

IHO Definition: A position that is of a known value, such as the position of an anchor berth or other defined feature..(S-57 Edition 3.1, Appendix A – Chapter 2, Page 2.257, November 2000).

11) Calculated

IHO Definition: A position that is computed from data. (S-57 Edition 3.1, Appendix A – Chapter 2, Page 2.257, November 2000).

Remarks:

- No remarks.

28.15 Scale value maximum (SCVAL1)

Scale value maximum: IHO Definition: The largest scale for the range of survey scale. (Adapted from S-57 Edition 3.1, Appendix A – Chapter 2, Page 2.182, November 2000).

Indication: The modulus of the scale is indicated, that is 1:25 000 is encoded as 25000.

Unit: none

Resolution: 1

Minimum value: 1

Format: xxxxxxxx

Example: **25000** for a scale of 1:25000

Remarks:

- No remarks.

28.16 Scale value minimum (SCVAL2)

Scale value minimum: IHO Definition: The smallest scale for the range of survey scale. (Adapted from S-57 Edition 3.1, Appendix A – Chapter 2, Page 2.183, November 2000).

Indication: The modulus of the scale is indicated, that is 1:250 000 is encoded as 250000.

Unit: none

Resolution: 1

Minimum value: 1

Format: xxxxxxxx

Example: **250000** for a scale of 1:250000

Remarks:

- No remarks.

28.17 Significant features detected

Significant features detected: IHO Definition: A statement expressing if significant features have or have not been detected in the course of a survey.

Indication: Boolean. A True value is an indication that the characteristics of a hydrographic survey are such that significant seafloor features could be detected.

Remarks:

- A feature in this context is any object, whether manmade or not, projecting above the sea floor, which may be a danger for surface navigation (reference: IHO publication S-44). **Significant features detected** does not describe if significant features were actually detected during a hydrographic survey, but whether the

survey had the capacity to detect significant features.

28.18 Size of features detected

Size of features detected: IHO Definition: The size of detected bathymetric features in an area.

Unit: cubic metre

Resolution: 0-01

Minimum value: 1 cubic metre

Format: xxx.xx

Example: **32.5** for a survey capable of detecting significant seafloor features of a minimum size of 32.5 cubic metres.

Remarks:

- A feature in this context is any object, whether manmade or not, projecting above the sea floor, which may be a danger for surface navigation (reference: IHO publication S-44).
- **Size of features detected** does not describe the actual size of features detected during a hydrographic survey, but the size of the smallest feature that the survey was capable of detecting with a high probability.

28.19 Source

Source: IHO Definition: The publication, document, or reference work from which information comes or is acquired.

Indication: Source (c...): String of characters.

Format: c...

Example:

Notice to Mariners 3245/09

Remarks:

- The attribute **source** may be populated with the corresponding paper chart Notice to Mariners numbers, although other references are permitted.

28.20 Survey authority (SURATH)

Survey authority: IHO Definition: The authority which was responsible for the survey. (S-57 Edition 3.1, Appendix A – Chapter 2, Page 2.200, November 2000).

Indication: Survey authority (c...): String of characters.

Format: c...

Example:

**Hydrographic Service, Royal Australian Navy
Port of Melbourne Authority**

Remarks:

- The attribute “survey authority” encodes the name of the source survey authority.

28.21 Survey type (SURTYP)

Survey type: IHO Definition: **Definition required.**

1) **Reconnaissance/sketch survey**

IHO Definition: A survey made to a lower degree of accuracy and detail than the chosen scale would normally indicate. (IHO Dictionary – S-32).

2) **Controlled survey**

IHO Definition: A thorough survey usually conducted with reference to guidelines. (S-57 Edition 3.1, Appendix A – Chapter 2, Page 2.203, November 2000).

4) **Examination survey**

IHO Definition: A survey principally aimed at the investigation of underwater obstructions and dangers. (S-57 Edition 3.1, Appendix A – Chapter 2, Page 2.203, November 2000).

5) **Passage survey**

IHO Definition: A survey where soundings are acquired by vessels on passage. (S-57 Edition 3.1, Appendix A – Chapter 2, Page 2.203, November 2000).

6) **Remotely sensed**

IHO Definition: A survey where features have been positioned and delimited using remote sensing techniques. (S-57 Edition 3.1, Appendix A – Chapter 2, Page 2.203, November 2000).

7) **Full coverage**

IHO Definition: A survey achieving 100% coverage using systematic, controlled techniques providing full seafloor coverage or full coverage to a defined depth and an investigation of all contacts.

8) **Systematic survey**

IHO Definition: A controlled survey but full coverage may not have been achieved.

9) **Non-systematic survey**

IHO Definition: A survey of lower quality than a full coverage and systematic survey. Such surveys may be further categorised as reconnaissance, sketch, track, passage, remotely sensed and spot-sounding surveys.

10) **Inadequately surveyed**

IHO Definition: A survey that is not to modern standards, or which, due to its age, scale, or positional or vertical uncertainties is not suitable to the type of navigation expected in the area.

11) **Spot-sounding survey**

IHO Definition: A survey that uses a regular (for example grid) or irregular pattern of soundings obtained one at a time, and normally with very wide spacing.

12) **Acoustically swept survey**

IHO Definition: A controlled, systematic survey to standard accuracy; using modern survey echo sounder with sonar sweep.

13) **Mechanically swept survey**

IHO Definition: Swept areas where the clearance depth is accurately known but the actual seabed depth is not accurately known.

Remarks:

- No remarks.

28.22 Uncertainty fixed (*SOUACC*, *VERACC*)

Uncertainty fixed: IHO Definition: The best estimate of the fixed vertical accuracy component for depths, heights, vertical distances and vertical clearances.

Unit: Defined as an attribute in the ENC dataset metadata: metre (m).

Resolution: 0.1m

Format: xx.x

Example: **1.2** for an error of 1.2 metres

Remarks:

- The maximum of the one-dimensional error. The error is assumed to be positive and negative. The plus/minus character must not be encoded.

28.23 Uncertainty variable

Uncertainty variable: IHO Definition: The best estimate of the variable vertical accuracy component for depths, heights, vertical distances and vertical clearances.

Unit: Defined as an attribute in the ENC dataset metadata: metre (m).

Resolution: 0.1m

Format: xx.x

Example: **0.5** for an error of 0.5 metres

Remarks:

- The maximum of the one-dimensional error. The error is assumed to be positive and negative. The plus/minus character must not be encoded.

29 Complex Attributes

29.1 Directional character

Directional character: IHO Definition: A directional light is a light illuminating a sector of very narrow angle and intended to mark a direction to follow. (IHO Dictionary – S-32).

Indication: The complex attribute defines whether the light is a moiré effect light and encodes the orientation of the directional light sector.

Sub-attributes: **Moiré effect** see clause X.X
Orientation see clause X.X

Remarks:

- No remarks.

29.2 Feature name

Feature name: IHO Definition:

Indication: The complex attribute provides the name of an entity, defines the national language of the name, and provides the option to display the name at various system display settings.

Sub-attributes: **Display name** see clause X.X
Language see clause X.X
Name see clause X.X

Remarks:

- No remarks.

29.3 Features detected

Features detected: IHO Definition: The uniform assessment of detected features.

Indication:

Sub-attributes: **Least depth of detected features measured** see clause X.X
Significant features detected see clause X.X
Size of features detected see clause X.X

Remarks:

- A feature in this context is meant to be any object, whether manmade or not, projecting above the sea floor, which may be a danger for surface navigation. (Refer IHO document S-44). **Features detected** does not describe if features were actually detected during a hydrographic survey, but whether the survey had the capacity to detect features.

29.4 Fixed date range

Fixed date range: IHO Definition: **Definition required.**

Indication: The complex attribute describes single fixed period, as the date range between its sub-attributes.

Sub-attributes: **Date end** see clause X.X
Date start see clause X.X

Remarks:

- The sub-attributes **date start** and **date end** must be encoded using 4 digits for the calendar year (YYYY) and, optionally, 2 digits for the month (MM) (for example April = 04) and 2 digits for the day (DD). When no specific month and/or day is required/known, the values are replaced with dashes (-).

29.5 Frequency pair (SIGFRQ)

Frequency pair: IHO Definition: A pair of frequencies for transmitting and receiving radio signals. The shore station transmits and receives on the frequencies indicated.

Indication: The complex attribute describes all variations of radio receiving and transmitting.

Sub-attributes: **Frequency shore station receives** see clause X.X
Frequency shore station transmits see clause X.X

Remarks:

- No remarks.

29.6 Horizontal clearance fixed

Horizontal clearance fixed: IHO Definition: The horizontal clearance measured between for a fixed span.

Indication: The complex attribute encodes the horizontal distance

Sub-attributes: **Horizontal clearance value** see clause X.X
Horizontal distance uncertainty see clause X.X

Remarks:

- No remarks.

29.7 Horizontal clearance open

Horizontal clearance open: IHO Definition: The horizontal clearance measured between for an opening span.

Indication: The complex attribute encodes the horizontal distance

Sub-attributes: **Horizontal clearance value** see clause X.X
Horizontal distance uncertainty see clause X.X

Remarks:

- No remarks.

29.8 Information

Information: IHO Definition: Textual information about the feature in a defined language. The information may be provided as a string of text or as a file name of a single external text file that contains the text. (Adapted from S-57 Edition 3.1, Appendix A – Chapter 2, Pages 2.141 and 2.209, November 2000).

Indication: The complex attribute provides additional textual information that cannot be provided using other allowable attributes for the feature, and defines the language of the text string.

Sub-attributes: **File locator** see clause X.X
File reference see clause X.X
Headline see clause X.X
Language see clause X.X
Text see clause X.X

Remarks:

- At least one of the sub-attributes **file reference** or **text** must be populated.
- The sub-attribute **file reference** is generally used for long text strings or those that require formatting, however, there is no restriction on the type of text (except for lexical level) that can be held in files referenced by sub-attribute **file reference**.

- The sub-attribute **file locator** cannot be populated unless the attribute **file reference** is populated.
- This complex attribute should be used, for example, to hold the information that is shown on paper charts by cautionary and explanatory notes.

29.9 Light sector

Light sector: IHO Definition: A sector is the part of a circle between two straight lines drawn from the centre to the circumference. (Advanced Learner's Dictionary, 2nd Edition).

Indication:

<u>Sub-attributes:</u> Colour	see clause X.X
Directional character	see clause X.X
Light visibility	see clause X.X
Sector limit	see clause X.X
Value of nominal range	see clause X.X
Sector information	see clause X.X
Sector extension	see clause X.X

Remarks:

- No remarks.

29.10 Measured distance value

Measured distance value: IHO Definition: The distance value indicated on a distance mark, or the distance between two measured distance marks.

Indication:

<u>Sub-attributes:</u> Distance unit of measurement	see clause X.X
Reference location	see clause X.X
Waterway distance	see clause X.X

Remarks:

- No remarks.

29.11 Multiplicity of features

Multiplicity of features: IHO Definition: The number of features of identical character that exist as a co-located group. (Adapted from S-57 Edition 3.1, Appendix A – Chapter 2, Page 2.150, November 2000).

Indication: The complex attribute provides an indication as to whether the true number of features is known and, where known, the number of features.

<u>Sub-attributes:</u> Multiplicity known	see clause X.X
Number of features	see clause X.X

Remarks:

- The attribute **multiplicity of features** must only be used to indicate the number of entities of a feature that are co-located (for example 3 overhead cables suspended over a body of water between 2 pylons), and this information is considered to be of use to the mariner. Where possible, features must be encoded individually.

29.12 Online resource

Online resource: IHO Definition: Information about online sources from which a resource or data can be obtained. (Adapted from ISO 19115).

Indication: The complex attribute describes the access to online resources according to ISO 19115.

Sub-attributes:

Headline	see clause X.X
Linkage	see clause X.X
Name of resource	see clause X.X

Remarks:

- No remarks.

29.13 Orientation

Orientation: **IHO Definition:** The angular distance measured from true north to the major axis of the feature. (Defence Geospatial Information Working Group; Feature Data Dictionary Register, 2010).

Indication: The complex attribute provides the orientation value together with a measure of the uncertainty of the value.

Sub-attributes:

Orientation uncertainty	see clause X.X
Orientation value	see clause X.X

Remarks:

- No remarks.

29.14 Periodic date range

Periodic date range: **IHO Definition:** .

Indication: The complex attribute describes the active period for a seasonal feature (for example a buoy), as the dates between its sub-attributes.

Sub-attributes:

Date end	see clause X.X
Date start	see clause X.X

Remarks:

- The sub-attributes **date start** and **date end** should be encoded using 4 digits for the calendar year (YYYY), 2 digits for the month (MM) (for example April = 04) and 2 digits for the day (DD). When no specific year is required (that is, the feature is removed at the same time each year) the following two cases may be considered:
 - same day each year: ----MMDD
 - same month each year: ----MM--

This conforms to ISO 8601:2004.

29.15 Radar wave length

Radar wave length: **IHO Definition:** The distance between two successive peaks (or other points of identical phase) on an electromagnetic wave in the radar band of the electromagnetic spectrum. (S-57 Edition 3.1, Appendix A – Chapter 2, Page 2.172, November 2000).

Indication: The complex attribute describes the wave length, as the combination of its sub-attributes.

Sub-attributes:

Radar band	see clause X.X
Wave length value	see clause X.X

Remarks:

- No remarks.

29.16 Rhythm of light

Rhythm of light: IHO Definition:

Indication: The complex attribute describes the rhythm of a light (or a light sector).

Sub-attributes:

Light characteristic	see clause X.X
Signal group	see clause X.X
Signal period	see clause X.X
Signal sequence	see clause X.X

Remarks:

- No remarks.

29.17 Schedule by day of week

Vertical uncertainty: IHO Definition: The nature and timings of a daily schedule by days of the week.

Indication: The complex attribute encodes the regular schedule for a service.

Sub-attributes:

Category of schedule	see clause X.X
Time intervals by day of week	see clause X.X

Remarks:

- No remarks.

29.18 Sector characteristics

Sector characteristic: IHO Definition:

Indication: The complex attribute describes the characteristics of a light sector.

Sub-attributes:

Light characteristic	see clause X.X
Light sector	see clause X.X
Signal group	see clause X.X
Signal period	see clause X.X
Signal sequence	see clause X.X

Remarks:

- No remarks.

29.19 Sector information

Sector information: IHO Definition: Additional textual information about a light sector.

Indication: The complex attribute provides additional textual information that cannot be provided using other allowable attributes for the feature, and defines the language of the text string.

Sub-attributes:

Language	see clause X.X
Text	see clause X.X

Remarks:

- This complex attribute should be used, for example, to hold the information related to the characteristics of a complex light sector.
- No formatting of text is possible within **sector information**. If formatted text is required, then an associated text file referenced by the complex attribute **textual information** must be used (see clause X.X).

29.20 Sector limit

Sector limit: IHO Definition: A sector is the part of a circle between two straight lines drawn from the centre to the circumference. (Advanced Learner's Dictionary, 2nd Edition).

The sector limit specifies the limits of the sector In a clockwise direction around the central feature (for example a light). (Adapted from S-57 Edition 3.1, Appendix A – Chapter 2, Page 2.184, November 2000).

Indication: The complex attribute describes the angle of a light sector as defined by the sub-attributes.

Sub-attributes: **Sector limit one** see clause X.X
Sector limit two see clause X.X

Remarks:

- No remarks.

29.21 Sector limit one

Sector limit one: IHO Definition: A sector is the part of a circle between two straight lines drawn from the centre to the circumference. (Advanced Learner's Dictionary, 2nd Edition).

Sector limit one specifies the first limit of the sector. The order of **sector limit one** and **sector limit two** is clockwise around the central feature (for example a light). (S-57 Edition 3.1, Appendix A – Chapter 2, Page 2.184, November 2000).

Indication: The complex attribute describes the line or bearing of a light where the character changes or the light is obscured.

Sub-attributes: **Sector bearing** see clause X.X
Sector line length see clause X.X

Remarks:

- The values given to the common limits of adjacent sectors should be identical.
- The orientation of the bearing is from seaward to the central feature. This conforms with the method used in "List of Lights" publications.
- A generic term such as "to shore" cannot be used; a specific bearing must be encoded. Where a light sector limit is defined as "to the shore", it should be encoded using a value that ensures that, when the limit is drawn, it will fall entirely on land.

29.22 Sector limit two

Sector limit two: IHO Definition: A sector is the part of a circle between two straight lines drawn from the centre to the circumference. (Advanced Learner's Dictionary, 2nd Edition).

Sector limit two specifies the second limit of the sector. The order of **sector limit one** and **sector limit two** is clockwise around the central feature (for example a light). (S-57 Edition 3.1, Appendix A – Chapter 2, Page 2.184, November 2000).

Indication: The complex attribute describes the line or bearing of a light where the character changes or the light is obscured.

Sub-attributes: **Sector bearing** see clause X.X
Sector line length see clause X.X

Remarks:

- The values given to the common limits of adjacent sectors should be identical.
- The orientation of the bearing is from seaward to the central feature. This conforms with the method used in "List of Lights" publications.
- A generic term such as "to shore" cannot be used; a specific bearing must be encoded. Where a light sector limit is defined as "to the shore", it should be encoded using a value that ensures that, when the limit is drawn, it will fall entirely on land.

29.23 Shape information

Shape information: IHO Definition: Textual information about the shape of a non-standard topmark.

Indication: The complex attribute provides additional textual information that cannot be provided using the attribute **topmark/daymark shape**.

Sub-attributes: **Language** see clause X.X
Text see clause X.X

Remarks:

- No formatting of text is possible within **shape information**. If formatted text is required, then an associated text file referenced by the complex attribute **information** must be used (see clause X.X).

29.24 Signal sequence

Signal sequence: IHO Definition: The sequence of times occupied by intervals of light and eclipse for all "light characteristics". (Adapted from S-57 Edition 3.1, Appendix A – Chapter 2, Page 2.191, November 2000).

Indication: The complex attribute provides the signal sequence for non-fixed lights.

Sub-attributes: **Signal duration** see clause X.X
Signal status see clause X.X

Remarks:

- No remarks.

29.25 Speed

Speed: IHO Definition: Rate of motion. The terms speed and velocity are often used interchangeably, but speed is a scalar, having magnitude only, while velocity is a vector quantity, having both magnitude and direction. (Adapted from IHO Dictionary, S-32).

Indication: The complex attribute encodes the range of the speed at a location.

Sub-attributes: **Speed maximum** see clause X.X
Speed minimum see clause X.X

Remarks:

- No remarks.

29.26 Surface characteristics

Surface characteristics: IHO Definition: The general nature of the material of which the land surface or the seabed is composed.

Indication:

Sub-attributes: **Nature of surface** see clause X.X
Nature of surface – qualifying terms see clause X.X
Underlying layer see clause X.X

Remarks:

- No remarks.

29.27 Survey date range

Survey date range: IHO Definition: .

Indication: The complex attribute describes the period of the hydrographic survey, as the time between its sub-attributes.

Sub-attributes: **Date end** see clause X.X
Date start see clause X.X

Remarks:

- The sub-attributes **date start** and **date end** must be encoded using 4 digits for the calendar year (YYYY) and, optionally, 2 digits for the month (MM) (for example April = 04) and 2 digits for the day (DD). When no specific month and/or day is required/known, indication of the month and/or day is replaced with dashes (-).

29.28 Telecommunications

Telecommunications: IHO Definition: A means or channel of communicating at a distance by electrical or electromagnetic means such as telegraphy, telephony, or broadcasting.

Indication: The complex attribute describes the different telecommunications methods and contact details.

Sub-attributes: **Contact instructions** see clause X.X
Telecommunication identifier see clause X.X
Telecommunication service see clause X.X

Remarks:

- If no value is populated for the sub-attribute **telecommunication service**, this means the service is by voice communication.

29.29 Tidal stream panel values

Tidal stream panel values: IHO Definition: The direction of the flow and the springs rate from 6 hours before to 6 hours after high water (HW) or low water (LW) at the reference tide station, at hourly or sub-hourly intervals.

Indication:

Sub-attributes: **Reference tide** see clause X.X
Reference tide type see clause X.X
Stream depth see clause X.X
Tidal stream value see clause X.X

Remarks:

- No remarks.

29.30 Tidal stream value

Tidal stream value: IHO Definition: A measurement of the direction and **speed** of a tidal stream at a given time relative to the reference tide.

Indication:

Sub-attributes: **Orientation** see clause X.X
Speed maximum see clause X.X
Time relative to tide see clause X.X

Remarks:

- No remarks.

29.31 Time intervals by day of week

Sector characteristic: IHO Definition: **Definition required.**

Indication: The complex attribute describes the timings for a regular service schedule.

Sub-attributes:

Day of week	see clause X.X
Day of week is range	see clause X.X
Time of day end	see clause X.X
Time of day start	see clause X.X
Time reference	see clause X.X

Remarks:

- At least one of the sub-attributes **day of week**, **time of day start** or **time of day end** must be encoded. Where populated, the number of instances of **time of day start** must be the same as the number of instances of **time of day end**.
- The sub-attribute **day of week is range** indicates whether an instance of **time intervals by day of week** encodes a range of days or discrete days. The day(s) or day range(s) are encoded using sub-attribute **day of week**. Where **day of week is range** is populated as *True*, there must be exactly two instances of the attribute **day of week**. If **day of week** is not populated, this indicates that the same schedule applies every day (Monday through Sunday). Multiple ranges or mixing range with discrete days(s) is not allowed (if this is required another instance of **time intervals by day of week** must be encoded).
- An indeterminate range may be indicated with a null value at the appropriate position in the sequence.

29.32 Topmark

Topmark: IHO Definition: A characteristic shape secured at the top of a buoy or beacon to aid in its identification. (IHO Dictionary – S-32).

Indication:

Sub-attributes:

Colour	see clause X.X
Topmark/daymark shape	see clause X.X
Shape information	see clause X.X

Remarks:

- No remarks.

29.33 Update description

Update description: IHO Definition: The textual description of changes included in an update.

Indication: The complex attribute provides additional textual information describing changes made to an ENC dataset resulting from application of an ENC Update.

Sub-attributes:

Language	see clause X.X
Text	see clause X.X

Remarks:

- The sub-attribute **text** is populated with a brief description of the changes made when the Update is applied, for example: **Navigational aids inserted**
Changes to depths alongside and new pontoons added

29.34 Value of local magnetic anomaly

Value of local magnetic anomaly: IHO Definition: The value of the deviation from the normal magnetic variation. (S-57 Edition 3.1, Appendix A – Chapter 2, Page 2.228, November 2000).

Indication: The complex attribute encodes the range of the local magnetic anomaly.

Sub-attributes: **Magnetic anomaly value maximum** see clause X.X
Magnetic anomaly value minimum see clause X.X

Remarks:

- No remarks.

29.35 Vertical clearance closed

Vertical clearance closed: IHO Definition: The vertical clearance of a feature in closed condition (for example a closed lifting bridge) measured from the horizontal plane towards the feature overhead. (Adapted from S-57 Edition 3.1, Appendix A – Chapter 2, Page 2.235, November 2000).

Indication: The complex attribute encodes the vertical distance from a defined vertical datum to the underside of an opening overhead feature when it is in the closed position.

Sub-attributes: **Vertical clearance value** see clause X.X
Vertical uncertainty see clause X.X

Remarks:

- No remarks.

29.36 Vertical clearance fixed

Vertical clearance fixed: IHO Definition: The vertical clearance measured from the horizontal plane towards a fixed (non-opening) feature overhead. (Adapted from S-57 Edition 3.1, Appendix A – Chapter 2, Page 2.234, November 2000).

Indication: The complex attribute encodes the vertical distance from a defined vertical datum to the underside of a fixed overhead feature.

Sub-attributes: **Vertical clearance value** see clause X.X
Vertical uncertainty see clause X.X

Remarks:

- In the case of cables carrying high voltages an additional clearance of from 2 to 5 metres may be needed to avoid an electrical discharge. When known, the authorised safe clearance (known in the UK as the Safe Overhead Clearance) which is the physical clearance minus a safety margin shall be stated, using the attribute **vertical clearance safe** (see clause X.X). **vertical clearance fixed** must not be used to populate authorized safe clearances.

29.37 Vertical clearance open

Vertical clearance open: IHO Definition: The vertical clearance of a feature in opened condition (for example an open lifting bridge) measured from the horizontal plane towards the feature overhead. (Adapted from S-57 Edition 3.1, Appendix A – Chapter 2, Page 2.236, November 2000).

Indication: The complex attribute encodes the vertical distance from a defined vertical datum to the underside of an opening overhead feature when it is in the open position.

Sub-attributes: **Vertical clearance value** see clause X.X
Vertical uncertainty see clause X.X

Remarks:

- No remarks.

29.38 Vertical clearance safe

Vertical clearance safe: IHO Definition: The safe vertical clearance of a feature measured from the

horizontal plane towards the feature overhead. (Adapted from S-57 Edition 3.1, Appendix A – Chapter 2, Page 2.237, November 2000).

Indication: The complex attribute encodes the safe vertical distance from a defined vertical datum to the lowest point of an electrical cable over navigable water.

Sub-attributes: **Vertical clearance value** see clause X.X
Vertical uncertainty see clause X.X

Remarks:

- No remarks.

29.39 Vertical uncertainty

Vertical uncertainty: **IHO Definition:** The best estimate of the vertical accuracy of depths, heights, vertical distances and vertical clearances.

Indication: The complex attribute encodes the vertical uncertainty associated with any vertical measurement.

Sub-attributes: **Uncertainty fixed** see clause X.X
Uncertainty variable see clause X.X

Remarks:

- No remarks.

29.40 Vessel speed limit

Vessel speed limit: **IHO Definition:** The maximum allowed rate of travel for a vessel in an area in knots.

Indication: The complex attribute describes the speed limit for vessels in an area where speed is restricted.

Sub-attributes: **Speed limit** see clause X.X
Vessel class see clause X.X

Remarks:

- The speed limit in an area may differ for different classes of vessel.

30 ECDIS System (Portrayal) Attributes

30.1 Default clearance depth

Default clearance depth: IHO Definition: The depth value determined for an underwater hazard of unknown depth, based on the depth of the surrounding area.

Unit: Defined as an attribute in the ENC dataset metadata: metre (m)

Resolution: 0.1m

Format: sxxxxx.x

s: sign, negative values only

Examples: **12.5** for a default clearance depth of 12.5 metres

-2.4 for a drying default clearance height of 2.4 metres

Remarks:

- The depth of the surrounding area is determined from the surrounding encoded **Depth Area** and is encoded using the attribute **surrounding depth** (see clause X.X).
 - **[Insert algorithm here?]**
- A drying height is indicated by a negative value.

30.2 Flare angle

Flare angle: IHO Definition: The angle about which the light flare symbol is rotated to be displayed in ECDIS.

Indication: Indicates the angle of the light flare to be included in the data for ECDIS display purposes where different from the default. Required where there is more than one light encoded on an instance of point spatial geometry.

Unit: Degree (°)

Resolution: 1°

Format: xxx

Minimum value: 0

Maximum value: 359

Example: **270** for an flare angle of 270 degrees

Remarks:

- The flare angle is calculated by ENC production software systems.

30.3 In the water

In the water: IHO Definition:

Indication: Boolean. A True value is an indication that the feature is located in or over navigable water.

Remarks:

- A True value is an indication that the feature is to be included in the ECDIS Base Display viewing group.

30.4 Sector extension

Sector extension: IHO Definition: The distance in screen millimeters (mm) by which a sector is extended from its origin.

Indication: Indicated the distance that a displayed sector arc is to be extended beyond the default. Required

where there is more than one light sector covering the same or similar angle..

Unit: Millimetre (mm)

Resolution: 1 mm

Format: xx

Example: **15** for an extension to the sector of 15 mm.

Remarks:

- The sector extension is calculated by ENC production software systems.
- The displayed sector must not exceed the nominal range of the light sector on the ECDIS display.

30.5 Surrounding depth

Surrounding depth: IHO Definition: The depth value determined for seabed around an underwater hazard of unknown depth, based on the depth of the surrounding area.

Unit: Defined as an attribute in the ENC dataset metadata: metre (m)

Resolution: 0.1m

Format: xxxxx.x

Example: **20** for a surrounding depth of 20 metres

Remarks:

- The value for **surrounding depth** is determined from the attribute **depth range minimum value** for the surrounding encoded **Depth Area** (see clause X.X). For an area feature covered by more than one depth area, the **surrounding depth** is determined as the **depth range minimum** attribute value of the deeper of the depth areas covering the feature.

31 Updating (see S-4 – B-600)

Remarks:

- An ENC Update will be rejected by the ECDIS if it is located outside the area of data coverage for the dataset (that is, area covered by the meta feature **Data Coverage** with attribute **category of coverage** = 1 (coverage available)) or if it changes the extent of this area. Where the area of data coverage for a base ENC dataset is to be changed, this must be done by issuing a New Edition of the dataset.
- It has been reported that some ECDIS experience problems in loading large Update datasets. Therefore, as a guide, ENC Updates should not exceed 50 Kilobytes in size.
- When updating the geometry of linear features, compilers must note S-101 clause X.X regarding the requirement for the vector records making up the linear feature to be referenced sequentially. Additionally, for linear features comprising multiple edges, the end node of a vector record must be the same as the start node of the following vector record. It has been reported that some ECDIS reject ENC Updates where the geometry does not conform to these requirements.

31.1 Issuing Updates in advance

Under certain conditions, it may be necessary for a data producer to issue Update information in advance. For example, a change in a traffic routing system must be made public before the new situation is implemented. Within an ER dataset there is no means of indicating the date at which an Update must be applied. Therefore, when an ER dataset is received by an end user, it must be applied immediately. To avoid situations where Update information would cause target data to reflect a situation that does not yet exist, the following encoding rules must be followed:

a) If the advance Update information contained in the Update message involves the addition of features to the existing data (for example a new lighthouse), the **start date** sub-attribute for the complex attribute **fixed date range** on the new features must contain the date at which the Update becomes active.

b) If the advance Update information contained in the Update message involves the modification of existing features (for example a change in a traffic routing system), it must be treated as a deletion of the existing features and replacement with new features. See a) above and c) below.

c) If the advance Update information contained in the Update message involves the deletion of existing features (for example the removal of a buoy), the Update message must set the **end date** sub-attribute for the complex attribute **fixed date range** of all features to be deleted to the date at which the Update becomes active. **NB.** This Update message does not actually delete the features from the dataset, it simply indicates that on the date held in the **end date** sub-attribute for the complex attribute **fixed date range** they become obsolete. A further Update to actually delete the obsolete features from the dataset should be sent at the time that the change in the real world occurs.

d) To highlight to the mariner that the advance Update information contained in an Update message will take place in the future, it is recommended that a **Caution Area** feature (see clause X.X) be created covering the location at which the future changes will take place. A warning note specifying, in plain language, the nature of the future change should be encoded, using an associated instance of the information class **Nautical Information** (see clause X.X), complex attribute **information**. The sub-attribute **end date** sub-attribute for the complex attribute **fixed date range** on the **Caution Area** must be set to the date at which the change described in the Update becomes active.

Changes to the **start date** and **end date** for **fixed date range** cannot be applied to spatial types. Therefore, a change to the geometry of a real world feature (for example the relocation of a buoy) to be applied in the future can only be achieved by updating all of the geo and spatial types involved.

As a consequence of issuing advance information Updates, more than one instance of a particular real world feature could exist in the dataset.

Further information regarding issuing Update information in advance as an equivalent to the paper chart Preliminary Notices to Mariners process can be found at clause X.X.

31.1.1 Advance notification of changes to traffic separation schemes

It is important that mariners be provided with advance notification of changes to traffic separation schemes (TSS), which may include modification to an existing TSS, addition of a new TSS or removal of a TSS. In order to provide a consistent approach to mariners regarding advance notification of changes to a traffic separation scheme, the following procedure should be adopted:

- 1) At least one month before the changes to the TSS come into force, issue an updated dataset (as an Update or a New Edition) which:
 - Adds new or amended TSS component features. These features must have **start date** for **fixed date range** populated with the date that the changes to the TSS come into force.
 - Adds **end date** for **fixed date range** (populated with the date of the day before the changes to the TSS come into force) to any component features of the existing TSS that are to be changed or deleted.
 - Creates a **Caution Area** surface feature (see clause X.X) covering the geographic extent of both the current and the future TSS. An associated instance of the information class **Nautical Information** (see clause X.X), attribute **information** must be used to explain the change to the TSS, for example *“The traffic separation scheme off Cape Bon is to be modified at 0000 UTC on 1 July 2009. This ENC includes all the information before and after the change, indicated by the sub-attributes **end date** (before the change) and **start date** (after the change) for the complex attribute **fixed date range** on the components of the scheme”*. The sub-attribute **end date** on **fixed date range** for the **Caution Area** should be populated with the date at which the change comes into force or, if encoders wish to provide extended information to the mariner that a change has been made, with a date up to a month after the change comes into force. If the current and the future TSS are not in the same geographic area, it may be required to encode two distinct **Caution Area** surface features. A picture file may be referenced by the **Caution Area** using the attribute **pictorial representation** if it is considered useful, for example the equivalent paper chart representation of the amended or new TSS.
- 2) As soon as possible after the modified/new/deleted TSS comes into force, issue an updated dataset (as an Update or New Edition) which:
 - Deletes the changed or redundant component features of the former TSS.
 - Removes the attribute **fixed date range** from the component features of the new TSS.
- 3) The **Caution Area** must also be removed by Update, either as part of the Update to remove the redundant component features of the former TSS, or as a separate Update at a later date, corresponding to the date populated in the sub-attribute **end date** for the complex attribute **fixed date range** for the **Caution Area**.

Encoders who are members of RENCs should also provide advance notification of changes to TSS to their RENC in accordance with RENC procedures, in order for the RENC to provide additional notification to mariners of impending TSS changes.

31.2 Guidelines for encoding Temporary and Preliminary ENC Updates

31.2.1 Introduction

The following provides high level guidance for the promulgation of the equivalent of paper chart Temporary (T) and Preliminary (P) Notices to Mariners (NMs) via ENC Updates. This guidance allows for some latitude in its application and is dependent on the assessment of each particular case, and as such relies ultimately on the judgement of each ENC Producing Authority.

31.2.2 Temporary (T) Notices to Mariners (see S-4 – B-633)

1. Temporary Notices to Mariners, (T)NMs, for paper charts are defined in S-4, Section B-600. A (T)NM promulgates navigationally significant information that will remain valid only for a limited period of time.

For the paper chart, the convention is for the mariner to insert the Update on the chart in pencil, and erase it when the (T)NM is cancelled.

S-101 provides mechanisms which allow ENCs to be automatically updated. This allows the affected ENC(s) to be continually updated in a timely manner for the duration of the NM without additional workload for the mariner.

Producing Authorities must promulgate temporary information which is safety-related or which otherwise needs to be advised to the mariner urgently by ENC Update to provide the ECDIS user with an updated SENC. This service corresponds to the service that (T)NMs offer to the paper chart user.

2. ER encoding for an ENC and (T)NM for the paper chart are two completely different communication processes for promulgating information to the mariner. Since these processes are different (but not supposed to be independent), and the products to which they apply are also different, it is recommended that ENC Updates be derived from the source information rather than the paper chart (T)NM. Often the (T)NM for paper chart does not provide enough detail to apply the relevant ENC Update.
3. If possible the information should be encoded with the relevant features. However, HO's should consider the following:
 - An ENC Update must not be initiated if the information will no longer be valid by the time it is received by the mariner; this will depend upon the timescales relating to the Producer Nation's ENC Updating regime. Shorter time periods may be covered by Radio Navigational Warnings (RNW). If known, the ENC Update should include an indication of how long the temporary change will remain in force.
 - If it is unlikely that the HO will be notified when a temporary change will revert to its original charted state, the HO should consider an alternative method such as a general note or by issuing an ENC Update explaining, for example, that the aids to navigation within an area are reported to be unreliable.

It is important that HO's should consider constraints of time when identifying the encoding method. Time consuming and unnecessarily complex methods of encoding should be avoided.

4. The overuse of **Caution Area** features (especially **Caution Area** of type surface – see clause X.X) for temporary information should be avoided. The **Caution Area** feature is used when it is relevant for the situation and/or when a particular change needs a special warning. **Caution Area** may be used when the relevant features cannot be encoded, for example information cannot be displayed clearly or cannot be easily promulgated due to time constraints.
5. To correctly encode an ENC Update the source information is essential in determining which elements of the Update are reliable, which are permanent and which are temporary. The attribute **Status** with value 7 (temporary) should only be used in an Update when it is certain that the status of a feature is confirmed as temporary.
6. Use of complex attribute **fixed date range**:

The earliest date on which a feature will be present (**start date**) and the latest date on which a feature will be present (**end date**) must only be encoded when known. When these dates are encoded for navigational aids, **fixed date range** must be populated on each component of the aid.

The ENC Update should be issued as close as possible to the earliest date of the change (**start date**), unless it is appropriate to provide the information well in advance. A feature no longer present should be removed from the display by issuing a further Update as soon as possible after the return to the original charted state (**end date**). The timing of the issue of these Updates will depend upon the Producing Authorities ENC Updating regime and its corresponding timescales.

When an ENC Update promulgates information well in advance and uses **fixed date range**, a **Caution Area** feature may be used in order to inform mariners that temporal information exists at some future point in time.

7. An associated instance of the information class **Nautical Information** (see clause X.X), complex attribute **information**, sub-attribute **text** should be used to provide supplementary or contextual information when encoding temporary (or preliminary) information. When the text is too long to be encoded using **information (text)** (see clause X.X), the complex attribute **information**, sub-attribute **file reference** should be used. Encoders using **information** to provide positional information must express the coordinate values in WGS 84 and in accordance with S-4 – B-131. If it is deemed necessary a picture file (referenced using attribute **pictorial representation**) may be included.
8. ENC Updates issued for temporary information should be carefully managed and reviewed regularly to consider whether further action is necessary. New information may have been

received that necessitates the issuing of a new Update to modify or cancel the previous one. Producing Authorities should make it easy to recover the original charted state before the temporary changes came into effect.

9. Further verification is recommended to make sure that the encoded ENC Update is consistent with the corresponding paper chart NM.

10. Guidelines for typical cases:

- a) Individual new physical features (for example wreck, buoy) with no associated explicit or implicit area associated (for example restricted area):
 - Encode the relevant S-101 feature.
 - In this instance a **Caution Area** feature would not normally be used.
- b) Individual new physical feature(s) with an associated explicit area around it:
 - Encode the relevant S-101 surface feature (for example **Restricted Area Navigational** or **Restricted Area Regulatory**). The relevant feature is encoded for the new physical feature. However, when the area is an “entry prohibited area” or a **Caution Area** feature the new physical feature(s) may be omitted to simplify encoding unless it is navigationally significant.
- c) Individual new physical feature with a notification of caution, for example “Mariners are advised to navigate with caution...”:
 - Encode the relevant S-101 feature. Additional clarification and advice may, if required, be provided using an associated instance of the information class **Nautical Information** (see clause X.X), complex attribute **information**. Exceptionally, a **Caution Area** feature may be encoded to highlight the caution if considered necessary.
- d) Obstructions (including wrecks) reported to exist within an area:
 - Encode an **Obstruction** or **Wreck** feature of type surface (see clauses X.X and X.X).
- e) New simple surface feature (military practice area, dredged area):
 - Encode the relevant S-101 surface feature.
 - Supplementary information is provided using an associated instance of the information class **Nautical Information** (see clause X.X), complex attribute **information**.
 - Normally, a **Caution Area** feature is not added.
- f) Complex information within an area (for example works in progress where the changes are numerous or involve complex changes to the topology):
 - Encode the surface feature. It should be encoded with the relevant S-57 feature or, if more suitable or by default, a **Caution Area** feature (see clause X.X). Supplementary or contextual information is provided using an associated instance of the information class **Nautical Information** (see clause X.X), complex attribute **information**. When the available information is sufficiently detailed, navigationally significant features (for example navigational aids, obstructions) should be encoded or modified within the area. When the available information does not permit this, a **Caution Area** feature defining the area is preferred.
- g) Changes to an existing feature (for example navigational aid):
 - In these instances it is usually only necessary to change the attributes values. A **Caution Area** feature (see clause X.X) may be used to warn the mariner if it is considered necessary.
- h) Buoy temporarily moved:
 - When a buoy is temporarily moved then it, and any associated features, are “moved” to the new position and the attribute **status** = 7 (temporary) is populated. Alternative encodings are possible, for example, if the move is for a fixed period of time. In these cases the feature, and any associated components, can be created in the temporary position with sub-attribute **end date** for the complex attribute **fixed date range** populated with the date corresponding to the end of the fixed period of time. The currently charted feature, and any associated components, should have **start date** for the complex attribute **fixed date range** also populated with the date corresponding to the end of the fixed period of time. A **Caution Area** feature may, if considered necessary, be added. Data producers may wish to consider the NOTE in section 6 above.
- i) Light temporarily extinguished:

- The attribute **status** for the **Light** feature is populated with the values 11 (extinguished) and 7 (temporary).
- j) Change to a maintained depth in a dredged area:
- When information is received from an official or recognised survey authority relating to a dredged area where the dredged depth has changed, the attribute value of **depth range minimum value** for the **Dredged Area** feature should be changed to the value provided by the survey.
 - Where a **Sounding** feature is encoded in a dredged area to indicate shoaler depths, the attribute value **exposition of sounding** = 2 (shoaler than the depth of the surrounding depth area) should not be populated (see clause X.X). Where required, the shoal depths should be encoded using **Sounding**, with the appropriate underlying depth information (**Depth Contour** and **Depth Area**) to support the depths. Alternatively, the attribute **depth range maximum value** for the **Dredged Area** may be set to the designed dredged depth for the dredged area and the attribute **depth range minimum value** set to the value of the shoalest depth, or a **Caution Area** feature may be encoded covering the shoaler depth area with the depth information provided using an associated instance of the information class **Nautical Information** (see clause X.X), complex attribute **information**. Where the shoal depths are close to the edge of the dredged area, the dredged area limit may be adjusted to exclude the shoal depths from the area. See also S-4 – B-414.5.

31.2.3 Preliminary (P) Notices to Mariners (see S-4 – B-634)

1. Preliminary Notices to Mariners, (P)NMs, for paper chart are defined in S-4, Section B-600. A (P)NM promulgates navigationally significant information early to the mariner, for example when a paper chart new edition cannot be issued in due time.

For the paper chart, the convention is for the mariner to insert the Update on the chart in pencil, and erase it when the (P)NM is cancelled.

S-101 provides mechanisms which allow ENC(s) to be automatically updated (ER application profile). This allows the affected ENC(s) to be continually updated in a timely manner for the duration of the NM without additional workload for the mariner.

Producing Authorities must promulgate preliminary information which is safety-related or which otherwise needs to be advised to the mariner urgently by ENC Update to provide the ECDIS user with an updated SENC. This method of delivery corresponds to the service that (P)NMs offer to the paper chart user.

2. ER encoding for ENC and (P)NM for paper chart are two completely different communication processes for promulgating information to the mariner.

For example, there are instances when the paper chart needs updating using a NM block (also known as a chartlet or patch) or by issuing a New Edition due to the complexity or volume of changes. This could clutter the paper chart unacceptably if amended by hand and/or overburden the chart corrector. The lead time for a NM block correction or a New Edition can be lengthy, sometimes several months. In these cases a (P)NM may be issued as an interim measure. The ENC Updating mechanisms are more flexible and may allow for ENC Updates to be issued in quicker time. However, experience has shown that large Updates may result in processing issues in the ECDIS, in particular inordinately long loading times. Therefore producing an ENC New Edition may be the better option in some cases.

There may be other instances, when new information is received, where it is not possible to fully update both the ENC and paper chart promptly. For example, not all the information required to produce a chart-updating NM is received by the HO in the first notification (for instance notification of works in progress or projected), or extensive new information requires significant compilation work. In these cases it is still necessary to provide notification of navigationally significant changes to the mariner in a timely manner.

Since the paper chart and ENC processes are different (but not supposed to be independent), and also the products to which they apply are different, it is recommended that ENC Updates be derived from the source information rather than from the paper chart (P)NM. It is often the case that the paper chart (P)NM does not provide enough detail to encode the ENC Update exactly as it should be.

3. Simple or more complex encoding methods are possible but it is important for Producing Authorities to consider carefully which encoding method is appropriate when creating an ENC Update with due consideration for time.
4. Often, information received is too complex, extensive and/or imprecise to be encoded with the relevant S-101 features. In these instances the use of a **Caution Area** feature (see clause X.X) and an associated instance of the information class **Nautical Information** (see clause X.X), complex attribute **information**, sub-attribute **text** is preferred to give a précis of the overall changes together with detailed navigationally significant information. For complex or extensive changes the **Nautical Information** should have an associated **information (file reference)** referencing a file containing precise details of the preliminary information. See also clause X.X section 7 above. If the information is less precise then **information** should be used to inform mariners of this fact.

It is noted that the mariner, if it is considered necessary, has the facility in the ECDIS to add “Mariner Objects” and annotate them. These can be saved in the SENC based on information provided in textual form using the **information** complex attribute. It is envisaged that these features would be created at the “Route Planning” stage and act as a prompt during the “Route Monitoring” phase.

When information is issued as advance notification for an ENC it is necessary to provide as soon as possible to the mariner the final and full charted information encoded with the relevant S-101 features. An ENC Update or a New Edition of the ENC dataset should therefore be issued at a later date when the Producing Authority can carry out full encoding of the changes. The period of time will depend on the following:

- the time needed by the HO to undertake the full encoding with relevant features;
 - the time needed to obtain confirmation of details; and
 - the date at which the real world situation is stabilized and any forecast changes have been completed.
5. Source Information received may contain some navigationally significant elements that are simple to encode with the relevant features in a timely manner. In such cases these elements may be encoded with the relevant features provided that they reflect the “real world” situation after the ENC Update is made available to the user. However, if the changes are subject to continual change these features should be amended as a consequence and will represent additional work for the HO. In such cases, the ENC Update should also warn the mariner that the situation is subject to change. For temporary information, see clause X.X.
 6. Use of complex attribute **fixed date range**: see clause X.X section 6. For new or amended routing measures, see clause 2.6.1.1.
 7. Use of an associated instance of the information class **Nautical Information** (see clause X.X), complex attribute **information**: see clause X.X section 7.
 8. Diagrams are sometimes very useful to the mariner, for example, for indicating changes to complex routing measures or the introduction of new ones. A picture file may be referenced using an associated instance of the information class **Nautical Information** (see clause X.X), attribute **pictorial representation** in such cases.
 9. ENC Updates issued for preliminary information should be managed and reviewed regularly. For example further source information may have been acquired requiring a further ENC Update. This may add, modify or cancel information previously promulgated.
 10. Further verification is recommended to make sure that the encoded ENC Update is consistent with the corresponding paper notice.
 11. Guidelines for typical cases:
 - a) Traffic separation schemes:
 - See clause X.X. For the use of the complex attribute **fixed date range**, see also clause X.X section 6.
 - b) Complex information within an area of change (for example works in progress):
 - A **Caution Area** feature (see clause X.X) should be created to cover the area. Information is provided using an associated instance of the information class **Nautical Information** (see clause X.X), complex attribute **information**, sub-attribute **text**, for example *under*

construction, or sub-attribute **file reference** when it is necessary to give more detailed information. If sufficiently detailed information is available, then navigationally significant information such as navigational aids, fairways, regulated areas, etc. can be encoded or modified within the **Caution Area** if time permits. A reference to a picture file may also be included, if required, using the attribute **pictorial representation** on **Nautical Information**.

- Alternatively, and if considered appropriate a **Restricted Area Navigational** feature (see clause X.X), with attribute **restriction** = 7 (entry prohibited) may be encoded instead of the **Caution Area** feature.
- c) Simple information which does not need an additional notification of caution:
- The relevant feature(s) and the appropriate attributes should be encoded with any additional contextual information provided using an associated instance of the information class **Nautical Information** (see clause X.X), complex attribute **information**. In this case it is not necessary to use a **Caution Area** feature. This could apply, for example, to submarine cables or pipelines being laid (**Cable Submarine** or **Pipeline Submarine/On Land** features), or an area under reclamation (**Land Area** feature with attribute **condition** = 3 (under reclamation)). If required the encoding should reflect that positions are approximate using the spatial attribute **quality of horizontal measurement** = 4 (approximate) on the spatial type(s).
- d) Depths less than those charted within a defined area:
- If the depth values and their positions are known, **Sounding** features (see clause X.X) may be created or modified. Any affected depth contours and depth areas should also be amended as necessary. The source of the information should be encoded using an associated instance of the information class **Nautical Information** (see clause X.X), complex attribute **information**. However, Producing Authorities should carefully consider the time needed to update ENC depth information and the complexity of changes to the topology that may be required. The encoding of amended **Sounding**, **Depth Area** and associated features could be inappropriate for promulgating this navigationally significant information within acceptable time scales. In this case a **Caution Area** (see clause X.X) is the preferred option. In such cases, only the most significant amendments to depth information should be provided using an associated instance of the information class **Nautical Information**. This method should also be used if the depth values and/or the exact positions are unknown, or if the Producing Authority only has information relating to a limited number of depth values.