

Cover Image and Title text TBC

Page intentionally left blank

INTERNATIONAL HYDROGRAPHIC ORGANIZATION



FACTS ABOUT ELECTRONIC CHARTS AND CARRIAGE REQUIREMENTS

IHO Publication S-66 – Edition 2.0.0

(Publication date: June 2024)



Published by the International Hydrographic Organization

4b, Quai Antoine 1er

B.P. 445 - MC 98011 MONACO Cedex

Principauté de Monaco

Telefax: (377) 93.10.81.40

E-mail: info@iho.int

Web: <http://www.iho.int>

© Copyright International Hydrographic Organization 2024

This work is copyright. Apart from any use permitted in accordance with the Berne Convention for the Protection of Literary and Artistic Works (1886), and except in the circumstances described below, no part may be translated, reproduced by any process, adapted, communicated or commercially exploited without prior written permission from the Secretariat of the International Hydrographic Organization (IHO). Copyright in some of the material in this publication may be owned by another party and permission for the translation and/or reproduction of that material must be obtained from the owner.

This document or partial material from this document may be translated, reproduced or distributed for general information, on no more than a cost recovery basis. Copies may not be sold or distributed for profit or gain without prior written agreement of the IHO Secretariat and any other copyright holders.

In the event that this document or partial material from this document is reproduced, translated or distributed under the terms described above, the following statements are to be included:

“Material from IHO publication [reference to extract: Title, Edition] is reproduced with the permission of the IHO Secretariat (Permission No/...) acting for the International Hydrographic Organization (IHO), which does not accept responsibility for the correctness of the material as reproduced: in case of doubt, the IHO’s authentic text shall prevail. The incorporation of material sourced from IHO shall not be construed as constituting an endorsement by IHO of this product.”

“This [document/publication] is a translation of IHO [document/publication] [name]. The IHO has not checked this translation and therefore takes no responsibility for its accuracy. In case of doubt the source version of [name] in [language] should be consulted.”

The IHO Logo or other identifiers shall not be used in any derived product without prior written permission from the IHO Secretariat.

Contents

Contents	iii
Introduction.....	1
Edition Feedback.....	1
Document History	2
Abbreviations.....	3
IHO Standards	4
IHO S-52 Annex A ECDIS Presentation Library	4
IHO S-63 Data Protection Scheme	4
IHO S-64 Test Data Sets for ECDIS	4
Section 1 Regulations regarding charts	5
1.1 Regulations.....	5
1.2 IMO requirements that apply to the carriage of nautical charts	5
1.3 <i>What is a nautical chart?</i>	7
1.4 <i>What is an electronic chart display system?</i>	7
1.5 ECDIS.....	8
1.6 ECS	8
Section 2 General facts about ENCs and RNCs	9
2.1 <i>What is an electronic chart display system?</i>	9
2.2 <i>What are official charts?</i>	10
2.3 <i>What is an ENC?</i>	11
2.4 <i>How are ENCs named?</i>	11
2.5 <i>How do I recognise an ENC?</i>	12
2.5.1 When I am buying.....	12
2.5.2 When used in an ECDIS.....	12
2.6 <i>What ENCs are available?</i>	13
2.7 <i>How are ENCs protected from Unauthorised Changes?</i>	13
2.8 <i>Are there other ways that ENCs can be distributed?</i>	14
2.9 <i>What is an RNC?</i>	14
2.10 <i>How are ENCs and RNCs kept up to date?</i>	14
2.11 <i>Is it possible to check that all updates have been applied to an ENC?</i>	15

Section 3 General facts about ECDIS	15
3.1 A closer look at ECDIS	15
3.2 How is an ECDIS approved and by whom?.....	16
3.3 <i>Is there a need to keep ECDIS software updated?</i>	16
3.4 <i>Is there a mandatory requirement to carry ECDIS?</i>	16
3.5 Meeting Carriage Requirements with ECDIS	17
3.6 Back-up Requirements	17
3.7 <i>What to do in areas without ENC coverage?</i>	18
3.8 <i>Does your ECDIS system meet IMO chart carriage requirements?</i>	19
3.9 <i>Can chart format names indicate carriage compliance?</i>	19
Section 4 ECDIS and Port State control	21
4.1 Acceptance of ECDIS by Port State Control Authorities.....	21
4.2 IHO Advice for PSC Inspectors Concerning IHO Standards	21
Section 5 Operational use of ECDIS and electronic charts	26
5.1 Is there a need for ECDIS training?.....	26
5.2 <i>What are the requirements for ECDIS training?</i>	27
5.3 <i>What are the operational considerations when using ECDIS?</i>	28
5.4 Voyage Planning.....	28
5.5 Voyage execution.....	28
5.6 Over reliance on ECDIS	29
5.7 More on ECS	29
5.8 Technical Details of Electronic Charts	29
5.8.1 Official Electronic Chart Data	29
5.9 Types of Official Chart Data.....	29
5.10 Electronic Navigational Charts (ENCs).....	30
5.10.1 General Principles	30
5.11 ENC Data Format	30
5.12 ENC Display	30
5.13 <i>What scale should an ENC be displayed at?</i>	34
5.14 ENC Compilation Scale	35
5.14 Effect of over-scaling	36
5.15 ENC over-scaling	37
5.16 Conclusions and recommendations.....	39
5.17 Dangerous effects of over-scale ECDIS Display near ‘Isolated dangers’	40
Section 6 Accuracy of depth information in Electronic Navigational Charts	41
6.1 Generalized information.....	43
6.2 High accuracy depth information	45

6.3 Medium accuracy depth information.....	45
6.4 Poor accuracy depth information.....	45
6.5 Quality descriptions of individual objects dangerous to safe navigation.....	45
6.6 Survey reliability.....	46
6.7 Depth accuracy in relation to charted depth.....	49
6.8 ECDIS safety checking function.....	50
6.9 Safety contour.....	54
6.10 Zones of Confidence symbols in ENC.....	54
6.11 Impact of ZOC categories upon mariners.....	55
Section 7 Distribution of ENCs and RNCs.....	56
7.1 Updating ENCs.....	56
7.2 ENC Distribution.....	56
7.3 <i>What is a SENC?</i>	57
7.4 SENC Delivery.....	57
7.5 Official and Unofficial Data.....	57
7.6 Use of ENCs in ECS.....	57
7.7 Raster Navigational Charts (RNCs).....	57
7.8 RNC data format and production.....	58
7.9 RNC Display.....	58
7.10 RNC updating.....	60
7.11 Private Chart Data.....	60
Section 8 IHO ECDIS & ENC cyber security.....	61
8.1 Introduction.....	61
8.2 Glossary of terms.....	61
8.3 References.....	61
8.4 Guideline objectives.....	62
8.5 Scope of applicability.....	62
8.6 Transferring ENC data and cell permits via removable media.....	63
8.7 Identifying threats via removable media.....	63
8.7.1 USB/DVD.....	63
8.7.2 ECDIS.....	63
8.7.3 Communication/back-of-bridge system.....	63
8.7.4 Vessel network.....	64
8.7.5 Potential threat actors.....	64
8.7.6 Lack of cyber security training and awareness.....	64
8.7.7 Identifying vulnerabilities.....	64
8.7.8 Transferring data and permits to ECDIS via USB/DVD.....	64
8.7.9 ECDIS operating system.....	64
8.7.10 Outdated or lack of antivirus on ECDIS.....	65

8.8 Identifying threats to your network	67
8.9 Protect	68
8.10 Detect	68
8.11 Respond	69
8.12 Recover	69
Section 9 ECDIS Training	75
9.1 IMO ECDIS training requirements	76
9.2 STCW.7/Circ.24 6 February 2017	77
Section 10 Training Objectives	78
Section 11 IMO Model Training Course - <i>Operational Use of ECDIS</i>	79
Section 12 Certification of ECDIS Education	80
ANNEX A: Zones of Confidence Categories	81
ANNEX B: Assessment of the quality of a survey into a Zone of Confidence by the Hydrographic Office	83
Assessment examples	83
Position accuracy of a survey	85
ANNEX C: References and Further Reading	87

Introduction

The International Convention for the Safety of Life at Sea (SOLAS) includes a requirement for all ships to carry up-to-date nautical charts and publications for the intended voyage. Progressively from 2012, the chart carriage requirement for certain classes of vessels is to be satisfied by electronic means using an Electronic Chart Display and Information System (ECDIS).

Feedback from those involved in the use of charts and electronic chart systems including manufacturers, distributors, users, ship owners, regulatory authorities, pilots, harbour authorities and others indicates a requirement to provide guidance on the regulations and the status of equipment that is available in the market today. In particular the differences between the various types of equipment and the differences between the various types of chart data offered to users are unclear with respect to the regulations in place.

This document has been produced to help clarify some of the uncertainties. It is not intended to replace or amend national or international rules and regulations. Readers should always refer to the relevant national administration or Flag State for the latest detailed information.

This document also contains useful information for the mariner describing how to evaluate the quality of the depth information in an ENC and how to take that information into account in the best possible way to execute safe navigation.

This document consists of a number of interrelated sections. This first section contains information on various aspects of electronic charts and electronic chart display system. The main emphasis is on what can be used to satisfy the SOLAS carriage requirements for charts.

Section 1: Regulations regarding charts

Section 2: General facts about ENCs and RNCs

Section 3: General facts about ECDIS

Section 4: ECDIS and Port State control

Section 5: Operational use of ECDIS and electronic charts

Section 6: Accuracy of depth information in Electronic Navigational Charts

Section 7: Distribution of ENCs and RNCs

Section 8: IHO ECDIS & ENC cyber security

This document may be downloaded from the IHO website at <http://www.iho.int>

Links to pages on the IHO web site containing related documents can be found in the [References](#) section.

Edition Feedback

Feedback from readers on any aspect of the document is welcome.

Send feedback to: info@iho.int or:

Organisation Hydrographique Internationale
4b, Quai Antoine 1er
B.P. 445
MC 98011 MONACO CEDEX
PRINCIPAUTE DE MONACO

Document History

This document was originally produced by Hydrographic Offices from the two Regional ENC Coordination Centres (RENCs), PRIMAR and IC-ENC. In 2008 a 2nd edition of the publication, produced by the PRIMAR and IC-ENC Joint Information Working Group (JIWG), was adopted by the IHO. Following further revision it was published in January 2010 as IHO publication S-66. Edition 1.1.0 has been prepared by the IHO ENC Standards Maintenance Working Group (ENCWG) in order to correct and update content that has changed since Edition 1.0.0.

In 2020, S-67 (Mariners Guide to Accuracy of Depth Information in an ENC) was finalised and published by the IHO Data Quality Working Group. This publication was created to provide mariners with guidance on how to consider the quality of depth data when using an ENC for navigation.

In edition 2 of this document, the publication S-67 has been included so that all guidance for mariners is gathered in one document. This edition also includes the new IHO Cyber security guidelines.

Abbreviations

Abbreviation	Explanation
AIS	Automatic Identification System
ARPA	Automatic Radar Plotting Aid
BIMCO	Baltic and International Maritime Council
BSB	Raster data format used by USA and Canada and others (BSB comes from the first letter of the companies that joined together with NOAA to make the first NOAA raster charts: Better Boating Association, Sewall Company and Blue Marble Geographics)
CATZOC	Category of Zone of Confidence
ECDIS	Electronic Chart Display and Information System
ECS	Electronic Chart System (does not meet SOLAS requirements)
ECS charts	Non official (private) chart data (vector or raster)
ENC	Electronic Navigational Chart
GNSS	Global Navigation Satellite System
GPS	Global Positioning System
HCRF	Hydrographic Chart Raster Format
HO	Hydrographic Office
IC-ENC	International Centre for ENC's, a RENC operated by the UK Hydrographic Service
IEC	International Electrotechnical Commission
IHO	International Hydrographic Organization
IMO	International Maritime Organization
ISM	International Safety Management code
ISO	International Organization for Standardization
m	Metre
MED	Maritime Equipment Directive of the European Union
NM	Nautical Mile
PRIMAR	a RENC operated by the Norwegian Hydrographic Service
PSC	Port State Control
PSCO	Port State Control Officer
RCDS	Raster Chart Display System
RENC	Regional ENC Coordination Centre
RNC	Raster Navigational Chart
RTCM	Radio Technical Commission for Maritime Services
SATCOM	Satellite Communications
SENC	System ENC
SOLAS	International Convention for the Safety of Life at Sea
STCW	Standards of Training, Certification and Watch-keeping
WEND	World-wide ENC Database
WGS 84	World Geodetic System 1984
ZOC	Zone of Confidence

IHO Standards

The International Hydrographic Organization (IHO) is the intergovernmental organization responsible for developing international standards related to hydrographic services as defined in SOLAS regulation V/9. Under its remit, and in support of the relevant performance standards for ECDIS adopted by the International Maritime Organization (IMO), the IHO maintains the following set of standards related to ECDIS:

- S-57 - Transfer Standard for Digital Hydrographic Data (including the Product Specification for Electronic Navigational Chart (ENC));
- S-52 - Chart Content and Display Aspects of ECDIS;
- S-52 - Annex A – ECDIS Presentation Library (Preslib);
- S-64 - Test Data Sets for ECDIS;
- S-58 - ENC Validation Checks;
- S-61 - Product Specification for Raster Navigational Chart (RNC);
- S-62 - Data Producer Codes;
- S-63 - Data Protection Scheme;
- S-65 - ENCs: Production, Maintenance and Distribution Guidance;
- S-11 - Part A – Guidance for the Preparation and Maintenance of International (INT) Chart and ENC Schemes.

As a consequence of the investigations into the anomalous operation of some ECDIS, the IHO undertook in 2012 a review of its standards related to ECDIS. The review revealed that certain parts of the requirements of the IHO ECDIS-related standards had been interpreted and implemented in different ways by different manufacturers. The investigations made it clear that there were a number of improvements that should be made to reduce the risk of implementation irregularities in the future and improve the clarity of the standards. Feedback from ships at sea also indicated that there were a number of display enhancements that would significantly increase the usability of ENC in ECDIS.

This review led to the development of three new editions of the following IHO ECDIS related standards:

IHO S-52 Annex A ECDIS Presentation Library

This standard controls the graphical display of the ENC in ECDIS, from the symbols and line styles that must be used to depict features right through to the colours that govern the day, dusk and night modes. This standard has been extensively updated to address excessive alarms and other ECDIS related display anomalies. A summary of the main changes introduced in IHO ECDIS Presentation Library (PresLib) Edition 4.0 is included at Annex A of this document.

IHO S-63 Data Protection Scheme

This standard protects against data piracy by encrypting the ENC information. It also provides a mechanism for mariners to licence ENCs from data providers; and provides authentication assurance that the ENC data being loaded into the ECDIS has come from an approved source. It has been updated to include a new Annex specifying how to implement an ENC update status report.

IHO S-64 Test Data Sets for ECDIS

This standard contains sets of ENCs and RNCs designed specifically to support ECDIS manufacturers taking systems through the process of type approval against IEC Standard 61174. It has been updated with new test data sets to ensure the presentation of ENC features displayed in ECDIS is correct.

Section 1 Regulations regarding charts

1.1 Regulations

The International Maritime Organization (IMO) is the United Nations organization that is concerned with maritime transportation. The 1974 Convention for the Safety of Life at Sea (SOLAS), together with subsequent amendments, has been adopted by the Member States of the IMO. Chapter V of SOLAS specifies the requirements for the navigational equipment to be used on board ships entitled to fly the flag of a party to the SOLAS Convention.

IMO Member States are obliged to adopt IMO rules and regulations, such as those in SOLAS, into their national legislation. However, only when the requirements of the Convention have been incorporated into national legislation do they take effect for the individual ships registered by that State. The process of incorporation into national legislation may vary from a few months to several years.

The State in which a ship is registered and hence the flag it is flying is known as the Flag State. It is the national maritime administration representing the Flag State that controls the ship's adherence to the SOLAS carriage requirements (Flag State control).

The national maritime administration is also responsible for Port State control. Ships arriving at a port may be subject to Port State control by local officers (PSCO). Port State control is based on Flag State regulations and international agreements. Port States cooperate within regions to apply consistent standards; for example, the European nations and Canada cooperate under the umbrella of the Paris Memorandum of Understanding (Paris MOU).

1.2 IMO requirements that apply to the carriage of nautical charts

IMO SOLAS V/2 1974 (as amended):

*2.2 Nautical chart or nautical publication is a special-purpose map or book, or a specially compiled database from which such a map or book is derived, that is issued officially by or on the authority of a Government, authorized Hydrographic Office or other relevant government institution and is designed to meet the requirements of marine navigation.**

Footnote to regulation 2.2

** Refer to appropriate resolutions and recommendations of the International Hydrographic Organization concerning the authority and responsibilities of coastal States in the provision of charting in accordance with regulation 9.*

IMO SOLAS V/19 1974 (as amended):

19.2.1 All ships irrespective of size shall have:

19.2.1.4 nautical charts and nautical publications to plan and display the ship's route for the intended voyage and to plot and monitor positions throughout the voyage. An electronic chart display and information system (ECDIS) is also accepted as meeting the chart carriage requirements of this subparagraph. Ships to which paragraph [2.10] applies shall comply with the carriage requirements for ECDIS detailed therein;

19.2.1.5 back-up arrangements to meet the functional requirements of subparagraph 2.1.4, if this function is partly or fully fulfilled by electronic means;*

Footnote to regulation 19.2.1.5

** An appropriate folio of paper nautical charts may be used as a back-up arrangement for ECDIS. Other back-up arrangements for ECDIS are acceptable (see Appendix 6 to resolution A.817(19), as amended).*

IMO SOLAS V/27 (as amended):

Nautical charts and nautical publications, such as sailing directions, lists of lights, notices to mariners, tide tables and all other nautical publications necessary for the intended voyage, shall be adequate and up to date.

The three regulations referred to above show that depending on the class of vessel, the carriage requirement for charts can be fulfilled by:

- Carriage of official and up to date paper charts; or
- Carriage of a type-approved ECDIS (in accordance with the requirements of the IMO ECDIS Performance Standards) supplemented by an appropriate back-up arrangement, and up to date Electronic Navigational Charts (ENC).

SOLAS Chapter V Regulation 18

*4. Systems and equipment installed prior to the adoption of performance standards by the Organization may subsequently be exempted from full compliance with such standards at the discretion of the Administration, having due regard to the recommended criteria adopted by the Organization. However, for an electronic chart display and information system (ECDIS) to be accepted as satisfying the chart carriage requirement of regulation 19.2.1.4, that system shall conform to the relevant performance standards not inferior to those adopted by the Organization in effect on the date of installation, or, for systems installed before 1 January 1999, not inferior to the performance standards adopted by the Organization on 23 November 1995 **.*

*** Recommendation on Performance Standards for Electronic Chart Display and Information Systems (ECDIS) (resolution A.817(19)).*

SOLAS Chapter V Regulation 19

2. Shipborne navigational equipment and systems

2.1 All ships irrespective of size shall have:

2.1.4 nautical charts and nautical publications to plan and display the ship's route for the intended voyage and to plot and monitor positions throughout the voyage. An electronic chart display and information system (ECDIS) is also accepted as meeting the chart carriage requirements of this subparagraph. Ships to which paragraph 2.10 applies shall comply with the carriage requirements for ECDIS detailed therein;

*2.1.5 back-up arrangements to meet the functional requirements of subparagraph .4, if this function is partly or fully fulfilled by electronic means;**

** An appropriate folio of paper nautical charts may be used as a back-up arrangement for ECDIS. Other back-up arrangements for ECDIS are acceptable (see appendix 6 to resolution A.817(19), as amended).*

SOLAS Chapter V Regulation 27

Nautical charts and nautical publications, such as sailing directions, lists of lights, notices to mariners, tide tables and all other nautical publications necessary for the intended voyage, shall be adequate and up to date.

MSC.1/Circ.1503 (as amended) ECDIS – Guidance for Good Practice

The mandatory carriage of ECDIS, as required by SOLAS regulation V/19.2.10, was subject to a staged entry into force between 1 July 2012 and 1 July 2018. As per SOLAS regulations V/18 and V/19, for a ship to use ECDIS to meet the chart carriage requirements of SOLAS, the ECDIS equipment must conform to the relevant IMO performance standards. ECDIS units on board are required to comply with one of two performance standards (either IMO resolution A.817(19), as amended; or resolution MSC.232(82)), depending on the date of their installation.

Essentially, where an ECDIS is being used to meet the chart carriage requirements of SOLAS, it must:

- i. be type-approved;
- ii. use up to date electronic navigational charts (ENC);
- iii. be maintained so as to be compatible with the latest applicable International Hydrographic Organization (IHO) standards; and
- iv. have adequate, independent back-up arrangements in place.

IMO MSC.1/Circ.1503 (as amended) states, 'ECDIS that is not updated to the latest version of the IHO Standards may not meet the chart carriage requirements as set out in SOLAS regulation V/19.2.1.4'.

The changes introduced in the latest versions of the IHO standards will assist Port State control (PSC) inspectors in determining if a vessel is complying with the regulations from SOLAS Chapter V. The IHO maintains a list of the current IHO standards in force on its website – <https://iho.int/en/standards-in-force> (English); and <https://iho.int/fr/normes-en-vigueur> (French). The ENCs (and any RNCs) used for the intended voyage are up to date; and

- There are approved back-up arrangements available to ensure a safe transfer of the ECDIS functions in the event of an ECDIS failure and to provide safe navigation for the remaining part of the voyage.

1.3 What is a nautical chart?

Nautical charts are special purpose maps specifically designed to meet the requirements of marine navigation, showing amongst other things depths, nature of the seabed, elevations, configuration and characteristics of the coast, dangers, routes, maritime limits, and aids to navigation.

Nautical charts provide a graphical representation of relevant information to mariners for planning and executing safe navigation.

Nautical charts are available in analogue form as paper charts, or digitally as electronic charts.

The requirements for the carriage of nautical charts are laid down in SOLAS Chapter V.

The relevant regulations are:

- Regulation 2, which defines the nautical chart;
- Regulation 19, which specifies the equipment (including charts) to be carried on different types of ships; and
- Regulation 27, which specifies the requirement to keep charts and publications up to date.

1.4 What is an electronic chart display system?

An electronic chart display system is a general term for a configuration of electronic equipment, software, and nautical chart data that is capable of displaying a vessel's position superimposed on a chart image.

There are two classes of electronic chart display systems. The first is an ECDIS (Electronic Chart Display and Information System), which can meet IMO/SOLAS chart carriage requirements. The second is an ECS (Electronic Chart System), which can be used to assist navigation, but does not meet IMO/SOLAS chart carriage requirements.

1.5 ECDIS

ECDIS equipment is specified in the IMO ECDIS Performance Standard (see Resolution MSC.232(82)) as follows:

Electronic Chart Display and Information System (ECDIS) means a navigation information system which with adequate back-up arrangements can be accepted as complying with the up-to-date chart required by regulations V/19 and V/27 of the 1974 SOLAS Convention, as amended, by displaying selected information from a system electronic navigational chart (SENC) with positional information from navigation sensors to assist the mariner in route planning and route monitoring, and if required display additional navigation-related information.

Where the term ECDIS is used in this document, it means those navigational electronic chart systems, that have been tested, approved and certified as compliant with the IMO ECDIS Performance Standard and other relevant IMO Performance Standards and thus are compliant with the ECDIS chart carriage requirements contained in SOLAS Chapter V.

The IMO MSC.1/Circ.1503 (as amended) Circular on “*ECDIS - Guidance for Good Practice*”, adopted at MSC 95 in June 2015, provides useful references on ECDIS matters.

1.6 ECS

ECS is specified in ISO 19379:2003¹ as follows:

ECS is a navigation information system that electronically displays vessel position and relevant nautical chart data and information from an ECS Database on a display screen, but does not meet all the IMO requirements for ECDIS and is not intended to satisfy the SOLAS Chapter V requirements to carry a navigational chart.

ECS equipment ranges from simple hand held GPS enabled devices to sophisticated stand-alone computer equipment interfaced to ship systems.

¹ See http://www.iso.org/iso/catalogue_detail.htm?csnumber=33801

Section 2 General facts about ENC and RNCs

2.1 What is an electronic chart display system?

There are two types of electronic chart – raster charts and vector charts. A raster chart is a scanned and passive image of a paper chart, whereas a vector chart is a digital database of all the objects (points, lines, areas, etc.) represented on a chart. See Section 4 for further technical details.

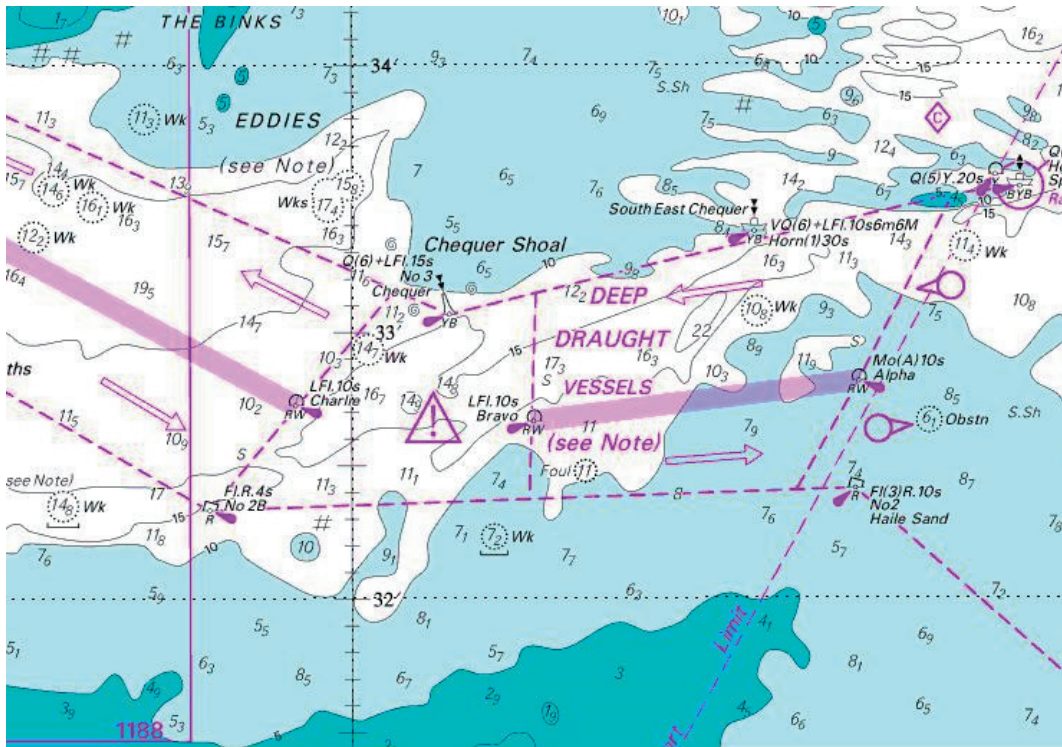

Example of a raster chart

2.2 What are official charts?

According to SOLAS V (see Section 1.2), charts issued by or on the authority of a Government, authorized Hydrographic Office or other relevant government institutions are official and may be used to fulfil carriage requirements (provided they are kept up to date).

All other nautical charts are by definition not official and are often referred to as unofficial or private charts. These charts are not accepted as the basis for navigation under the SOLAS Convention.

There are two kinds of official digital nautical charts commonly available; Electronic Navigational Charts (ENC) and Raster Navigational Charts (RNC). The inner construction of ENCs and RNCs is fundamentally different:

- ENCs are vector charts, and
- RNCs are raster charts



Example of a vector chart with vessel's position in the centre

2.3 What is an ENC?

IMO's definition for the Electronic Navigational Chart – ENC:

Electronic Navigational Chart (ENC) means the database, standardized as to content, structure and format, issued for use with ECDIS by or on the authority of a Government, authorized Hydrographic Office or other relevant government institution, and conform to IHO standards. The ENC contains all the chart information useful for safe navigation and may contain supplementary information in addition to that contained in the paper chart (e.g. sailing directions), which may be considered necessary for safe navigation.

An ENC is a vector chart comprising a collection of geo-referenced objects (Datum: WGS 84). If properly used with ECDIS (which examine continuously vessel's position and movements), ENC can be displayed as a seamless chart-like display at user-selected scales providing real-time warnings of impending dangers.

ENCs are updated with periodically official updates that are normally distributed digitally by Hydrographic Offices. Any other vector chart data is unofficial and therefore does not meet the SOLAS chart carriage requirements.

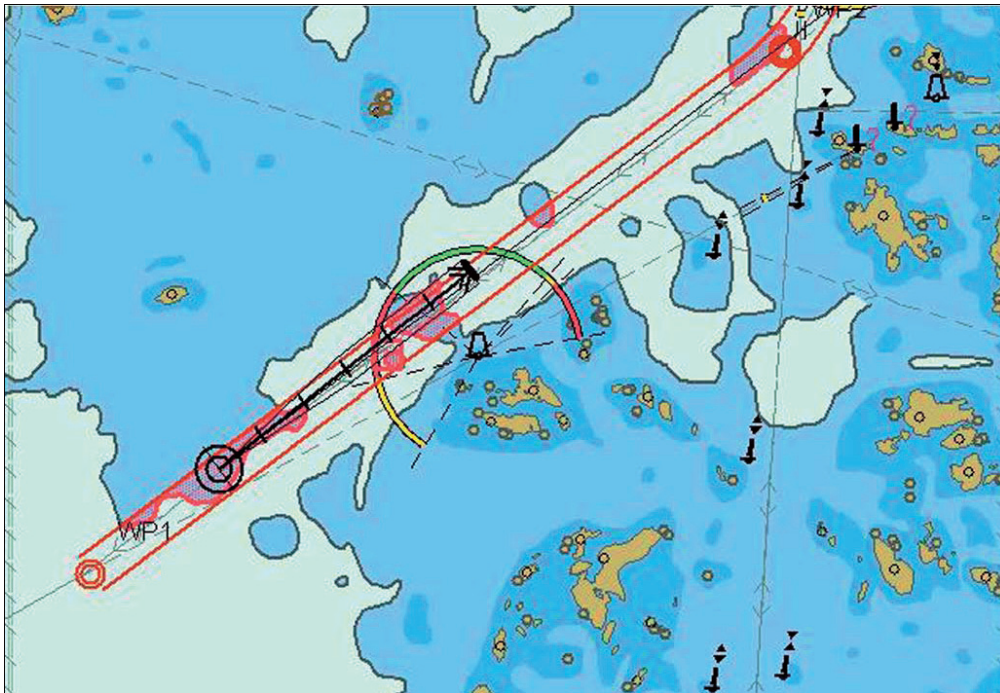

ENC data displayed on an ECDIS

2.4 How are ENCs named?

Each ENC is identified by an 8-character identifier, for example FR501050. The first two characters indicate the producer; for example FR for France, GB for United Kingdom of Great Britain and Northern Island. A complete list of producer codes is included in the IHO standard S-62 – “*List of Data Producer Codes*”. The third character (a number from 1 to 6) indicates the Navigational Purpose (indicates the Navigational Purpose (see clause 5.13)). The last five characters are alpha-numeric free text and provide a unique identifier.

2.5 How do I recognise an ENC?

2.5.1 When I am buying

Only authorized user service providers and their distributors sell ENCs, generally under licence agreement; and the delivery of ENC Update information (the equivalent to the Notices to Mariners system for paper charts) is an essential part of their services. These user service providers are appointed either directly by the originating Hydrographic Office or by a Regional ENC Coordinating Centre (RENC) acting on behalf of its participating Hydrographic Offices.

Some national Hydrographic Offices distribute their ENCs directly to end-users. Where this occurs, ENCs (including Updates) must be downloaded from the Hydrographic Office's official website.

2.5.2 When used in an ECDIS

An ECDIS distinguishes ENC data from unofficial data. When unofficial data is used, ECDIS provides mariners with a continuous warning on the screen that they must navigate by means of an official, up to date ENC, RNC or paper chart.

If unofficial data is displayed on ECDIS, its boundaries are identified by a special line style - a "one-sided" RED line with the diagonal stroke on the side of the line containing the unofficial data.

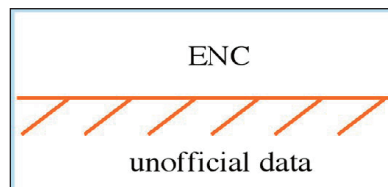

Boundary between ENC and unofficial data as displayed by ECDIS

The mariner can also select the appropriate ECDIS function that interrogates the chart display to obtain the chart details, such as information on the data originator, edition number and status of updating.

2.6 What ENC's are available?

In addition to RENC and national on-line catalogues, the International Hydrographic Organization (IHO) provides an interactive ENC Coverage Catalogue at <https://iho.int/en/iho-online-catalogues> that shows the availability status of ENC's worldwide.

The illustration below shows the front page of the catalogue:

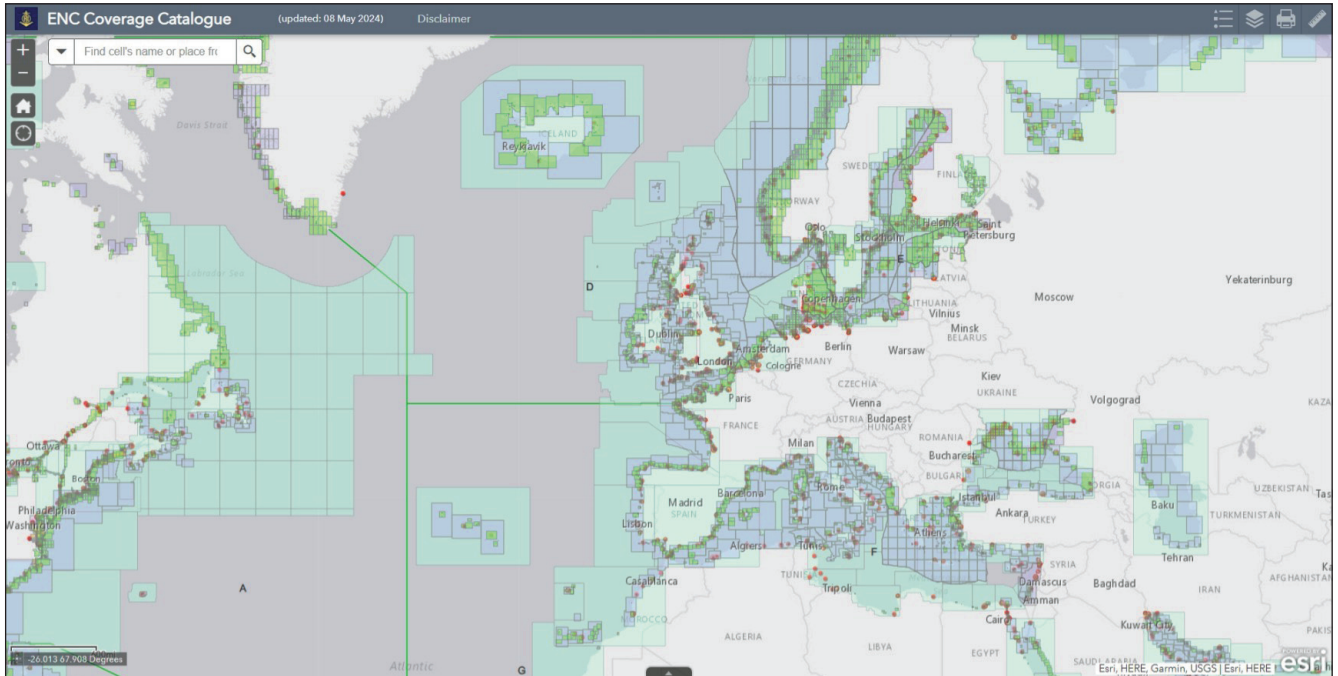

IHO online catalogue for coverage and availability of ENC

2.7 How are ENC's protected from Unauthorised Changes?

The majority of ENC's are made available to the end-users in a protected form using the IHO S-63 ENC data protection scheme. S-63 protection ensures the integrity of the ENC data in all transactions between the service provider and the end-user. The protection scheme enables an ECDIS to confirm the authenticity of the supplied information.

S-63 defines the mechanism for encrypting ENC information and applying a digital signature to enable authentication of the chart data by an ECDIS. ECDIS users require an individual decryption key to access and view the ENC data protected by the S-63 scheme. Each ENC cell is encrypted with a different key. The decryption keys are provided to the end-user as 'Cell Permits' by ENC service providers. Decryption keys are unique and apply to specific end-user systems. As a consequence, they cannot be exchanged or shared between different ECDIS installations.

The operation of the ENC protection scheme should not add any operational overhead for ECDIS users. All aspects of ENC decryption and authentication should be handled automatically by the chart system. An ECDIS user will occasionally receive new Cell Permits from their service provider when their ENC subscription is renewed or there are changes to the ENC chart outfit. The updated Cell Permits must be imported into the ECDIS to enable it to automatically process new ENC deliveries and updates.

A few national Hydrographic Offices distribute their ENC's without using encryption. All ECDIS are able to access and display these unencrypted ENC's.

2.8 Are there other ways that ENC's can be distributed?

As well as distributing ENC's in the IHO S-57 format, the IHO has approved the distribution of ENC's in the internal "machine-formats" of individual ECDIS manufacturers. The generic name for this form of distribution is SENC distribution (System-ENC distribution). SENC distribution can improve the speed of loading ENC-data in some ECDIS equipment. The IHO requirements are that service providers offering SENC-distribution must have the agreement of the producer Hydrographic Office of the ENC's, and must also use type approved processes to ensure that the integrity of the S-57 format ENC data is maintained during the conversion to a SENC format.

2.9 What is an RNC?

RNC means "Raster Navigational Chart". RNC's are digital raster copies of official paper charts. RNC's conform to IHO Product Specification S-61. In accordance with the SOLAS V definition of a nautical chart, RNC's can only be issued *by, or on the authority of, a Government, authorized Hydrographic Office or other relevant government institution*.

RNC's have the following attributes:

- RNC's are a facsimile of official paper charts;
- RNC's are produced according to the international standards set by the IHO;
- RNC's are regularly updated with official update information. This is distributed digitally.

The IMO ECDIS Performance Standard states that where ENC's are not available, RNC's may be used in ECDIS to meet the chart carriage requirements. However, when an ECDIS is being used with RNC's, the RNC's should be used together with "*an appropriate folio of up to date paper charts*". See section "Meeting carriage requirements with ECDIS".

The option to use RNC's in ECDIS will steadily reduce as more and more ENC's become available.

RNC's, when used in ECDIS do not provide the same level of functionality that is provided by ENC's. The limitations of operating with RNC's are outlined in Appendix 2 of IMO MSC.1/Circ.1503 (as amended) *ECDIS – Guidance for Good Practice*. Guidance on chart datum's and the accuracy of positions is provided in IMO SN.1/Circ 255.

2.10 How are ENC's and RNC's kept up to date?

In order to meet the requirements of SOLAS V/27, nautical charts must be kept up to date by incorporating Notices to Mariners and other chart updates issued by Hydrographic Offices. (See Stage 9 in IHO S-65 - *ENC's: Production, Maintenance and Distribution Guidance*).

ENC's and RNC's are normally kept up to date by applying regular update information to the chart data via a digital data file. The update file may be transferred by wireless transmission, or on a suitable media, such as a CD-ROM. In these cases the updating of the chart database is done automatically by the ECDIS. Another standard function of ECDIS is the capability to update the ENC manually. This may be required when a digital update is not available or a hydrographic office has issued update information in a non-digital form.

ENC and RNC updates are generally supplied to ships by 'remote updating' using satellite (or, when in port, shore based) telecommunications, or on CD-ROM. Most ENC service providers now also provide updating services using e-mail, the worldwide web and other remote means. Details may be obtained from ENC distributors.

2.11 *Is it possible to check that all updates have been applied to an ENC?*

Updates to ENCs are sequential. The sequence is unique to each ENC. During the updating process ECDIS always checks that all updates in the sequence have been applied. If an update is missing then the ECDIS will indicate this. It is not possible to load later updates until any earlier updates have been applied.

An ECDIS maintains an internal list of the updates that have been applied and the date of their application. The format and content of an “ENC Update Status Report” is specified in Annex C of IHO standard S-63 “*IHO Data Protection Scheme*”. Such a status report is designed to demonstrate the revision status of ENCs within the ECDIS SENC, and can be generated by the ECDIS user. Some ENC service providers (for example RENCs) also provide additional tools to generate reports on the “up-to-datedness” of the ENCs in the SENC. ENC distributors should be able to provide mariners with details of the latest ENC edition and update numbers in force. It is also possible to refer to traditional sources of update information, such as Notices to Mariners for paper charts, to cross-check and verify that corresponding ENC updates have been applied.

Port State Control officers are likely to refer to the update status report function of ECDIS to verify that ENCs are being kept up to date in accordance with SOLAS V Regulation 27.

Section 3 General facts about ECDIS

3.1 A closer look at ECDIS

ECDIS equipment is specified in the IMO ECDIS Performance Standards (IMO Resolution MSC.232 (82)) as follows:

Electronic Chart Display and Information System (ECDIS) means a navigation information system which, with adequate back up arrangements, can be accepted as complying with the up-to-date chart required by regulation V/19 & V/27 of the 1974 SOLAS Convention, as amended, by displaying selected information from a system electronic navigational chart (SENC) with positional information from navigation sensors to assist the mariner in route planning and route monitoring, and if required display additional navigation-related information.

ECDIS is a ship borne navigational device and as such the rules governing its use come under the jurisdiction of the IMO through SOLAS. The IMO has adopted performance standards for ECDIS (IMO Resolution MSC.232 (82) and subsequent amendments). ECDIS equipment must be certified as meeting these performance standards if it is to be used to meet the chart carriage requirements of SOLAS V/19. Certification of ECDIS equipment is achieved through type-testing and certification.

Within an ECDIS, the ENC database contains chart information in the form of geographic objects represented by point, line and area shapes, carrying individual attributes. Appropriate mechanisms are built into the ECDIS to query the data, and then to use the information to perform various navigational and monitoring functions (such as, anti-grounding surveillance) and to generate a chart-like display.

The presentation of ENC data on a screen display is specified in IHO standard S-52 “*Specification for Chart Content and Display Aspects of ECDIS*”. The style of presentation defined in S-52 is mandatory.

3.2 How is an ECDIS approved and by whom?

To meet SOLAS requirements an ECDIS must be certified to show it conforms to the IMO Performance Standard for ECDIS. This is achieved through the type approval and certification processes recognised by the relevant Flag State.

Type approval is normally conducted by recognized technical organizations or by marine classification societies approved by Flag States. However in some countries the maritime administration conducts type approval themselves. Many European governments have agreed to mutual recognition of their ECDIS type approval certificates – indicated by the so-called “Wheel Mark” sign which indicates conformity with the Maritime Equipment Directive of the European Union (MED).

ECDIS type approval testing is conducted using test standards and procedures developed by the International Electro-technical Commission (IEC). These are based on the IMO Performance Standard for ECDIS and the supporting IHO standards (IHO S-52, S-57, S-63, S-64). The S-64 “*IHO Test Data Sets for ECDIS*” is used for type approval testing (not for mariners), and the IEC testing standard for ECDIS is IEC 61174 (See: www.iho.int > ENC & ECDIS > [Information on IHO Standards related to ENC and ECDIS](#)).

3.3 Is there a need to keep ECDIS software updated?

If ECDIS software is not upgraded to read ENCs based on the latest version of the S-57 ENC Product Specification or to use the latest version of the S-52 Presentation Library then the ECDIS may be unable to correctly display the latest approved chart symbols. If an ECDIS is unable to interpret and draw any newly introduced chart symbol it will display a question mark (?) instead. Additionally there will be a possibility that alarms and indications for any newly introduced features may not be activated even though they have been included in the ENC. Because of this, the IMO have issued guidance on the maintenance of ECDIS software in IMO MSC.1/Circ.1503 (as amended) *ECDIS – Guidance for Good Practice*.

ECDIS users should ensure that their ECDIS software always conforms to the latest IHO standards. This should be available from the “*about*” function in the software or from the ECDIS manufacturer. A list of the current IHO standards relevant to ECDIS software is maintained in the ENC/ECDIS section of the IHO website (See www.iho.int > ENC & ECDIS > [Current ENC and ECDIS Standards](#)).

3.4 Is there a mandatory requirement to carry ECDIS?

In July 2002 an amendment to Chapter V of SOLAS came into force. This amendment included a specific reference to ECDIS and stated that it

... may be used to fulfil the chart carriage requirements of Regulation 19.

A further amendment to Regulation 19 adopted in June 2009 requires that certain classes of vessel use ECDIS to meet the SOLAS V chart carriage requirements in table 3-1:

Ship type	Size	New ships	Existing ships
Passenger ships	>= 500 GT	constructed on or after 1 July 2012	constructed before 1 July 2012: not later than the first survey* on or after 1 July 2014
Tankers	>= 3000 GT	constructed on or after 1 July 2012	constructed before 1 July 2012: not later than the first survey* on or after 1 July 2015

Ship type	Size	New ships	Existing ships
Cargo ships, other than tankers	>= 10 000 GT	constructed on or after 1 July 2013	see below
	>= 3000 < 10 000 GT	constructed on or after 1 July 2014	-
	>= 50 000 GT	-	constructed before 1 July 2013: not later than the first survey* on or after 1 July 2016
	>= 20 000 < 50 000 GT	-	constructed before 1 July 2013: not later than the first survey* on or after 1 July 2017
	>= 10 000 < 20 000 GT	-	constructed before 1 July 2013: not later than the first survey* on or after 1 July 2018
*Refer to the Unified interpretation of the term "first survey" referred to in SOLAS regulations (MSC.1/Circ.1290).			

Table 3-1

Flag State authorities may exempt ships from the requirements shown in table 3-1 if those ships will be taken permanently out of service within two years after the implementation dates shown for other ships of the same class.

In addition to SOLAS V/19, ECDIS has already been fixed as the chart carriage requirement in the High Speed Craft Code of IMO (HSC). In December 2006 the 82nd session of the Marine Safety Committee (MSC82) agreed amendments to 1994 and 2000 HSC Code with regard to ECDIS:

... *High-speed craft shall be fitted with an ECDIS:*

New vessels	Existing vessels
Craft constructed on or after 1 July 2008	Craft constructed before 1 July 2008, not later than 1 July 2010.

3.5 Meeting Carriage Requirements with ECDIS

Only a type-approved ECDIS operating with up to date ENC's and with appropriate back-up arrangements may be used to replace paper chart navigation. Where ENC's are not available, the SOLAS regulations allow Flag States to authorise the use of RNC's (together with an appropriate folio of paper charts) - See Section 3.6. In all other cases the vessel must carry all the paper charts necessary for its intended voyage.

3.6 Back-up Requirements

No electronic system can be completely failsafe. The IMO Performance Standard for ECDIS therefore requires that the "overall system" includes both a primary ECDIS and an adequate, independent back-up arrangement that provides:

- *Independent facilities enabling a safe take over of the ECDIS functions in order to ensure that a system failure does not result in a critical situation;* and
- *A means to provide for safe navigation for the remaining part of the voyage in case of ECDIS failure.*

However, these rather basic statements allow for considerable flexibility. This means that there can be various interpretations as to what are the minimum functional requirements, or what constitutes "adequate" back-up arrangements.

There are two commonly accepted options:

- A second ECDIS, connected to an independent power supply and a separate GNSS position input;
- Up to date paper nautical charts sufficient for the intended voyage

Some Flag States may, however, permit other options (for example: radar-based systems such as “Chart-Radar”). Ship owners should consult their national maritime administration for specific guidance.

At the request of the IMO, the IHO has sought information from its member states on which paper charts covering their territorial waters would be considered as *appropriate* to serve as a back-up to ECDIS. This information is presented on the IHO web site as part of the ENC coverage catalogue (See <https://iho.int/en/backup-paper-charts-0>).

3.7 What to do in areas without ENC coverage?

In 1998 the IMO recognised that it would take some years to complete global coverage of ENCs. As a consequence, the IMO ECDIS Performance Standard was amended by adding a new optional mode of operation for ECDIS - the Raster Chart Display System (RCDS) mode. In this mode Raster Navigational Charts (RNCs) can be used in ECDIS to meet the SOLAS carriage requirements for nautical charts. However, this is only allowed if approved by the Flag State of the ship concerned. The intention of the change was to provide the widest possible coverage of official electronic chart data for ECDIS in advance of complete global coverage with ENCs alone.

IMO took note of the limitations of RNCs as compared to ENCs (see Section D “*Differences Between Raster Chart Display (RDCE) and ECDIS*” of IMO MSC.1/Circ.1503 (as amended)). As a consequence, the revised ECDIS Performance Standard requires that when the RCDS mode is employed an ECDIS must be used together with “*an appropriate folio of up to date paper charts*”.

The following definition of *an appropriate folio of up to date paper charts* (APC) was established by MSC within appendix 7 of Resolution MSC.232(82):

Appropriate Portfolio of up to date paper Charts (APC) means a suite of paper charts of a scale to show sufficient detail of topography, depths, navigational hazards, aids to navigation, charted routes, and routing measures to provide the mariner with information on the overall navigational environment. The APC should provide adequate look-ahead capability. Coastal States will provide details of the charts which meet the requirement of this portfolio, and these details are included in a worldwide database maintained by the IHO. Consideration should be given to the details contained in this database when determining the content of the APC.

While paper charts are to be used with RNCs, the underlying intention was, nevertheless, to minimise the number of paper charts carried by a vessel when the RCDS mode was employed, but only to a level compatible with safe navigation. As stated by the IMO, ship owners should consult their Flag State regarding whether RCDS mode is allowed and under what conditions.

In any areas where both ENCs and RNCs are unavailable vessels must carry all the paper charts necessary for the intended voyage.

3.8 Does your ECDIS system meet IMO chart carriage requirements?

ECDIS Carriage Requirements – a summary:

Are ENC's available for area of operation?	YES	NO	YES	NO
What Digital Charts are being used in the ECDIS by the mariner?	ENC (coverage at an appropriate scale for navigation)	RNC (coverage at an appropriate scale for navigation)	RNC	Private charts (6)
What back-up system is required?	Independent ECDIS or other back-up solution required	Independent ECDIS or other back-up solution required	None required (3)	None required (3)
What are the requirements for the carriage of Official paper charts?	None needed (1) (except if back-up is a folio of paper charts)	An "appropriate" folio of up to date paper charts to be used in conjunction with the ECDIS in RCDS mode	All up to date paper charts required for safe navigation in areas where ENC's are available	All up to date paper charts required for safe navigation for the intended voyage
How is the ECDIS operating?	As an ECDIS	As an ECDIS in RCDS mode	As an ECDIS in RCDS mode	As an ECS
Does the ECDIS fulfil Chart Carriage Requirements?	YES (1)	YES (2)	NO (4)	NO(5)

Notes:

1. Some Flag States may require specific documentation to allow this.
2. Requires approval of vessel's Flag State – Flag State defines meaning of 'appropriate'.
3. Back-up system is only required if ECDIS is intended to meet carriage requirements.
4. For ECDIS to fulfil Carriage requirements vessels must use ENC's where these are available.
5. Paper charts (not the ECDIS) must remain the primary means of navigation.
6. If private charts are used in an ECDIS the system is regarded as operating as an ECS. ECDIS operating as ECS; ECS systems meeting RTCM or IEC standards; or Private charts meeting ISO standards being used in ECDIS, do not meet IMO chart carriage requirements.

It should be noted that interpretations between Flag State administrations may vary. Additionally in some countries Flag State administrations will require to check the equipment on board before issuing any certificates. Prospective ECDIS users should consult the vessel's Flag State administration for detailed information.

3.9 Can chart format names indicate carriage compliance?

There has been much confusion regarding the names used to describe electronic chart distribution formats. Figure 3-1 is intended to clarify this. From the diagram it can be seen that the same distribution format can be used for the delivery of both "private" (not produced officially by or on the authority of a Government, authorized Hydrographic Office or other relevant government institution) and official chart data. For example, 'BSB' is the term used for the distribution format of US and Canadian RNCs. The same term is also used for the distribution of private raster chart data in other areas (for example, in European waters).

There can also be confusion with ENC's and End-User Service Providers packages. Private vector chart data delivered in S-57 format does not meet IMO requirements and should never be described as an ENC. Similarly private vector data delivered in a SENC format can be mistaken as being ENC's delivered in the same SENC format.

The most important factor to consider in determining whether data is official is the electronic chart producer rather than the format. The electronic chart producing authority determines the status and the purpose for which the chart data may be used. The combination of the status of the chart data and the functionality of the particular device finally determines whether an electronic chart navigation “system” is operating as an ECDIS or as an ECS.

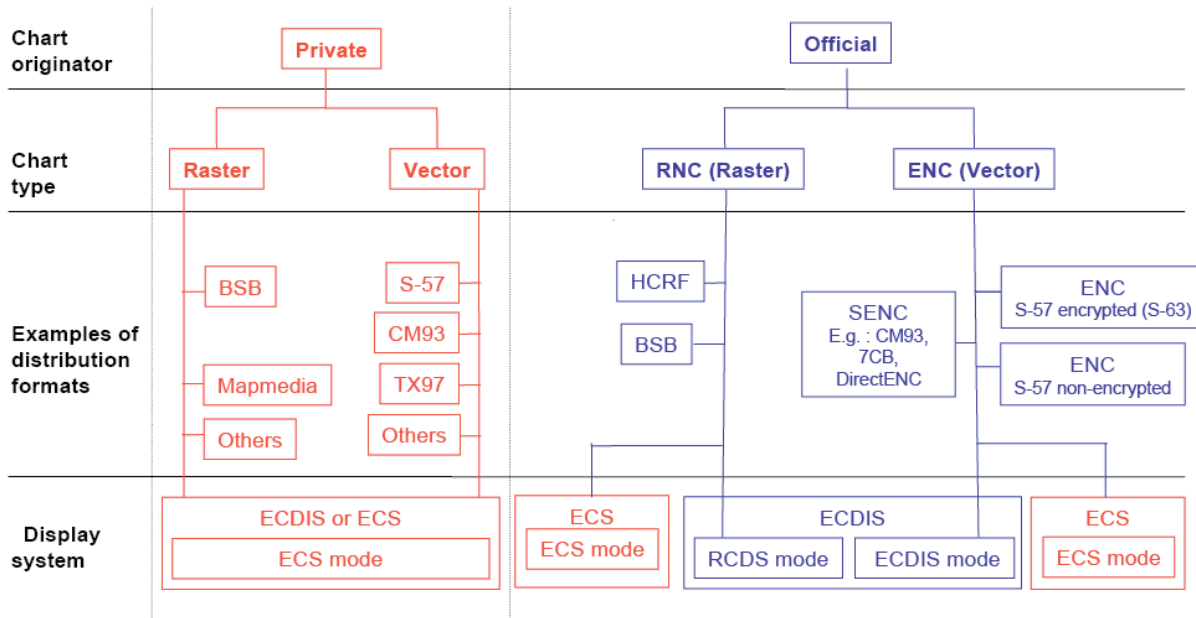

Figure 3-1 – Examples of Electronic Chart Formats. Many ECS systems are able to use ENC or RNC data, however even when using official charts they may not be used to fulfil ECDIS carriage requirements in accordance with SOLAS chapter V

Examples of format names used by private data producers:

- CM93 chart data produced by C-Map.
- TX90 vector chart data produced by Transas.

Section 4 ECDIS and Port State control

4.1 Acceptance of ECDIS by Port State Control Authorities

Ships arriving at a port are normally subject to Port State control. This is enforced by local officials (Port State Control Officers (PSCO's)) who refer to the relevant Flag State regulations and international agreements. Nations have formed a number of regional groups to ensure consistent application of Port State control.

In Europe, Port State control follows the guidance set out in the “*Guidelines for Port State Control on Electronic Charts (Paris Memorandum of Understanding)*”. Its ECDIS guidelines explain how a PSCO should assess whether a ship is using electronic charts in accordance with SOLAS requirements. Checks may include whether:

- The ship has documentation indicating that the ECDIS complies with the IMO ECDIS Performance Standards. In the absence of such documentation, the PSCO should seek confirmation from the Flag State that the ECDIS does meet the statutory requirements;
- The ECDIS is being used for primary navigation. It should be established if the ECDIS is used in ECDIS mode or RCDS mode or in both modes;
- There are written procedures onboard the vessel for using ECDIS;
- The master and watch-keeping officers are able to produce appropriate documentation that basic ECDIS familiarization has been completed and demonstrate familiarization with the ECDIS equipment installed on board;

4.2 IHO Advice for PSC Inspectors Concerning IHO Standards

4.2.1 be type-approved

To ensure ECDIS comply with the requirements in the relevant IMO performance standards they are tested against these requirements by approved Notified Bodies. The current testing standard for ECDIS is maintained by the International Electrotechnical Commission (IEC) and is IEC 61174 Edition 4.0 – *Maritime navigation and radiocommunication equipment and systems — Electronic chart display and information system (ECDIS) Operational and performance requirements, methods of testing and required test results*, published in August 2015. All ECDIS that are type approved according to IEC 61174 Edition 4.0 must comply with the display requirements in IHO S-52 Presentation Library Edition 4.0 and IHO S-63 Data Protection Scheme, Edition 1.2.

ECDIS type approved according to the previous editions of IEC 61174 need to be upgraded to the new IHO Presentation Library Edition 4.0. However there is no requirement that these ECDIS be updated to IHO S-63 Data Protection Scheme, Edition 1.2. The impact of this is that:

- Older ECDIS not yet updated to Presentation Library Edition 4.0 will not benefit from the significant changes introduced in Presentation Library Edition 4.0 and may not meet the chart carriage requirements as set out in SOLAS regulation V/19.2.1.4.
- Older ECDIS updated to Presentation Library Edition 4.0 but still using IHO S-63 Edition 1.1 will not be able to display an ENC Status Report from within the ECDIS.

All ECDIS approved within the European Union under the Marine Equipment Directive (MED) are given a Wheel Mark which is affixed to the equipment.

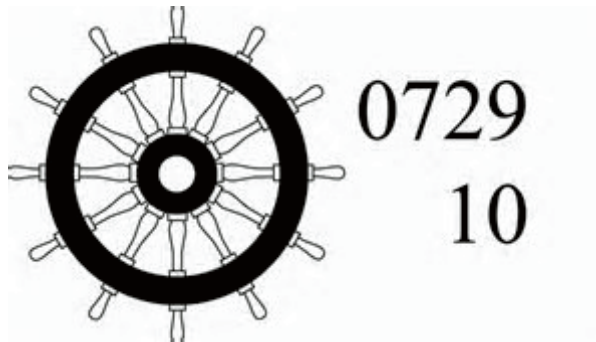

The first number denotes the Notified Body that awarded the type approval; the second number denotes the year the equipment passed approval.

4.2.2 use up to date electronic navigational charts (ENC)

Hydrographic Offices are required to keep nautical charts up to date to include all information considered to be relevant to safety of navigation (including temporary or preliminary information)²; and as such regularly issue updates to their ENCs. For an ECDIS to be used for navigation it must have the correct up to date ENCs for the intended voyage. Therefore the only indicator that the ENC data in the ECDIS is up to date is that the latest ENC update available for an ENC as issued by the Hydrographic Office has been applied to the SENC.

There are currently two chart distribution services an international mariner can sign up to for delivery of ENCs (noting there are also several national distribution services for mariners operating exclusively in national waters).

1. Standard subscription - ENC permits are purchased for a known operating area for a fixed periods of time (3 to 12 months). This enables the decryption of these ENCs in ECDIS and enables their use for planning and navigation.
2. Pay As You Sail (PAYS) – Mariners pay a minimal planning fee for upfront use of the entire global ENC data set. A tracking service is fitted to the vessel and as they navigate across ENCs they are charged accordingly. PAYS services can give instant access to most ENC chart across the globe.

To facilitate PSC inspections and to assist mariners in satisfying themselves that their ENC data is “up to date” S-63 was updated to Edition 1.2, adding an additional annex covering the ENC Status Report. Only ECDIS type approved according to Edition 4.0 of IEC 61174 will be capable of displaying the report. The report is a concise and standardized format designed for two individual use cases:

- a) To ensure that all ENC cells loaded into the ECDIS SENC are up to date for the next leg of a particular route; and
- b) To ensure that all ENCs loaded into the SENC are up to date.

Vessel Name:	HMS Goteborg			
Identifier:	IMO 4653321			
ENC Update Reference Date:	16 May 2013 : WK24/2013			
Date of Report:	1 Jun 2013			
Content:	Filtered for Route Plan "Goteborg – Kiel"			
Start WP:	Goteborg [57.7N,11.96667E]			
End WP:	Kiel [54.333742N,10.159607E]			
Chart Status Summary:				
Chart Status:	Count			
Total:	50			
Up to Date	38/50			
Not Up to Date	10/50			
Withdrawn	2/50			
Unknown	0/50			
Data Server: GB				
Cell Name	Edition	Update	Issue Date	Status
DE316001	5	1	13 Mar 2013	Not Up to Date
DE416010	1	1	12 Apr 2012	Not Up to Date
DE416020	6	2	11 May 2012	Not Up to Date
DE416021	8	3	10 May 2012	Not Up to Date

Figure 4-1 - Example ENC Status Report

If an inspection is carried out on a new ECDIS with this functionality it is important to understand how the ENC Update Status Report works and what the returned values mean.

The top of the report will list vessel name, IMO number and other important data. For the report to work correctly the ECDIS requires a reference date; this enables the system to calculate if an ENC cell has been updated. The date is taken from the last S-63 SERIAL.ENC file installed in the ECDIS which is delivered as part of the ENC exchange set from a data provider.

The data content of each of the header fields is defined in table 4-1:

Name	Data Type	Description
1. Vessel Name	Text	The name of the vessel as recorded within the ECDIS.
2. Identifier	Text	A unique identifier, the MMSI or vessel IMO number.
3. ENC Update reference date	Date	The data used as the reference for the status of each of the cells. This is the date stamp of the last data server's service media used to update the SENC. The date is taken from the S-63 SERIAL.ENC, expressed both in standard notation "NN MMM YYYY" and week number as defined in S-63.
4. Date of report	Date	The date the report was run.
5. Content	Text	This field denotes the content type of the report. There are two possibilities: "Filtered for Route Plan XXX to YYY" where XXX and YYY are the textual names of the point of origin and destination on the chosen route. Full SENC contents.
6. Start WP	Text	This field is only present if the report is filtered for a route. It should comprise the textual name of the starting waypoint of the route (if one exists) and the lat/lon coordinates of the waypoint. There is no fixed form that the coordinates should take.
7. End WP	Text	This field is only present if the report is filtered for a route. It should comprise the textual name of the last waypoint of the route (if one exists) and its lat/lon coordinates. There is no fixed form that the coordinates should take.

Table 4-1

² Refer to IHO Publication S-4 clauses B-600, B-601.7, B-633.1 and B-634.1

All the cells along an intended route are checked against the last ENC update reference date within the ECDIS. The ENC cells are then given a status; the description of each status type is given in table 4-2:

ENC Update 'Status'	Description
Up to date	<p>The ECDIS has all the latest update and/or new edition information for the cell installed as defined by the latest PRODUCTS.TXT data.</p> <p>NOTE: The ENC Update reference date must be within the last four weeks from the time of the report execution or the cell shall be displayed as "Not up to date" regardless of its status as defined by the PRODUCTS.TXT data.</p>
Not Up to date	<p>The ECDIS does NOT have installed the latest update and/or new edition for the cell. Again, the reference point for what should be installed is defined by the ENC Update reference date.</p> <p>NOTE: If the reference date is older than four weeks then cells shall be displayed as "not up to date" by definition.</p>
Withdrawn	<p>The number of cells which have been withdrawn by the data server or cancelled but which are still available within the ECDIS.</p>
Unknown	<p>Cells for which a status cannot be determined for any reason. If cells from a dataset with a "PARTIAL" PRODUCTS.TXT file are loaded then all cells in a data server's service but not included in the partial PRODUCTS.TXT shall be deemed to be "Unknown" as no definitive information on them can be determined. A "FULL" PRODUCTS.TXT content is required to specify the status of all cells in a data server's service.</p>

Table 4-2

4.2.3 be maintained so as to be compatible with the latest applicable International Hydrographic Organization (IHO) standards

All ECDIS have a function to display the current edition of the IHO Presentation Library being used to display the ENCs. Clause 19.1 of IHO ECDIS Presentation Library Edition 4.0 states: 'The edition number of the PresLib installed must be available to the Mariner on request'. This requirement is therefore tested for in ECDIS type approval – IEC 61174 Edition 4, clause 5.5.1.

For mariners that require a method to check that their ECDIS is capable of displaying the new symbols introduced in IHO S-52 Presentation Library Edition 4.0, the recommended course of action is to use ECDIS.



	<p>Magenta 'd' symbol used on ENC features that have a date dependent attribute populated.</p>
	<p>Indication highlight symbology for objects that pose a danger to the vessel.</p>
	<p>Automatic update symbology for identifying where changes to the ENCs have occurred.</p>

Figure 4-2 - New ECDIS symbols introduced in IHO S-52 Presentation Library Edition 4.0

4.2.4 have adequate, independent back-up arrangements in place

Details of a ship's navigational systems and equipment must be recorded in the "Record of Equipment". The means of complying with SOLAS regulation V/19 needs to be indicated (that is, paper charts and/or ECDIS) in the relevant "Record of Equipment". Declaring ECDIS in the ship's "Record of Equipment" makes ECDIS a surveyable item under SOLAS regulation V/19.

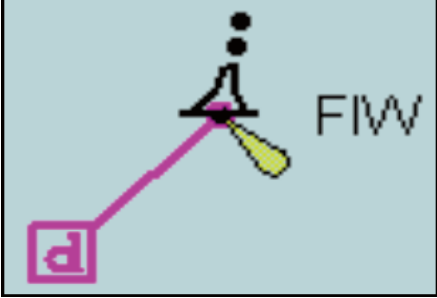
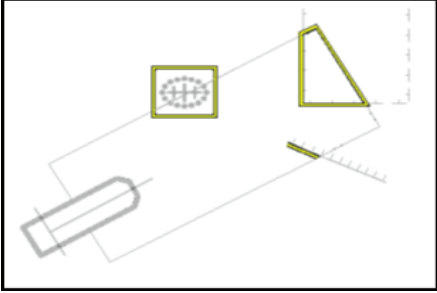
Section 5 Operational use of ECDIS and electronic charts

5.1 *Is there a need for ECDIS training?*

ECDIS is far more than the image of a chart displayed on an electronic screen. ECDIS is a highly sophisticated system which, besides the navigational functions, includes components of a complex, computer-based information system. In total, the system includes hardware, operating system, ECDIS software (kernel and user interface), sensor input interfacing, electronic chart data, rules for presentation and display, status and parameters of alarms and indications, etc. All these items are accessed through an appropriate human-machine interface. As such, care must be taken when navigating with ECDIS to avoid:

- Incorrect operation;
- Misinterpretation;
- Malfunction; or, even worse,
- Over-reliance on this highly-automated navigation system.

With any type of shipboard navigation equipment, it can only be as good as those who use it and what it is being used for. In the case of ECDIS and ENC, if the mariner is well trained then the system will provide the relevant information that the mariner needs to make good decisions and thereby contributes significantly to safe and efficient navigation. Stated another way, an ECDIS is another tool to enable mariners to perform their job better. However, just having some “knowledge” about “functions” and “operational controls” is insufficient to maximise the benefits of ECDIS; proper training is absolutely necessary.

The overall objective of ECDIS training is to enhance navigation safety. In rather general terms, this includes:

- Safe operation of the ECDIS equipment
- Use of the functions for route planning and monitoring
- Proper action in case of any malfunction
- Proper use of ECDIS-related information
- Selection, display, and interpretation of relevant information
- Ambiguities of data management (such as “datum”)
- Assessment of ENC data quality indicators (for example CATZOC)
- Assessment of alarms and indications – Awareness of ECDIS-related limitations
- Errors of displayed data and their interpretation
- Real and potential limitations
- Over-reliance on ECDIS – Knowledge of legal aspects and responsibilities related to electronic charts
- Awareness of the status of ECDIS and ECS; of official and non-official data
- Limitations of RCDS mode

In order to achieve these objectives, the mariner must acquire a thorough knowledge and functional understanding of the basic principles governing ENC data, its proper display in ECDIS and its use with navigation sensors and their respective limits. For example, the Mariner must be familiar with the object-attribute structure and the feature-space relationship of ENC data as well as charted information; and the impact of such things as “SCAMIN”, “overscale”, “update history”, “CATZOC”, “safety values” and “chart usage”.

ECDIS training must have an appropriate depth in theoretical aspects (ECDIS data and their presentation) as well as dealing with the proper use of ECDIS (functions and limitations). It should cover all safety-relevant aspects and go far beyond type-specific “button pressing” or basic operations. ECDIS training should be both generic and type-specific.

Ideally, training should cover the full extent of functions and procedures necessary to deal with a wide range of possible navigational problems. It should cover thorough route planning and both visual and automatic route monitoring in typical navigational situations and sea areas. To prepare a user for practical operations, decision-making and alarm handling, real-time complex ECDIS simulator exercises should be conducted.

See also Appendix 3 of IMO MSC.1/Circ.1503 (as amended) ECDIS – Guidance for Good Practice.

5.2 What are the requirements for ECDIS training?

The IMO Committee on Standards for Training and Watch-keeping (STW) approved a standardised IMO “Model Training Course on the Operational Use of ECDIS” (Model Course 1.27). The primary objective of the Model Course is to ensure proper use and operation of ECDIS in terms of a thorough understanding and appreciation of its capabilities and limitations. The IMO Model Course contains four main parts:

- Part A: Course framework;
- Part B: Course outline and time table;
- Part C: Detailed teaching syllabus;
- Part D: Instructor manual; and
- Part E: Evaluation and assessment.

There are also annexes dealing with proposals and examples of situations for the development of scenarios and of “errors of interpretation”.

In May 2012 (at the 43rd Standards of Training, Certification and Watch-keeping (STCW) meeting), the Model Course was revised and updated (annex to STW 43/3/1) in order to make provision for the generic use of ECDIS in addition to type-specific (“familiarization”) training.

The contents (syllabus) of ECDIS training are listed below. They are based on the analysis of onboard navigational activities and include learning objectives at the operational as well as the management level (for example STCW Convention). In addition to providing specific learning objectives and detailed guidance on a range of subject areas, the Model Course also contains recommendations for facility and staffing requirements, entry standards, lesson plans, teaching aids, examples of ship-simulator training exercises that can be conducted, and certificates.

- Legal aspects and requirements
- Main types of electronic charts and their differences
- ECDIS data – Presentation of data
- Sensors – Basic navigational functions
- Special functions for route planning
- Special functions for route monitoring – Updating
- Additional navigational functions and indications
- Errors in displayed data – Errors of interpretation
- Status information, warnings and alarms
- Voyage documentation
- System integrity monitoring
- ECDIS back-up
- Risks of over-reliance on ECDIS
- Upon completing the above course, a certificate should be issued. The certificate should document that:
 - The candidate has completed a course in the operational use of ECDIS (Electronic Chart Display and Information Systems), based upon the IMO Model Course 1.27 - The Operational Use of Electronic chart Display and Information systems (ECDIS).
 - The course fulfils the requirements of IMO STCW-95. The certificate should be issued by a government authority or a relevant body that is government approved.

5.3 What are the operational considerations when using ECDIS?

The IMO has recognised that the adoption of a carriage requirement for ECDIS from 2012 is a very significant change for the shipping industry and that there will need to be a careful transition both within the ship operating companies, and onboard the ships of their fleet. In 2008 the IMO issued a Safety of Navigation Circular (IMO SN/ Circ. 276) on “*Transitioning from paper chart to ECDIS navigation*”, which has been superseded and is now included at Section F of IMO MSC.1/Circ.1503 (as amended) *ECDIS – Guidance for Good Practice*.

Navigating with ECDIS is fundamentally different from navigating with paper charts. Important bridge work-processes are significantly affected, in particular, the voyage planning and voyage execution tasks. These differences require careful analysis and consideration.

5.4 Voyage Planning

ECDIS provides a number of additional planning functions and features such as the use of safety contours, various alarms and indications, and click-and-drop facilities for designating waypoints and markers. Whilst in many ways ECDIS makes voyage planning easier, it is still possible to make errors. However these errors are likely to be of a different type to those encountered when using paper charts.

Even though world-wide ENC coverage has almost been achieved, many vessels may, to some degree, have to operate a dual, or even triple, system with a voyage covered by various combinations of ENCs, paper and raster charts. The planning and validation of an intended voyage has therefore to consider issues such as which chart types are available for the various segments of that voyage. The format of the voyage plan is likely to differ from the traditional alphanumeric lists of waypoints used with paper charts and should include information on the usability of connected electronic navigational devices such as GPS and AIS and their actual alarm settings.

It is essential to make use of the in-built automatic checking functions provided by ECDIS when validating and approving the voyage plan. Thought also needs to be given to ensuring that a backup to the voyage plan on the ECDIS is available in case of equipment failure of the ECDIS or the connected sensors.

It is important that there is a good understanding of the voyage plan by all bridge officers so that they are prepared for the intended voyage. This should include information on equipment status and backup procedures.

5.5 Voyage execution

- At the beginning of a voyage, as well as at any change of watch, officers should review the voyage plan and agree the selected pre-settings of functions, alarms and indicators to be used on the ECDIS.
- Where vessels carry paper charts as well as an ECDIS, the role of the ECDIS and the paper charts should be considered. If the ECDIS is used for real time navigation, the statutory requirements regarding monitoring of the progress of the voyage and marking of positions will need to be considered:
 - o Are positions marked on paper charts solely for record keeping purposes?
 - o What steps are being taken to ensure that intended tracks marked on the paper charts correspond with the ECDIS information?
 - o Have the bridge procedures set in place by the shipping company been adapted for the use of ECDIS and are all persons concerned with the navigation of the vessel familiar with these adjustments?

5.6 Over reliance on ECDIS

There is a tendency to put too much trust in computer-based systems and, in the case of ECDIS, to believe implicitly in whatever is shown on the chart display. It is essential that officers remember to cross check the displayed information by all means available; especially by visual observation and comparison from the bridge window and by watching the radar. Bridge-procedures must be adapted appropriately and ENC training must be carried out to minimise the potentially adverse consequences.

5.7 More on ECS

All electronic chart systems, which are not tested and certified as meeting the IMO ECDIS Performance Standards, are generically designated as “Electronic Chart Systems” (ECS). An ECS may be able to use ENCs, RNCs or other chart data produced privately and could have functionality similar to ECDIS.

Some ECDIS and ECS equipment manufacturers also produce private vector and raster data to use in their products. These private charts are usually derived from Hydrographic Office paper charts or Hydrographic Office digital data but these derived charts have no official status.

Hydrographic Offices do not take any responsibility for the accuracy or reliability of privately produced charts. Where a SOLAS vessel operates with ECS, the paper chart remains the only officially recognised basis for navigation onboard. In these circumstances a vessel must retain and use a full folio of up to date paper charts onboard, regardless of the type of electronic charts used.

Because ECS is not intended to meet SOLAS chart carriage requirements, there is no IMO Performance Standard for ECS.

The STCW and ISM codes place the responsibility firmly on the ship-owner to ensure that mariners on their vessels are competent to carry out the duties that they are expected to perform. If a ship has an ECS fitted for use and it is being used as an aid to navigation, the ship-owner has a duty to ensure that users of such a system are properly trained in its use before employing it operationally at sea, are aware of its limitations compared to ECDIS and the need to use paper charts to fulfil the SOLAS chart carriage requirements.

5.8 Technical Details of Electronic Charts

5.8.1 Official Electronic Chart Data

The term “Official”, indicates chart data that has been produced under the authority of a government organization – in contrast to private, or non-official, electronic chart data which might be technically of the same type but has not been endorsed by a government authority. By definition, the terms ENC(s) and RNC(s) only refer to officially endorsed electronic charts.

5.9 Types of Official Chart Data

Electronic chart data is of two general types:

- Electronic Navigational Charts (ENC), and
- Raster Navigational Charts (RNC).

The inner construction of ENCs and RNCs is fundamentally different:

- ENCs are *vector* charts, and
- RNCs are *raster* charts.

5.10 Electronic Navigational Charts (ENCs)

5.10.1 General Principles

IMO's definition for the Electronic Navigational Chart – ENC:

Electronic Navigational Chart (ENC) means the database, standardized as to content, structure and format, issued for use with ECDIS by or on the authority of a Government, authorized Hydrographic Office or other relevant government institution, and conform to IHO standards. The ENC contains all the chart information useful for safe navigation and may contain supplementary information in addition to that contained in the paper chart (e.g. sailing directions), which may be considered necessary for safe navigation.

ENCs are vector charts comprising a database of individual geo-referenced objects extracted from a Hydrographic Office's records including existing paper charts. When used in an ECDIS, the ENCs content can be displayed as a seamless chart-like display at user selected scales. Due to the limited size and resolution of electronic displays the chart image generated from ENCs may not fully replicate the traditional appearance of a paper chart. This apparent shortcoming is more than compensated for by the special operational functions of ECDIS which continuously monitors the ENC data content (rather than the display) to provide warnings of impending dangers in relation to a vessel's position and its movement.

5.11 ENC Data Format

ENCs are formatted in accordance with the latest version of ENC Product Specifications as published by the IHO (See www.iho.int > ENCs & ECDIS > [Current ENC and ECDIS Standards](#)). These Product Specifications describe the standards to be used for the exchange of digital hydrographic data between national Hydrographic Offices and for the distribution of digital data and products to manufacturers, mariners, and other data users. The current ENC Product Specification is based on the IHO S-57 data format which is the IHO Transfer Standard for Digital Hydrographic Data. The current version of S-57 is Edition 3.1. A new ENC Product Specification S-101 is currently (2024) under development, based on the IHO S-100 Universal Hydrographic Data Model.

ENCs use the World Geodetic System 1984 (WGS 84) as the horizontal datum reference. This makes most ENCs directly compatible with GNSS. However, a few ENCs have been compiled from older non-WGS 84 paper charts and a close match with GNSS positions cannot be assured. These ENCs carry an extra warning that will be displayed in the ECDIS, such as "This chart cannot be accurately referenced to WGS 84 Datum; see caution message". A typical caution message would be: "Positions in this region lie within \pm nn metres of WGS 84 Datum".

See also IMO SN.1/Circ.213 *Guidance on Chart Datums and the Accuracy of Positions on Charts*; and IMO SN.1/Circ.255 *Additional Guidance on Chart Datums and the Accuracy of Positions on Charts* for additional information on horizontal datum reference.

5.12 ENC Display

An ENC is a database of geographic entities. It currently does not contain any presentation rules.

Both the geo-referenced data objects contained in the ENC and the appropriate symbolisation contained in the S-52 ECDIS Presentation Library are linked to each other in the ECDIS only when called up for display. The resulting image will change depending on the sea area selected, the intended display scale and the mariner's pre-settings, such as the display mode best suited to the ambient light conditions, and other operational conditions.

The presentation rules for ENCs are contained in a separate ECDIS software module - the "Presentation Library". The definition of the Presentation Library for ENCs is contained in Annex A of the IHO Publication S-52 – *Specifications for Chart Content and Display Aspects of ECDIS*. The use of the S-52 symbology and presentation rules is mandatory in all ECDIS.

The ECDIS Presentation Library follows, as much as possible the presentation and symbology used on a paper chart. This will avoid confusion during the extended period when paper charts, RNCs and ENC's will co-exist. However, the ECDIS display provides a much increased level of flexibility compared to a paper chart. This includes:

- Displaying/removing various types of chart and non-chart information;
- Selecting standard chart display or a thinned out display, and full or simplified symbols;
- Using cursor interrogation to obtain further detail not shown on the continuous display;
- Overlaying/removing radar video or radar target information (in order to: confirm ship's positioning; aid radar interpretation; show the entire navigation situation on one screen);
- Overlaying/removing various other sensor information, or information transmitted from shore;
- Changing the scale or orientation of the display;
- Selecting true motion or relative motion;
- Changing screen layout with windowed displays, providing text information in the margins, etc.;
- Possibility of pull-down menus and other operator interaction devices being alongside the operational navigation display and so interacting with it;
- Giving navigation and chart warnings, such as: "*too close approach to safety contour*"; "*about to enter prohibited area*"; "*over-scale display*"; "*more detailed (larger scale) data available*" etc.;
- Possibly, a diagrammatic representation of a computer evaluation of grounding danger;
- Possibly, a diagrammatic representation of the immediate vicinity of the ship to aid in close quarters manoeuvring;

The ambient lighting on the bridge varies between the extremes of bright sunlight, which can wash out information on the ECDIS display, and night, when the light emitted by the display has to be low enough that it does not affect the mariner's night vision. The colours and symbols specifications of S-52 have been designed to meet these more difficult requirements. ECDIS provides a negative image of the chart at night, using a dark background in place of the white background of the paper chart, in order not to impair night vision.

Three predefined colour schemes are provided:

- Day (white background)
- Dusk (black background)
- Night (black background)

Depth accuracy in ENC's may be described in three ways:

1. Generalized information through a Zone of Confidence (ZOC) indication (mandatory);
2. Quality descriptions of individual objects dangerous to safe navigation (similar to labelling of individual features as "*PA*" or "*PD*" on paper charts) (optional); and
3. Reliability of a survey (optional).

NOTE: *The optional methods listed in (2) and (3) are generally only viewable in ECDIS by utilizing the ECDIS Pick Report functionality (see clauses 4.2 and 4.3).*

SECTION 5

The following illustrations show two of the colour schemes and the three standard selections of content; that is Standard Display, Base Display and Full Display.

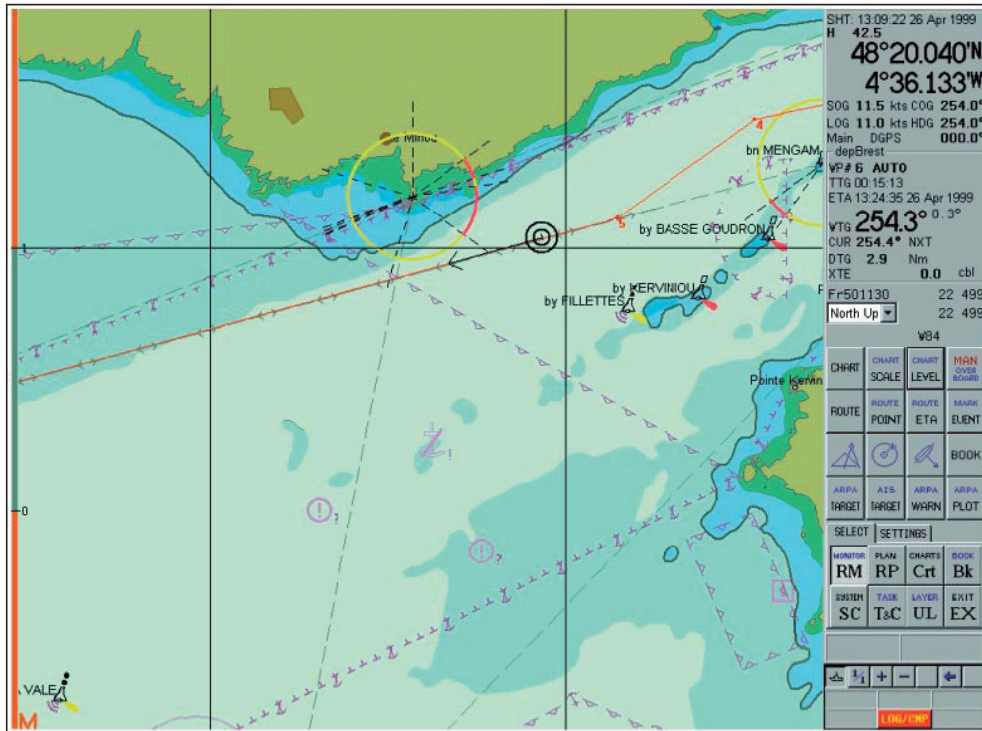

Standard Display, day

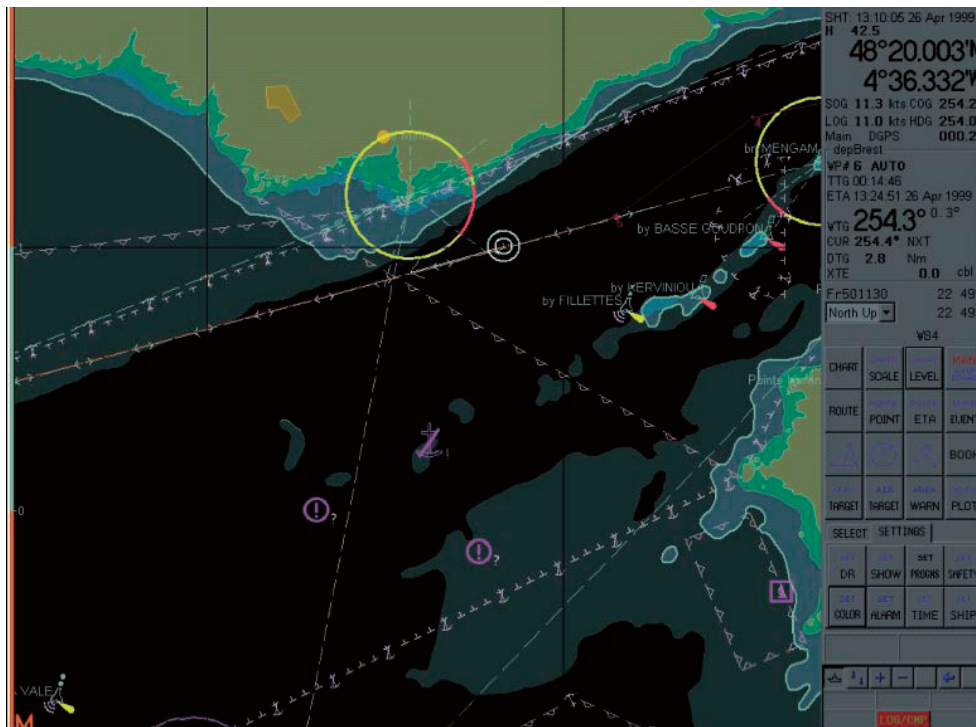

Standard Display, night

SECTION 5



Base Display, day

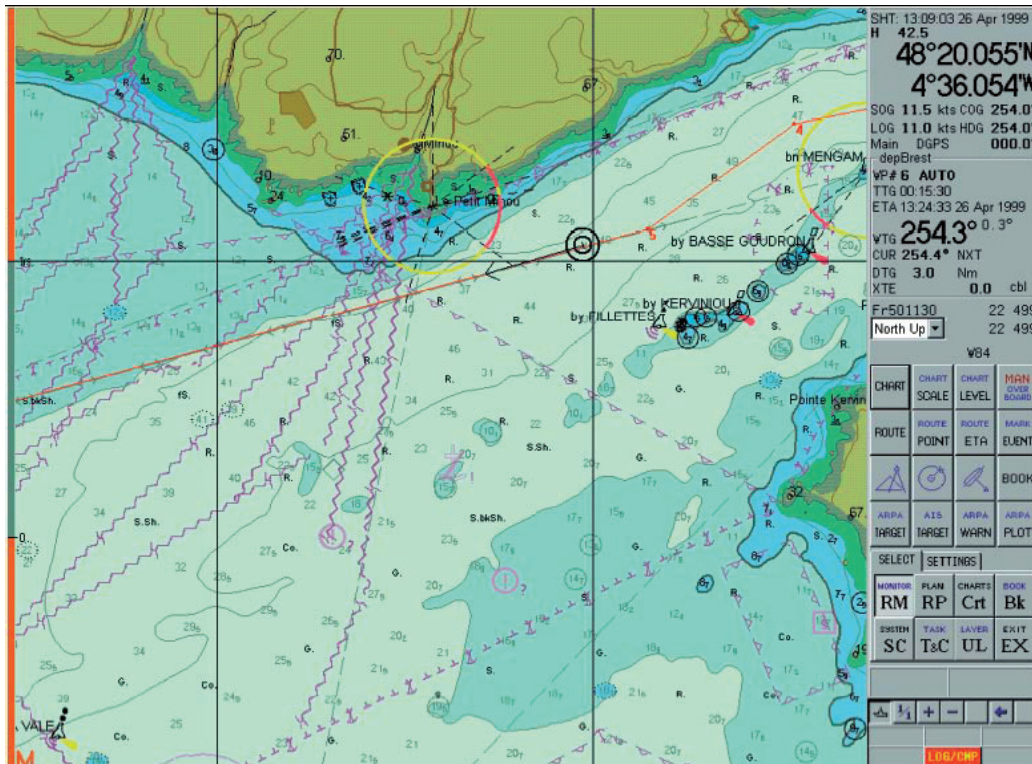

Full Display, day

5.13 What scale should an ENC be displayed at?

During production, ENCs are assigned a compilation scale based on the nature of the source data upon which they are based and their intended usage. They are also allocated to a Navigational Purpose related to this. This is analogous to a series of paper charts covering the same area, ranging from “small scale charts” to “large scale plans”. As shown in table 5-1 there are six Navigational Purposes (NOTE: scale ranges are indicative only).

Table 5-1 – Suggested assignment of Navigational Purposes to scale ranges

Navigational Purpose	Name	Scale Range
1	Overview	<1:1 499 999
2	General	1:350 000 – 1:1 499 999
3	Coastal	1:90 000 – 1:349 999
4	Approach	1:22 000 – 1:89 999
5	Harbour	1:4 000 – 1:21 999
6	Berthing	> 1:4 000

To facilitate the display of a radar overlay on ENCs, the IHO specifications recommend that hydrographic offices set the compilation scales of their ENCs to be consistent with the standard radar range scales as shown in table 5-2:

Table 5-2 – Radar range / standard scale

Selectable Range	Standard scale (rounded)
200 NM	1:3 000 000
96 NM	1:1 500 000
48 NM	1:700 000
24NM	1:350 000
12 NM	1:180 000
6 NM	1:90 000
3 NM	1:45 000
1.5 NM	1:22 000
0.75NM	1:12 000
0.5 NM	1:8 000
0.25 NM	1:4 000

5.14 ENC Compilation Scale

The viewing scale of a paper chart is determined and fixed by the cartographer at the chart compilation stage, so symbols are typically larger than the extent of the real-world feature they represent and do not change. The situation is different when ENCs are used in ECDIS as the Mariner can zoom in and out beyond the ENC compilation scale. Zooming in to a larger scale introduces the risk that any positional errors that may exist in the ENC data are magnified to a point where the data becomes unsafe to use – and this fact will not be immediately apparent as the ECDIS will continue to display the text and symbols at a fixed size.

ENC producers use a variety of methods to define the compilation scale of their ENC data, but for safety reasons these will always take into account the scale at which the source information was captured.

To ensure consistency, and thus contribute to improved display, most ENCs are assigned to one of the IHO's recommended standard compilation scales. These are defined within the IHO's S-65 publication, together with an example of the navigational purpose to which each ENC scale may be assigned.

The various compilation scales define the level of detail that can be included, and how that detail is depicted. While a feature may be depicted as an area or line feature at a large compilation scale, it may be depicted as a point feature at a smaller scale. Some object classes within an ENC, such as wrecks, rocks and obstructions including reefs, may therefore be defined by the cartographer as points, lines or areas depending on the compilation scale of the ENC and other factors. One major factor is whether the symbol for a feature will be larger than its true (real-world) extent, if known, at the chosen compilation scale.

Charted point features only indicate that a certain feature object exists in a given point location. While a light beacon may be charted as a point feature, a point feature may also define the approximate centre of a feature that actually has an 'area', such as a small reef. This means that, unlike charted area features, the only positional information available for a point feature is its geographical position (a point represented by latitude and longitude coordinates), and not its true extent (such as the distance from the charted point centre of a reef to its edge). This is particularly important in ECDIS where the Mariner chooses to over-scale the chart display (see figure 5-5).

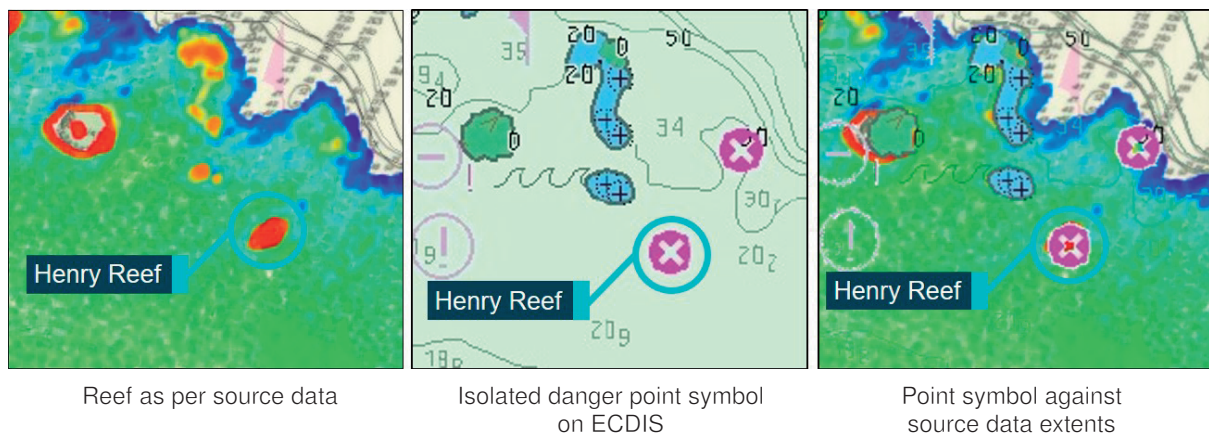

Figure 5-1: Comparison of small reef within source data at ENC compilation scale, point symbol depiction on ENC, and source data overlaid on ENC

Images show survey data (left), section of ENC (centre) and ENC superimposed on survey data at compilation scale (right).

Source: Australian Hydrographic Office (AHO) and ATSB³.

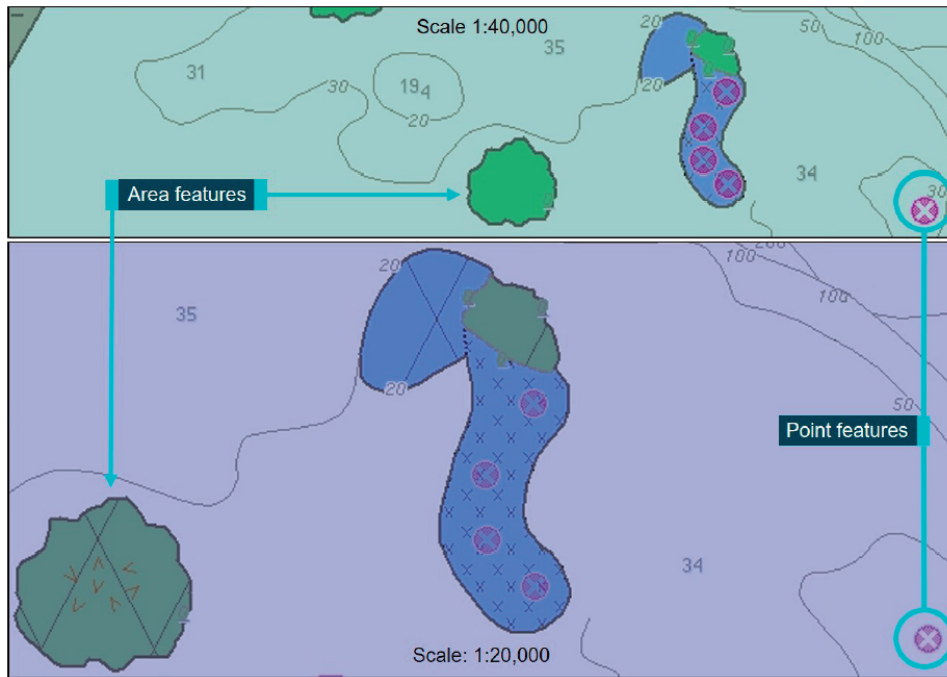

Figure 5-2: Comparison of area features and point features at different scales

These images show the same ENC displayed at two differing scales. The two images demonstrate a key difference between point and area features – area features change size in proportion to the ENC display scale, however the point features remain the same size regardless of display scale.

Source: Electrotech, annotations by the AHO.

5.14 Effect of over-scaling

Every ENC is compiled at an intended maximum viewing scale, known as the compilation scale. At this scale the maximum level of detail is revealed, while zooming out will progressively reduce the level of detail. None of this affects the accuracy of the chart. Zooming in may reveal a new, larger scale ENC, but this too has limits, and a point will be reached where there is no point zooming in further.

There is a common misconception by some Mariners that zooming in beyond the compilation scale of the ENC allows for greater accuracy – however, this is not the case. In reality zooming in beyond the intended maximum display scale of ENCs may be misleading and dangerous, particularly for ‘isolated dangers of depth less than the safety depth’. The risks associated with over-scaling the ENC within ECDIS are two-fold:

Firstly, the symbol selected by the cartographer to represent a real-world feature may no longer fully cover that feature.

Secondly, but most importantly, because the text and point symbols stay the same size within the over-scaled ENC, any sense of appropriate distance from a potential danger is no longer intuitive and can result in a false sense of safety that does not reflect reality.

The display scales available to mariners in an ECDIS are not standardized and they vary between different ECDIS. Hydrographic Offices on the other hand are recommended by the IHO to compile their ENC's using one of the predefined scale values shown in table 5-3. These scale values, although developed to align as close as possible with standard radar ranges, do not always match the display scale step values available to mariners in ECDIS. Consequently, mariners are strongly recommended, especially during route monitoring, to use the 1:1 ECDIS display setting where available. This setting will display the ENC at the intended viewing scale for the position of the vessel. Mariners will then benefit from the maximum level of detail available in the ENC without the risk of over-scaling.

Table 5-3 – Recommended standard ENC compilation scales

Selectable range	Standard scale (rounded)
200 NM	1:3.000.000
96 NM	1:1.500.000
48 NM	1:700.000
24 NM	1:350.000
12 NM	1:180.000
6 NM	1:90.000
3 NM	1:45000
1.5 NM	1:22.000
0.75 NM	1:12.000
0.5 NM	1:8000
0.25 NM	1:4000

5.15 ENC over-scaling

There is also a general relationship between the scale of an ENC and its intended purpose. ENC's intended for coastal navigation or approaching a port will generally be compiled at a smaller scale than ENC's intended for more precise navigation and manoeuvring within a port. For instance, on a coastal navigation ENC there is generally no intention by the Hydrographic Office to present the charted information such that mariners can navigate within close proximity of isolated dangers (for example hazards covering an area may be depicted as point features); if this was the intent the ENC would be compiled at a much larger scale. Over-scaling an ENC effectively breaks this relationship between the scale at which the charted information is being displayed and the intended usage of this information.

A key difference to note between charted area features and point features on an ECDIS display is that area features change size in proportion to the scale at which the ENC is being viewed, whereas point feature size remains constant irrespective of display scale (see figure 5-2); in other words, they are not enlarged as viewing scale is increased.

Additionally, the size and shape of the point symbol does not necessarily represent the size or shape of the physical, real-world feature it is depicting.

Traditionally, nautical cartographers have sought to ensure that the symbol on the chart is larger than the real-world feature it represents when seen at the chart's compilation scale. Navigational purpose is also taken into consideration; a chart that is intended for coastal navigation, where it is not intended that the chart is to be used for close approach to isolated features, may also factor into the decision of the cartographer as to whether to depict a feature as an area or a point symbol on the chart. This practice remains true in the preparation of ENC, where the compilation scale defines the maximum intended viewing scale for that ENC in ECDIS.

However, when the ENC is viewed at scales progressively larger than the compilation scale, the intended relationship between the point symbol and the area feature it represents is broken; as the ENC is progressively 'over-scaled' on screen, the symbol represents a progressively smaller proportion of the real-world feature, such as a reef area, on the ECDIS display. This can lead to an incorrect assumption by the Mariner that they may go closer to the edge of the point symbol when the display is 'over-scaled'; this would be a dangerous assumption.

As a point feature, a reef is charted in a specific latitude/longitude position on the ENC, typically representing the centre of the area of the reef. Visually, this means that the symbol representing the reef will always be centred on this position (see figure 5-1); and when viewed at the ENC compilation scale, or smaller, the symbol will typically cover the true extent of that reef. On the ECDIS display, the symbol always maintains an absolute size of 7mm in diameter regardless of the scale at which the ENC is viewed (see figure 5-3). However, if the display scale has been over-scaled to twice the ENC compilation scale, a considerable extent of the reef (previously covered by the symbol), may now extend well beyond the symbol, without any indication of such in the ECDIS (see figure 5-5).

Isolated danger of depth less than the safety contour

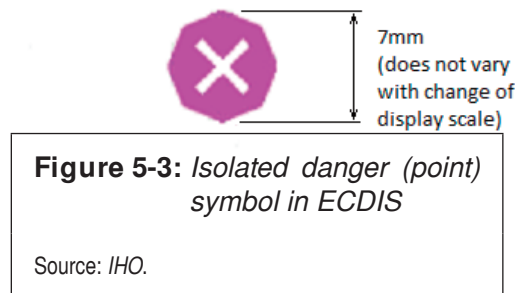

The ECDIS has the functionality to allow ENCs to be displayed at scales larger than the original compilation scale. However, the ability to zoom in beyond the compilation scale (the maximum intended viewing scale) has introduced an inherent risk that is not present in paper charts. To minimize these risks, ECDIS includes indicators to alert when an ENC is being viewed beyond the maximum intended viewing scale.

1. Over-scale indication shown within the graphical user interface
2. Over-scale (jail bar) pattern

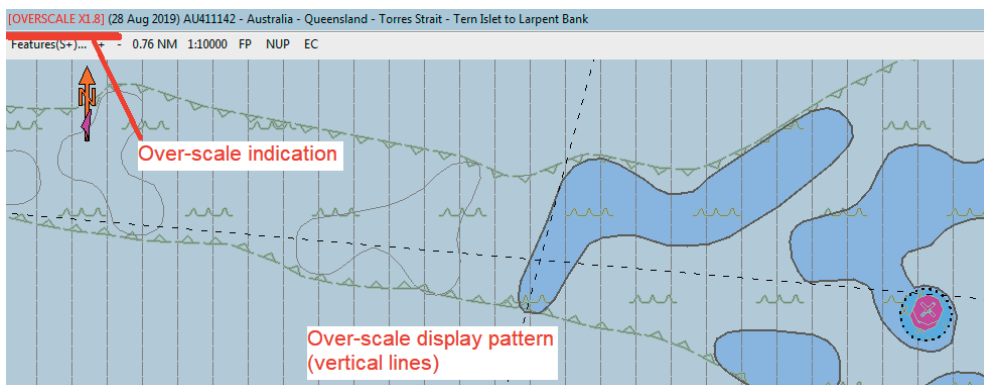

Figure 5-4: Over-scale indication and over-scale pattern on ECDIS

Source: AHO.

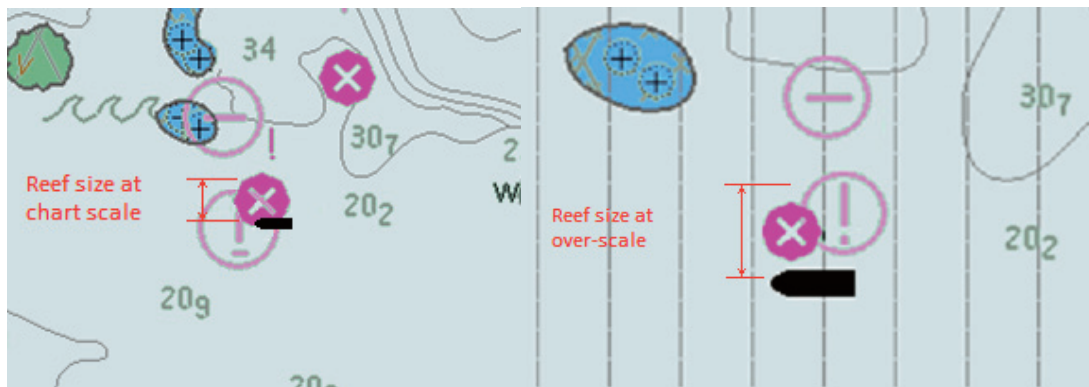

Figure 5-5: Over-scale indication and over-scale pattern on ECDIS

In the image on the left, shown at maximum intended viewing scale, a Mariner can immediately see that passing close to the charted isolated danger would be unwise. In contrast, in the image on the right, shown over-scaled, passing the same distance from the same isolated danger appears safe. Unfortunately, as the symbol has not been enlarged in proportion to the display scale, it no longer fully covers the reef, resulting in a hazardous navigation situation.

Source: AHO.

It is important to also note that the ECDIS will provide an indication if the ship's position is covered by an ENC at a larger scale than the current ENC being used in the ECDIS display.

A large scale chart covers a small area with high level of details. The associated Zones of Confidence therefore also are provided to a high level of detail. When transitioning to a smaller scale chart, at some point two adjacent CATZOC areas will merge into one. At that point only the lesser value of the two CATZOCs will be available for safety reasons. Shipping accidents have occurred when mariners did not have the largest scale chart in their ECDIS available; they over-scaled using a medium scale chart, and ran aground by passing too close to isolated underwater dangers.

5.16 Conclusions and recommendations

With many additional ENC tools capable of planning routes the Mariner must still be aware that only the ECDIS is certified for carrying out route planning and monitoring. To ensure safety and compliance it is imperative that all the appropriate scale ENCs are used in the ECDIS for adequate route planning and monitoring. The route must be automatically safety checked and a visual inspection performed at the largest scale possible, based on the available portfolio of ENCs, before the voyage commences. To ensure all dangers are identified by the ECDIS auto safety check function the Cross Track Distance must be appropriately set, taking into account factors such as the accuracy of the ship's positioning and navigation system; the bathymetric data quality information included in the ENCs (such as CATZOC); and the Compilation Scale of the ENCs loaded into the ECDIS.

Mariners are strongly advised not to zoom in ECDIS beyond the compilation scale to a point where the ECDIS over-scale indication or pattern are triggered. Some ECDIS allow the operator to turn off over-scale warnings. This is not recommended under normal circumstances.

Familiarization with all the core functions of the ECDIS are mandatory requirements within STCW and are essential for safe navigation. Mariners must be familiar with the properties of the ECDIS; and develop a sufficient understanding of how and when the ECDIS indicates that ENC data is being displayed at an unsafe scale, so that the display settings can be adjusted accordingly.

5.17 Dangerous effects of over-scale ECDIS Display near 'Isolated dangers'

Use of over-scale display of an ENC may be dangerous in certain circumstances. There is a mistaken belief that zooming in allows for greater accuracy; however, this is not the case. In reality, zooming in beyond the compilation scale of the ENC may be misleading and dangerous, particularly for '*Isolated dangers of depth less than the safety depth*'; as any positional errors included in the data are magnified. The over-scale indicator in the ECDIS should therefore be heeded as a measure to prevent over-scaling the chart.

Every ENC is compiled at an intended maximum viewing scale, known as the compilation scale. At this scale the maximum level of detail is revealed, while zooming out will progressively reduce the level of detail. None of this affects the accuracy of the chart. Zooming in may reveal a new, larger scale ENC, but this too has limits, and a point will be reached where there is no point zooming in further.

At the ENC compilation scale, area details which are too small to chart, but which still present a hazard to navigation, are typically replaced by a point symbol larger than the charted size of the feature (such as a very small reef). Zooming in to over-scale negatively impacts the relationship between the scaled size of the (now larger) real-world area hazard and the size of the symbol.

Isolated danger of depth less than the safety contour

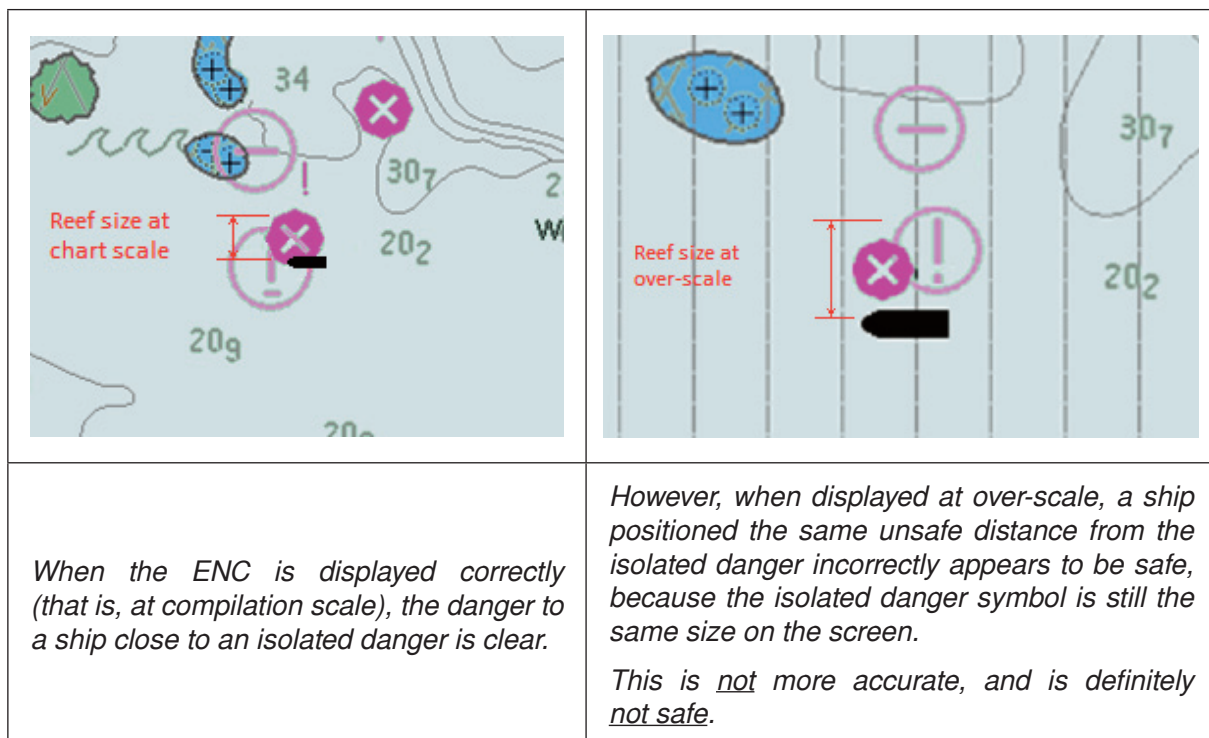
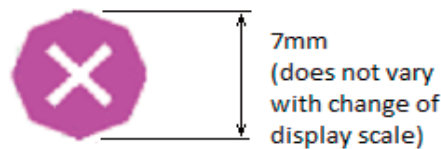

Figure 5-6 – Effect of over-scaling on relationship between point symbol and real-world feature

Remember, the positioning accuracy of the isolated danger may be worse than 500 metres. Routes should be planned to clear these dangers by at least as far as the ZOC category immediately around the danger dictates.

Section 6 Accuracy of depth information in Electronic Navigational Charts

Accuracy of depth Information in an ENC can be visualized by showing the Zones of Confidence (ZOC) areas. A ZOC area is a generalized picture of the quality of charted depth information for that area. The quality of the hydrographic source data is assessed according to six categories (CATZOC): Five quality categories for assessed data (A1, A2, B, C and D); and a sixth category (U) for data which has not been assessed. The assessment of hydrographic data quality and classification into zones by Hydrographic Offices is based on a combination of:

- Depth accuracy;
- Position accuracy; and
- Seafloor coverage.

For ease of reading, this can be interpreted as follows:

1. High accuracy depth information (ZOC A1 and A2), shown as 5 stars or more.
2. Medium accuracy depth information (ZOC B), shown as 4 stars.
3. Poor accuracy depth information (ZOC C, D and U), shown as 3 stars or less; or letter U.

ZOC can be visualized in an ECDIS by activating the ECDIS “Accuracy” selector. The following recommendations are made to the mariner:

- When planning a new voyage, ZOCs should be visualized as an overall check of the quality of the area the vessel is going to transit.
- When changing the planned route whilst en-route, the ZOCs should be visualized as an overall check of the quality of the area the vessel is going to transit.
- When route planning in areas with ZOC A1 and A2, the mariner should consider that isolated dangers and shallow soundings could be up to 20 metres from their charted position and at least 0.5-1 metre shoaler/deeper than their charted depth.
- When route planning in areas with ZOC B, the mariner should consider that isolated dangers and shallow soundings could be up to 50 metres from their charted position and at least 1 metre shoaler/deeper than their charted depth.
- When route planning in areas with ZOC C, D and U, the mariner should consider that isolated dangers and shallow soundings could be up to 500 metres from their charted position and at least 2 metres shoaler/deeper than their charted depth.
- The mariner should take note of the accuracy of the depth areas the vessel is planning to transit and take appropriate caution by applying appropriate safety margins, especially in situations where under keel clearance is critical and/or in areas of continual and rapid change.
- The mariner should take the horizontal accuracy as defined by the CATZOC for the area into consideration when setting cross track distance for the automatic route check function performed during the voyage planning.
- In ZOC C, D and U the mariner is advised to take caution as charted depths may in reality be significantly shallower. It is very likely that some significant seafloor features dangerous to the safety of navigation (rocks, coral reefs, wrecks, submerged obstructions) have not been identified, and do not appear in the chart.
- By using a Pick Report in ECDIS, the mariner can read additional quality information on isolated dangers to the safety of navigation and/or survey reliability, if these have been included in the ENC. Otherwise the mariner should assume that the isolated danger may in reality be out of position and/or be shallower as indicated by the CATZOC.

- The mariner must ensure to have the full portfolio of ENC's available at the appropriate chart scales suitable for the voyage being undertaken, as ECDIS in-built safety functions use the data encoded in the largest scale product available in the system (irrespective of it being displayed or not) to trigger alarms. ECDIS does allow the mariner to over-scale, however this will give a false sense of security of the accuracy of isolated dangers if CATZOCs are not checked; and their extent (see Annex B). Over-scaling the ECDIS display is not recommended under normal circumstances; as a consequence the over-scale indicator in the ECDIS should be heeded.
- Areas of continual and rapid change occur in many tidal rivers and estuaries; over bars in the approaches to some ports; and over some off-lying banks. A limitation of the CATZOC system is the lack of information about when a survey was conducted, or whether the seabed is stable; noting however that the date that a survey was conducted in an area may be available in the ENC through an ECDIS Pick Report. It is therefore considered important for mariners to note areas of sand-waves; dates within dredged channels; and any other notes advising that channels may have changed or are subject to change.

Put in simple terms, mariners should be able to navigate with confidence in areas with ZOC A1 and A2 classifications. It is also unlikely that uncharted dangers affecting surface navigation exist in ZOC B areas. In ZOC C areas mariners should exercise caution since hazardous uncharted features may be expected, particularly in or near reef and rocky areas, or areas of mobile seabed. A very high degree of caution is required for areas assessed as ZOC D, as these contain either very sparse data or may not have been surveyed at all. Finally, it is good practice for mariners to treat ZOC U areas with the same degree of caution as ZOC D areas.

Within ports, the Pilot or Harbour Master may advise that higher accuracy surveys have been conducted that allow for smaller under-keel clearances (subject to tides, weather, speed, and manoeuvring margins). In the absence of this advice, smaller under-keel safety margins should not be assumed.

In coastal shipping areas the most common assessments likely to be encountered are:

- ZOC B – around 40% of the world's coastal waters;
- ZOC C – around 30% of the world's coastal waters;
- ZOC D – around 10% of the world's coastal waters; and
- ZOC U – around 15% of the world's coastal waters.

While these percentages may vary from place to place, the key point to note is that the standards of surveying in ports are only very rarely encountered outside those ports. Ships may therefore be at greater risk away from ports, even though depths may be deeper. The risk will decrease with increasing under keel clearance (depths greater than 100 metres); and depth areas deeper than 200 meters are generally considered safe for surface navigation. An understanding of how much confidence can be placed in the depth information in an ENC is therefore most important.

6.1 Generalized information

The quality of the bathymetric data charted on the ENC is assessed according to six categories (CATZOC or ZOC): five quality categories for assessed data (A1, A2, B, C and D) and a sixth category (U) for data which has not been assessed³ (see table 6-1). The CATZOC is an attribute included in the S-57 object class M_QUAL (Quality of Data). CATZOC indication covers all areas of the ENC that contain bathymetry; never overlap; and have no gaps between them. The assessment of bathymetric data quality and classification into zones is based on a combination of:

- Position accuracy;
- Depth accuracy; and
- Seafloor coverage.

Table 6-1 – ZOC Categories

ZOC	Position accuracy	Depth accuracy	Seafloor coverage
A1	± 5 m + 5% depth	0.50 m + 1% depth	Full area search undertaken. Significant seafloor features detected and depths measured.
A2	± 20 m	1.00 m + 2% depth	Full area search undertaken. Significant seafloor features detected and depths measured.
B	± 50 m	1.00 m + 2% depth	Full area search not achieved; uncharted features hazardous surface navigation are not expected but may exist.
C	± 500 m	2.00 m + 5% depth	Full area search not achieved, depth anomalies may be expected.
D	Worse than ZOC C	Worse than ZOC C	Full area search not achieved, large depth anomalies may be expected.
U	Unassessed – The quality of the depth data has yet to be assessed.		

The full version of this table, including the explanatory notes relating to each category, can be found in Annex A.

The position accuracy is the cumulative error and includes in general survey; geodetic transformation; and digitizing and compilation errors. The higher CATZOC categories, A1 and A2, are categorized by full seafloor search or sweep and very high accuracy standards only achievable with technology that has been available since about 1980. Therefore many sea lanes which have hitherto been regarded as adequately surveyed may carry a ZOC B classification. Modern surveys of critical areas can be expected to carry ZOC A2 classification whilst ZOC A1 will cover only those areas surveyed under exceptionally stringent conditions.⁴

Figure 6-1 provides a graphical representation of the impact of the position accuracy and depth accuracy on a charted feature; in the graphic, the actual real-world location of the charted 5 metre obstruction may be anywhere within the cylinder, the volume of which is defined by the assigned CATZOC values as defined in table 6-1.

⁴ Adapted from S-4 clause B-297.4

⁵ Adapted from S-4 clause B-297.6

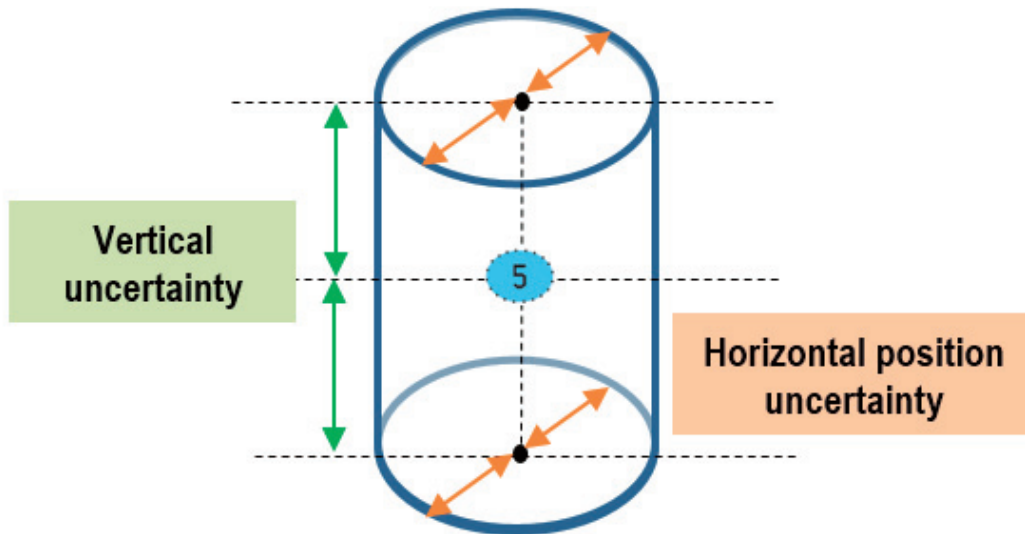

Figure 6-1 – Charted feature depth and position accuracies accounting for ZOCs

One limitation of the CATZOC system is the lack of information about when a survey was conducted, or whether the seabed is stable. While the date can be provided in an additional data field within an ENC, this is rarely done; and can only be viewed by the mariner using the ECDIS Pick Report function. In areas where the seabed is subject to change, ENC encoding guidance recommends the inclusion of the date of the survey(s) and/or downgrading of the assigned ZOC category, restoring it only once a replacement survey is incorporated in the ENC. However, this isn't always done, so it is wise to note areas of sand-waves; dates within dredged channels; and any other notes advising that channels may have changed or are subject to change.

Figure 6-2 depicts where a charted shoal may be out of position. The difference between the charted and true position of a shoal may be much greater than the difference between the GNSS measured ship's position and the ship's true position. Mariners are advised to take appropriate caution.

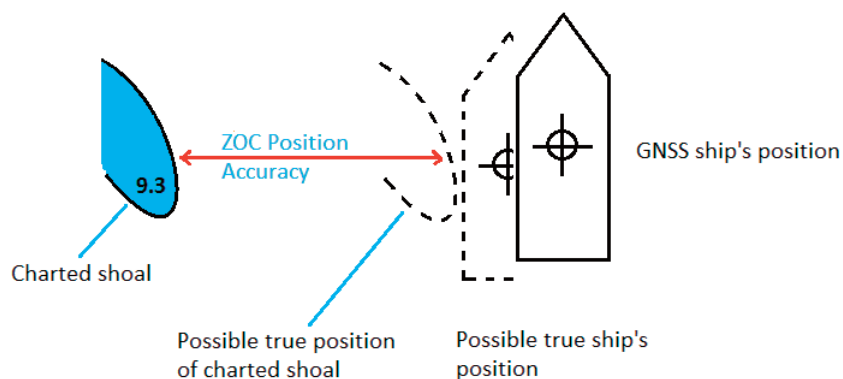

Figure 6-2 – Horizontal position accuracy accounting for ZOCs and ship's GNSS position

- *A planned route should allow for both chart accuracy and ship's positioning accuracy, as well as other factors. The dashed lines indicate the possible worst-case scenario for the mariner.*

For ease of reading, table 6-1 can be interpreted as follows:

1. High accuracy depth information (ZOC A1 and A2)
2. Medium accuracy depth information (ZOC B)
3. Poor accuracy depth information (ZOC C, D and U).

6.2 High accuracy depth information

The depth of this area has been measured by a collection of regular, controlled or systematic hydrographic surveys. Significant seafloor features dangerous to the safety of navigation (rocks, coral reefs, wrecks, submerged obstructions) have been identified, accurately positioned and their least depth value has been accurately determined. Therefore, when route planning in areas with ZOC A1 and A2, the mariner should consider that isolated dangers and shallow soundings could be up to **20 metres** from their charted position; and at least **0.5 to 1 metre** shoaler/deeper than their charted depth (refer to table 6-4).

6.3 Medium accuracy depth information

There is a risk that significant seafloor features dangerous to the safety of navigation (rocks, coral reefs, wrecks, submerged obstructions) have not been identified, and do not appear in the chart. Those features that are present in the chart have a horizontal accuracy of ± 50 metres and a depth accuracy of at least ± 1 metre (refer to table 6-1). Therefore, when route planning in areas with ZOC B, the mariner should consider that isolated dangers and shallow soundings could be up to **50 metres** from their charted position; and at least **1 metre** shoaler/deeper than their charted depth (refer to table 6-4).

6.4 Poor accuracy depth information

The mariner should take appropriate caution when navigating through this area. Charted depths may in reality be significantly shallower. It is very likely that some significant seafloor features dangerous to the safety of navigation (rocks, coral reefs, wrecks, submerged obstructions) have not been identified, and do not appear in the chart. Those features that are present in the chart have a horizontal accuracy of ± 500 metres and a depth accuracy of at least ± 2 metres (refer to table 6-1). Therefore, when route planning in areas with ZOC C, D and U, the mariner should consider that isolated dangers and shallow soundings could be up to **500 metres** from their charted position; and at least **2 metres** shoaler/deeper than their charted depth (refer to table 6-4).

6.5 Quality descriptions of individual objects dangerous to safe navigation

In S-57 – “IHO Transfer Standard for Digital Hydrographic Data”, the following (subsurface) items are considered to be hazardous to safe navigation:

- Obstructions
- Rocks and reefs
- Wrecks

The individual encoding of these items, as well as soundings, may contain additional quality information only applicable to the item. The structure of the ENC allows Hydrographic Offices to add this information, however it is not mandatory for them to do so. Individual obstructions, rocks, reefs, wrecks and soundings may have the following additional quality information:

The following items are considered to be an obstruction ⁶:

- Snags
- Stumps
- Wellheads
- Diffusers
- Cribs
- Fish havens
- Foul areas
- Foul ground
- Booms
- Ice booms
- Sites of cleared platforms
- Ground tackle

For obstructions, note the difference between a foul area and a foul ground. A foul area is defined as an area of numerous uncharted dangers to navigation. If the Hydrographic Office creates a foul area in an ENC, it will show in an ECDIS “base display” as an obstruction to navigation, with all associated alarms to indicate that it is unsafe for vessels to enter or transit the area.

Foul ground is defined as an area over which it is safe to navigate but which should be avoided for anchoring, taking the ground or fishing. Foul ground included in an ENC will only show in ECDIS “other display”, with no associated alarms or indications.

NOTE: Booms, ice booms and ground tackle included in ENC perform the same in ECDIS as foul ground.

6.6 Survey reliability

The Hydrographic Office may provide additional quality information on individual surveys used in compiling the ENC, using the M_SREL (Survey Reliability) object class. The information, when included in the ENC, can be viewed by executing a pick report on the area. The components of the information are ⁷:

⁶ S-57 Appendix B.1, Annex A – Use of the Object Catalogue for ENC, clause 6.2.2

⁷ Adapted from S-57 Appendix A, Chapter 2 – Attributes

Table 6-2 – Additional quality information for obstructions, rocks, reefs, wrecks and soundings

Attribute	Allowable values	Definitions
Obstruction (OBSTRN) Rock (UWTROC) Wreck (WRECKS) Sounding (SOUNDG)	Exposition of sounding (EXPSOU) (Some types of obstructions may have a different least depth as compared to the depth range assigned to the surrounding area, such as a 10 metre wreck lying in a 15 to 20 metre depth area)	<ol style="list-style-type: none"> 1. within the range of depth of surrounding depth area 2. shoaler than the range of depth of surrounding depth area 3. deeper than the range of depth of surrounding depth area
	Quality of sounding (QUASOU) (Values 3, 4, 6, 8, 9 and 11 have essentially the same practical meaning – that the true depth may differ from the charted depth)	<ol style="list-style-type: none"> 4. depth known 5. depth unknown 6. doubtful sounding 7. unreliable sounding 8. no bottom found at value shown 9. least depth unknown 10. least depth unknown, safe clearance at value shown 11. value reported, not surveyed 12. value reported, not confirmed 13. maintained depth 14. not regularly maintained
	Sounding Accuracy (SOUACC) (May be populated only if different from the depth accuracy as indicated by the CATZOC value)	Value in metres
	Technique of sounding measurement (TECSOU) (While some Hydrographic Offices may state the equipment used to determine the position and depth of a feature, mariners should primarily focus on the CATZOC value and other specific quality attributes, rather than the equipment used)	<ol style="list-style-type: none"> 15. found by echosounder 16. found by side-scan sonar 17. found by multi-beam 18. found by diver 19. found by lead-line 20. swept by wire drag 21. found by laser 22. swept by vertical acoustic system 23. found by electromagnetic sensor 24. photogrammetry 25. satellite imagery 26. found by levelling (not applicable) 27. swept by side-scan sonar 28. computer generated

The mariner can execute a “Pick Report” in the ECDIS to show the underlying information of an obstruction, rock, reef, wreck or sounding.

The value of the overlaying CATZOC applies to the horizontal accuracies of individual obstructions, rocks, reefs, wrecks and soundings. However, note that the horizontal position accuracy for individual objects may be encoded using the attributes POSACC and QUAPOS on the associated spatial objects where these individual objects have a different positional accuracy than the overlaying CATZOC indicates.

Table 6-3 – Components of survey reliability

Attribute	Allowable values	Definitions
Quality of Position (QUAPOS)	1: surveyed	The position(s) was(were) determined by the operation of making measurements for determining the relative position of points on, above or beneath the earth's surface. Survey implies a regular, controlled survey of any date.
	2: unsurveyed	Survey data is does not exist or is very poor.
	3: inadequately surveyed	Position data is of a very poor quality.
	4: approximate	A position that is considered to be within 30.5 metres of its correct geographic location. Also may apply to an object whose position does not remain fixed.
	5: position doubtful	An object whose position has been reported but which is considered to be doubtful.
	6: unreliable	An object's position obtained from questionable or unreliable data.
	7: reported (not surveyed)	An object whose position has been reported and its position confirmed by some means other than a formal survey such as an independent report of the same object.
	8: reported (not confirmed)	An object whose position has been reported and its position has not been confirmed.
	9: estimated	The most probable position of an object determined from incomplete data or data of questionable accuracy.
	10: precisely known	A position that is of a known value, such as the position of an anchor berth or other defined object.
	11: calculated	A position that is computed from data.
Quality of sounding measurement (QUASOU)	1: depth known	The depth from chart datum to the bottom is a known value.
	2: depth unknown	The depth from chart datum to the bottom is unknown.
	3: doubtful sounding	A depth that may be less than indicated.
	4: unreliable sounding	A depth that is considered to be an unreliable value.
	5: no bottom found at value shown	Upon investigation the bottom was not found at this depth.
	6: least depth known	The shoalest depth over a feature is of known value.
	7: least depth unknown, safe clearance at value shown	The least depth over a feature is unknown, but there is considered to be safe clearance at this depth.
	8: value reported (not surveyed)	Depth value obtained from a report, but not fully surveyed.
	9: value reported (not confirmed)	Depth value obtained from a report, which it has not been possible to confirm.
	10: maintained depth	The depth at which a channel is kept by human influence, usually by dredging.
	11: not regularly maintained	Depths may be altered by human influence, but will not be routinely maintained.
Scale value one (SCVAL1)	numerical value (25000 -> scale 1:25 000)	The largest scale for the range of survey scale as used in source diagram information.

Attribute	Allowable values	Definitions
Scale value two (SCVAL2)	Numerical value (250000 -> scale 1:250 000)	The smallest scale for the range of survey scale as used in source diagram information.
Sounding distance – minimum (SDISMN)	numerical value (50 for 50 metres or feet)	The minimum spacing of the principal sounding lines of a survey.
Sounding distance – maximum (SDISMX)	numerical value (150 for 150 metres or feet)	The maximum spacing of the principal sounding lines of a survey.
Survey authority (SURATH)	name of the source survey authority	The authority which was responsible for the survey.
Survey end date (SUREND)	CCYYMMDD CCYYMM CCYY	The 'survey date, end' should be encoded using 4 digits for the calendar year (CCYY), 2 digits for the month (MM) (e.g. April = 04) and 2 digits for the day (DD). When no specific month and/or day is required/known, indication of the month and/or the day is omitted. This conforms to ISO 8601: 1988.
Survey start date (SURSTA)	CCYYMMDD CCYYMM CCYY	As for Survey end date above.
Survey type (SURTYP)	1: reconnaissance/sketch survey	A survey made to a lower degree of accuracy and detail than the chosen scale would normally indicate.
	2: controlled survey	A thorough survey usually conducted with reference to guidelines.
	4: examination survey	A survey principally aimed at the investigation of underwater obstructions and dangers.
	5: passage survey	A survey where soundings are acquired by vessels on passage
	6: remotely sensed	A survey where features have been positioned and delimited using remote sensing techniques.
Information (INFORM)	text	Textual information about the object.
Information in national language (NINFOM)	text	Textual information in national language characters.

It should be noted that, as with CATZOC indication, survey reliability information does not provide any indication regarding the stability of the seabed and the possible difference over time between charted bathymetry and actual depths due to a mobile seabed.

6.7 Depth accuracy in relation to charted depth

CATZOC provides a general impression of the quality of the source data that is used to create depth areas bounded by depth contours. A depth area is an area where the charted depths are bounded by a minimum and (possibly) maximum depth value. A depth contour by default is displayed as a solid line; a boundary between deeper and shallower water. The Hydrographic Office may have provided additional information that the contour line is approximate; it will then be displayed as a dashed line.

Several different depth areas may have the same CATZOC value. On the other hand, more than one CATZOC value may be present within a single depth area

The mariner should take note of the vertical accuracy of the charted depth information (soundings, depth contours, depth areas, dredged areas and underwater hazards) in the areas the vessel is planning to transit and take appropriate caution. Table 6-4 provides depth accuracy for a range of depths, based on the depth accuracies for the ZOC categories as defined in table 6-1.

Table 6-4 – Depth accuracy based on CATZOC value

depth	CATZOC					
	A1	A2	B	C	D	U
0	0.5m	1.0m	1.0m	2.0m	>2.0m	unknown
10	0.6m	1.2m	1.2m	2.5m	>2.5m	unknown
20	0.7m	1.4m	1.4m	3.0m	>3.0m	unknown
30	0.8m	1.6m	1.6m	3.5m	>3.5m	unknown
40	0.9m	1.8m	1.8m	4.0m	>4.0m	unknown
50	1.0m	2.0m	2.0m	4.5m	>4.5m	unknown
75	1.3m	2.5m	2.5m	5.8m	>5.8m	unknown
100	1.5m	3.0m	3.0m	7.0m	>7.0m	unknown

However, mariners should note that in ZOC C, D and U, and even possibly ZOC B, undetected (and therefore uncharted) hazards may exist, and these may exceed the depth accuracy of the charted depths.

6.8 ECDIS safety checking function

Since July 2018 all SOLAS vessels of 500GT and upwards are required to be using ENC's created by Hydrographic Offices in type-approved ECDIS equipment. The use of ENC's within ECDIS provides a wide range of advantages; it simplifies voyage planning, allowing easy modification of routes and offers many safety benefits. Routes can be checked for potential dangers based on the safety parameters input by the Mariner. The safety contour defines the safe water the vessel can navigate in based on the depth areas and contours included in the ENC; and the safety depth defines isolated dangers that are located in otherwise "safe" water. During route monitoring it is also possible for the ECDIS to be configured to alarm and indicate on features set by the Mariner, alerting navigators to impending dangerous situations.

IMO Resolution A.893(21) adopted on 25 November 1999 Guidelines for Voyage Planning states that;

'(2.1) All information relevant to the contemplated voyage or passage should be considered. The following items should be taken into account in voyage and passage planning: appropriate scale, accurate and up-to-date charts to be used for the intended voyage or passage, as well as any relevant permanent or temporary notices to mariners and existing radio navigational warnings.'

This clause requires vessels to carry all appropriate scale ENC's for their intended voyage, thus minimizing any effects of generalization and ensuring the ECDIS can alert the Mariner to dangers by using the largest scale data available. IMO Performance Standard for ECDIS (11.4.6) requires;

'An indication should be given to the mariner if, continuing on its present course and speed, over a specified time or distance set by the mariner, own ship will pass closer than a user-specified distance from a danger (e.g. obstruction, wreck, rock) that is shallower than the mariner's safety contour or an aid to navigation.'

The route checking functions built into ECDIS to check and monitor a route for dangers is a fundamental safety benefit for Mariners. Where passage planning is conducted on ECDIS, use of the route checking function is a key component of the overall process of checking the suitability of a planned route and complements the visual check of that route.

The route checking function is dependent upon a number of parameters set by the Mariner as part of setting up the ship's ECDIS for the voyage. These parameters include a vertical accuracy component, resulting in a safety depth setting; and a horizontal accuracy component, which includes both an allowance for the accuracy of the ship's navigation system and a minimum permissible planned distance from dangers. These settings may be changed for different voyages, and even different phases of a voyage, based on the bathymetric data quality information included in the ENC (such as the Category of Zone of Confidence in Data (CATZOC) attribute on the mandatory Quality of Data (M_QUAL) feature). The settings combine to create a route safety region around a vessel's planned track.

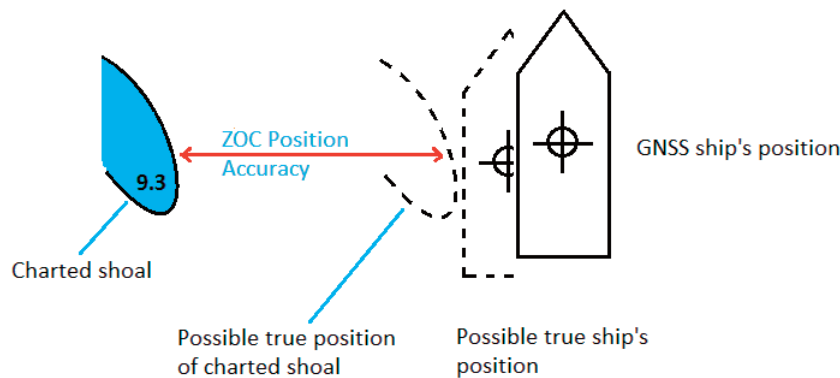

Figure 6-3: *The component parts of determining an appropriate route safety region around a vessel's planned track*

Figure 6-3 shows the minimum considerations when determining what allowance should be made for charted dangers on or near a planned route. These include allowances for the accuracy of the ship's positioning system, and for the accuracy of the chart. The dashed lines indicate the possible worst-case scenario for the Mariner.

Source: AHO.

The ECDIS safety checking function verifies the user-defined safety corridor against the entire chart database in the ECDIS for dangers, not just against the extent of visual point symbols displayed on screen. The ECDIS will graphically identify points along the proposed route that are a danger to the vessel and return a textual list of the same hazards.

ECDIS safety check only verifies data along the user-defined corridor; the width of the corridor is set by the Cross Track Distance (XTD). The safety check will be performed against the largest scale information within the ECDIS system irrespective of the ECDIS display scale. Point features will only be identified as hazards if they fall within the safety zone being checked regardless of the size of the symbol displayed on screen and regardless of the actual extent of the physical feature it represents. Due to the compilation scale of the ENC there could be occasions where the charted point feature may not represent the full extent of the real-world feature. The Mariner must therefore ensure his safety corridor XTD is sufficiently wide enough to identify all navigational dangers along the intended route. Mariners are also required to conduct a thorough visual check of the intended route to complement the automated safety check.

The two following fictitious examples show how a hazardous point feature could be missed if the correct ENC scale charts are not loaded in the ECDIS and route XTD is not adequately set.

Example 1:

In the first example (figure 6-4), the charted position of the 'isolated danger' point feature representing the reef lies about 55m to the east of the planned route and falls within the route safety region. As this point lies within the route safety region set by the Mariner, the ECDIS will detect the reef as a danger close to the planned route and include it in the list of dangers for that leg of the route.

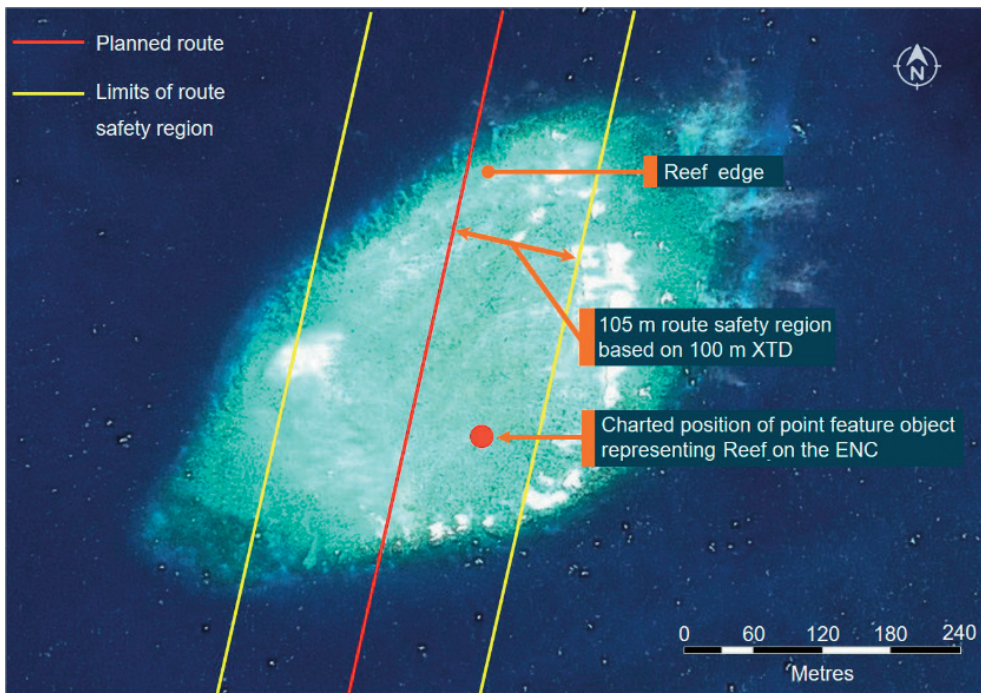

Figure 6-4: Planned route covers the position of the point symbol ⁸

Figure 6-4 shows the planned route and the ECDIS route safety region based on a 100m Cross Track Distance (XTD) near the point position used to represent the reef within the ENC. Note that the charted point position lies within the route safety region and will result in an ECDIS alert.

Source: DigitalGlobe, Esri, modified and annotated by the ATSB and the AHO.

⁸ Scale of figure 6-4 is approximately 1:6000; scale of ENC containing the point symbol is 1:90000.

Example 2:

In the second example (figure 6-5), the planned route lies 55m further to the west. The charted position of the point feature now lies outside the ECDIS route safety zone set by the Mariner. In this case, the ECDIS will not detect the reef as a danger on or close to the planned route. However, the reef still clearly presents a danger to the ship.

In this situation, if the vessel has not taken into account the possibility of isolated reefs within the region, and resultantly extended the XTD to at least account for the horizontal accuracy component of the underlying quality information (CATZOC), there is a possibility the danger could be missed during the visual inspection and the vessel could potentially run aground without the ECDIS indicating the danger on the planned route.

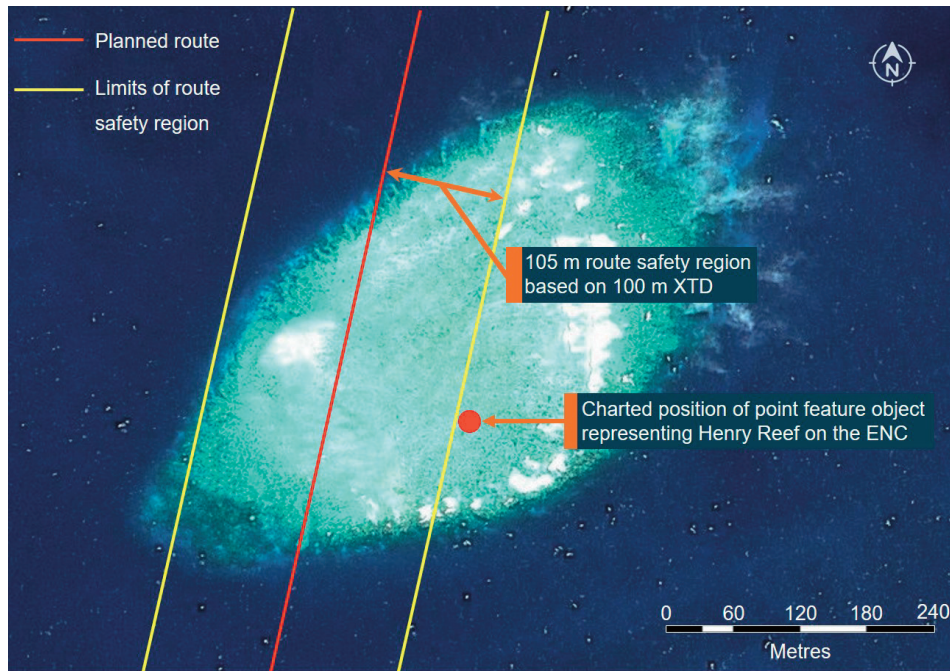

Figure 6-5: *Planned route misses the position of the point symbol*

Figure 6-5 shows a similar planned route and route safety region, 55m further west, near the same point position used to represent the reef within the ENC. The charted point position now lies outside the route safety region and therefore no longer results in an ECDIS alert. However the route still passes over the true reef extent.

Source: DigitalGlobe, Esri, modified and annotated by the ATSB and the AHO.

Given the size of the reef in the examples, it must be stressed that it would typically warrant capture by the cartographer as an area feature within an ENC compiled at the scale of the examples; and only at significantly smaller compilation scales would it be captured as a point feature.

A similar scenario and associated safety implications equally applies to the ECDIS look-ahead function and XTD once the ship is underway and monitoring along the planned route.

6.9 Safety contour

In an ECDIS the default setting for a safety contour is the 30 metre depth contour. When using the default settings of an ECDIS, depth areas deeper than 30 metres will be presented in white (safe water) and areas shallower than 30 metres will be presented in blue (unsafe water). When a safety contour value is entered into the ECDIS, the system will search for the equal or nearest deeper depth contour (if no contour equal to the value entered are included in the ENC) and assign this as the safety contour to be used. White and blue colours will be adjusted accordingly.

In an ENC, the following standard contour lines are generally available:

0, 2m, 5m, 10m, 20m, 30m, 50m, 100m, 200m, 300m, 400m, 500m, 1000m, 2000m, 3000m, 4000m.

The ENC may also contain additional depth contours, for example:

3m, 8m, 15m, 25m, 40m, 75m, 600m, 700m, 800m, 900m.⁸

In addition to the above contours, some Hydrographic Offices are now producing “High Density (HD) ENC”, which may have a contour interval as small as 0.1 metres covering the depth ranges suitable for the draughts of vessels for which the ENC is intended.

6.10 Zones of Confidence symbols in ENCs

There are two validations of Zones of Confidence:

- Assessed
- Unassessed

Areas that have been assessed are symbolized by the number of stars. Areas which have not been assessed are symbolized by the letter U.

⁸ Adapted from S-4 clause B-411

The number of stars is an indication of the CATZOC value:

- 6 stars = A1 (in a triangle)
- 5 stars = A2 (in a triangle)
- 4 stars = B (in a triangle)
- 3 stars = C (in a horizontal bar)
- 2 stars = D (in a horizontal bar)

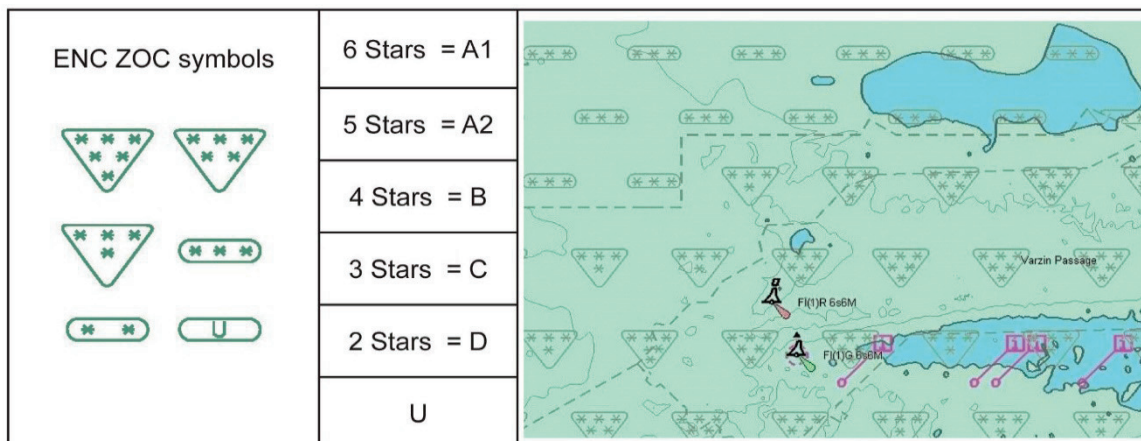

Figure 6-6 – Zones of Confidence symbols, categories and depiction on an ENC

To view the Zones of Confidence symbology, the mariner is required to activate the “information on chart display layer” (or a similar setting, depending on the type of ECDIS used).

The ZOC symbols are placed horizontally across the screen in a regular gridded pattern. The boundary of the CATZOC areas is defined by a dashed line. The ZOC symbol displayed is based on the area defined for each different CATZOC. This means that occasionally only a partial symbol indicating the CATZOC may be depicted, with the symbol being “cut” at the border of adjacent CATZOC areas (thus creating an invalid “composite” symbol, which may be confusing) or at the edge of the ENC cell. This can be seen in figure 6-6, particularly along the boundary separating the ZOC A1 and B areas.

This kind of symbology tends to clutter the screen, therefore during execution of a voyage mariners will most likely de-activate this setting. However, when planning a new route or changing an existing route whilst en-route, mariners are recommended to activate the CATZOC display and use the information provided to support their decision making process before accepting the new route in the ECDIS system.

Quick Reference:

- 5 stars or more = high accuracy depth information area.
- 4 stars = medium accuracy depth information area.
- 3 stars or less = poor accuracy depth information area.
- U = unassessed, take appropriate caution.

6.11 Impact of ZOC categories upon mariners

Put in simple terms, mariners should be able to navigate with confidence in areas with ZOC A1 and A2 classifications. It is possible, but unlikely, that an uncharted danger affecting surface navigation exists in ZOC B areas. In ZOC C areas mariners should exercise caution since hazardous uncharted features may be expected, particularly in or near reef and rocky areas. A very high degree of caution is required for areas assessed as ZOC D, as these contain either very sparse data or may not have been surveyed at all. Finally, it is good practice to treat ZOC U areas with the same degree of caution as ZOC D areas.

To put this in perspective, table 6-1 is an overall analysis of over 14 million square kilometres of coastal ENC⁹ from 32 nations:

Table 6-1 – Coverage by ZOC category - analysis

ZOC category	% area of English Channel	% area of Singapore & Malacca Straits	% area of world's coastal ENC (32 nations)	Confidence
A1 (6 stars)	12.4%	1.4%	2.5%	Good
A2 (5 stars)	7.1%	0.2%	3.0%	Good
B (4 stars)	43.5%	2.5%	38.5%	Medium
C (3 stars)	21.6%	76.2%	27.8%	Poor
D (2 stars)	12.4%	1.1%	12.5%	Poor
Unassessed (U)	3.0%	18.5%	15.7%	Poor

⁹ From Navigation Purpose 3 and 4 ENC, covering 14,218,244 SQ KM. World and English Channel figures are from 2020; Singapore and Malacca Straits figures are from 2015. The analysis did not include ports.

Section 7 Distribution of ENC's and RNC's

7.1 Updating ENC's

In principle the generation and distribution of regular updates for ENC's follows a similar organizational structure to the production and distribution of ENC's. The frequency of updates (including permanent updates and updates equivalent to the content of Temporary (T) and Preliminary (P) paper chart Notices to Mariners) is normally synchronised with the chart corrections promulgated by national Notice to Mariners for the affected sea areas.

Updates may reach a ship via different ways depending upon the capabilities of the ENC service provider and the communication facilities onboard:

- On data distribution media, for example CD;
- As an e-mail attachment via SATCOM; and
- As a broadcast message via SATCOM plus additional communication hardware.

7.2 ENC Distribution

The provision of a timely, reliable, worldwide and uniform ENC data distribution service is a major organizational challenge and the IHO developed the WEND (World-wide ENC Database) concept to meet these requirements. The purpose of WEND is to ensure a world-wide consistent level of high-quality, updated official ENC's through integrated services that support chart carriage requirements of SOLAS Chapter V, and the requirements of the IMO Performance Standards for ECDIS. The WEND Principles are included as Resolution 1/1997 (as amended) in IHO publication M-3 (www.iho.int > *Standards & Publications* > *M-3*). The WEND Working Group (WENDWG) has also produced "Guidelines for the Implementation of the WEND Principles" which are available from the WENDWG document page (<https://iho.int/en/wendwg>). WEND consists of two components:

- A charter that describes the principles governing cooperation between the worlds Hydrographic Offices producing ENC's. Principles include:
 - The organization responsible for the primary charting of an area is responsible for ENC production in that area;
 - The relevant IHO standards, especially S-57 must be followed; and
 - The rules of a recognised work quality assurance system (such as ISO 9000) should be applied to ENC production.
- A conceptual schema describing a network of Regional Electronic Chart Co-ordinating Centres (RENCs), where:
 - Each RENC takes responsibility in its area for the collation of ENC's and updates for the region;
 - Each RENC can offer an identical global dataset for ECDIS through the exchange of the regional datasets and their updates between all the RENCs, and
 - RENCs act as a wholesale outlet for ENC's. RENCs supply ENC's to commercial user service providers who - rather like paper chart distribution - tailor individual sets of chart data for the special needs of a shipping company or a particular ship.
- Producer Member States are encouraged to distribute their ENC's through a RENC. Those not opting to join a RENC should make appropriate arrangements to ensure that their ENC's meet WEND requirements for consistency and quality and are widely distributed.

To date, two RENCs – PRIMAR, based in Norway; and IC-ENC, based in the United Kingdom, Australia and the Americas, are in operation. The RENC model has yet to be fully adopted by all ENC producing nations. A number of nations still distribute their ENC's individually either through individually appointed chart data suppliers or directly rather than through RENCs.

Because ENC's might be subject to unauthorised amendment or illegal copying, the IHO has adopted S-63 – “*The IHO Data Protection Scheme*”. This provides a standard authentication and encryption for ENC's. S-63 defines the technical details of the encryption method and the operating procedures for the RENC and ENC distributors. It also provides specifications that allow ECDIS manufacturers (OEMs) to build systems that can authenticate and decrypt S-63 ENC's.

7.3 What is a SENC?

In order to get efficient data structures that facilitate the rapid display of ENC data, most ECDIS convert each ENC dataset from S-57 into an internal machine-language format called SENC or System ENC – which is optimised for chart image creating routines. Most ECDIS software manufacturers have their own SENC format.

7.4 SENC Delivery

In order to take advantage of the efficiencies of delivering ENC data in a SENC format, the IHO has authorised an optional distribution mechanism called SENC delivery. This is in addition to the standard distribution of ENC in S-57 format. In this case, a RENC delivers the S-57 based ENC's to an authorized chart data distributor who then performs an ENC-to-SENC conversion (that otherwise would take place inside the ECDIS), and delivers the resultant SENC to the end user.

However, it is up to individual Hydrographic Offices to decide whether they wish to allow the ENC's for their waters to be distributed in SENC format in addition to S-57. Not all Hydrographic Offices allow their ENC's to be delivered by distributors as SENC's.

7.5 Official and Unofficial Data

An ECDIS can determine if data is from either an ENC or a private source by interrogating the Agency Code (a two character combination which is unique for any data producer) embedded in the data.

Using this code an ECDIS will warn mariners that they must navigate with an official up to date paper chart if data from a private source is in use. The ECDIS will show a warning on the ECDIS screen:

«No Official Data -Refer to paper chart»

7.6 Use of ENC's in ECS

Many ECS are able to use ENC's. However, because an ECS, by definition, is not type-approved as meeting the ECDIS performance standards, the use of ENC's in an ECS does not satisfy the ECDIS carriage requirements of SOLAS.

7.7 Raster Navigational Charts (RNC's)

General principles

RNC's are digital copies of paper charts conforming to IHO publication S-61 - *Product Specifications for Raster Navigational Chart (RNC)*. RNC's are issued by, or on the authority of a national Hydrographic Office.

When displayed on an ECDIS screen RNCs appear as a facsimile of the paper chart however, they contain significant metadata to ensure that they have a certain minimum functionality; such as a geo-referencing mechanism that allows geographic positions to be applied to and extracted from the chart, automatic updating of the RNC from digital files (and the ability to show the state of correction), and the display of the RNC in day or night colours.

An RNC is a digital copy of the current paper chart. As such the chart content cannot be analysed by a computer program to trigger alarms and warnings automatically as is the case with a vector chart; however, some alarm and warning functions can be achieved by manual user input to the ECDIS.

7.8 RNC data format and production

RNCs are normally produced by digitally scanning the stable reprostat used to make a paper chart, or direct conversion of a completed compilation of a paper chart in a digital chart production system to a raster format. Unlike ENC's there can be more than one format for RNCs. The main RNC formats are:

- BSB (used by USA, Canada, Cuba and Argentina); and
- HCRF (used by UK and New Zealand).

7.9 RNC Display

- The display of RNCs is limited by the resolution at which they were scanned. Excessive zooming in or out of the image seriously degrades the clarity of the image (see figure 7-1). When the user wants to see a representation of a geographic area in greater detail, then just like a paper chart, a larger scale RNC should be selected (if it exists);
- Orientation of the Raster Chart Display System (RCDS) display to other than north-up (for example course-up or route-up), may affect the readability of chart text and symbols;
- RNCs incorporate very similar colour palettes to the day/night colours used by ENC's. It is mandatory for ECDIS with an RCDS capability to provide the appropriate colour palettes for RNCs;
- RNCs are treated as individual charts (not seamless like ENC's). However, it is possible for ECDIS to automatically load an adjoining chart, based on the meta data provided;
- ARPA radar targets can be overlaid onto an RNC. It is also possible for a radar video image to be scaled to fit an RNC. Scaling an RNC to fit a radar video image is inappropriate as this is likely to result in a degraded chart image; and
- RNCs include significant meta data to allow an ECDIS to make maximum use of the image. For example chart notes and tide panels may be accessed directly in RCDS mode rather than the user having to scroll to the appropriate area of the chart.

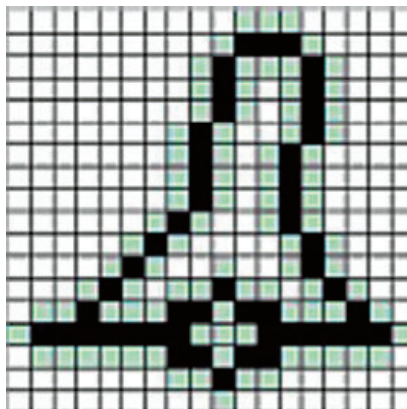
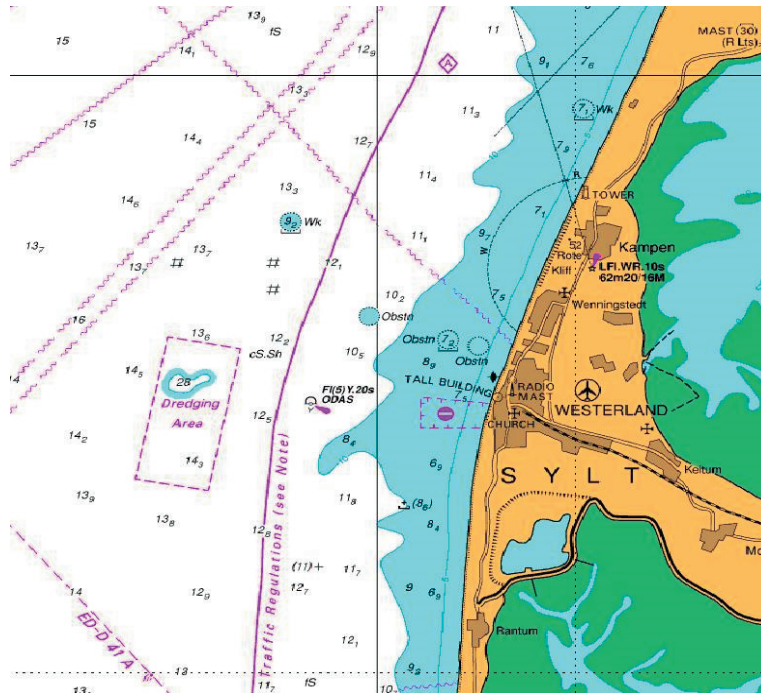

Figure 7-1 "Over-zoomed" symbol on a raster chart

The image of an RNC retains the horizontal datum of the paper chart from which the RNC has been derived. However, the geo-referencing of the RNC can include an adjustment to account for the use of GNSS and the WGS 84 datum. Mariners should understand how the horizontal datum of the original chart relates to the datum used by the ships position fixing system. In some instances, this will appear as an apparent shift in geographical position. (Any differences will be most noticeable at grid intersections and during route monitoring). Where the difference between the local horizontal datum and WGS 84 is known, the adjustment should be automatically applied by the ECDIS. If the horizontal datum of the paper chart from which the RNC is produced is not known then it is not possible to relate GNSS positions accurately to the RNC; IMO SN/Circ.255 has been issued to alert users to this problem.

Below are illustrated Day and Night colour schemes of a RNC:



RNC Display, day

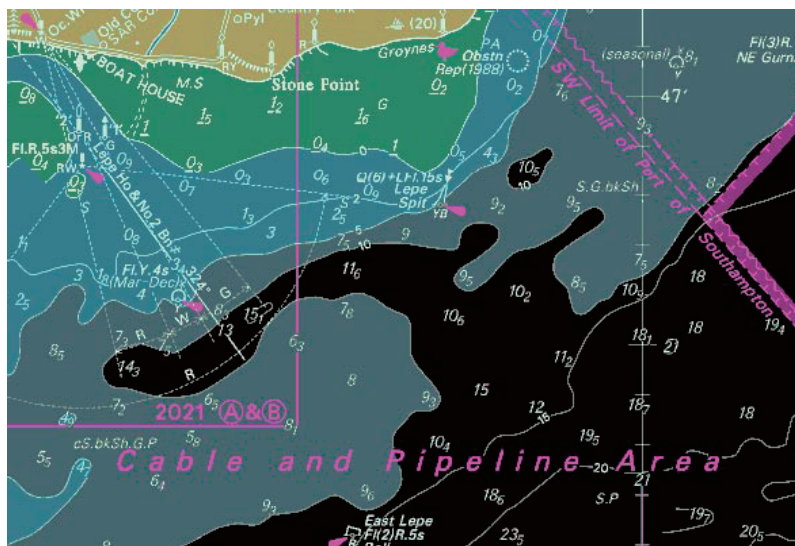

RNC Display, night

7.10 RNC updating

- RNC updates can be supplied as complete refreshed images or as patches (tiles or areas) that the ECDIS can superimpose on the original RNC. The latter method is normally used as this minimises the amount of data to be provided;
- Updates are provided in line with those made available via the Notices to Mariners system for the equivalent paper chart; and
- Most RNC services currently rely on CD as the transfer media; however electronic courier services are now being established to allow mariners to download selected chart updates.

7.11 Private Chart Data

Privately produced chart data may be provided in either vector or raster formats and superficially might seem similar to official chart data. However there are important differences in the type and quality of data being sold and while many companies take care in the production of electronic chart data to ensure both completeness and accuracy, this cannot be assumed for all.

Private chart data cannot be updated with the same regularity as official data. The private chart data suppliers normally base their products on official charts and data (supplied by HO's under licence). This means that the updating of their charts depends on the availability of the updated official chart product. Consequently there is a delay, sometimes considerable, between the promulgation of the updates for the official charts and the release of updates for private chart data.

Chart data published by private companies is not quality controlled or assured by a Government organization; therefore the product liability is entirely the responsibility of the producing company.

In 2003 ISO published a specific standard (ISO 19379:2003) for the compilation of private chart data for use in Electronic Chart System (ECS); this standard was produced on the initiative of the private chart data industry. ISO 19379 applies to both private vector charts and to private raster charts. It includes test methods for the production of an ECS database and addresses the elements of the database relevant to safety of navigation including content, quality and updating. It also provides guidance on the production and testing of an ECS database. It does not cover the methods and techniques required for database design and development, nor does it address specific quality management procedures. Private chart data, regardless of the format in which it is supplied to the market or any ISO certification, does not meet the requirements specified by the IMO Performance Standards for ECDIS and thus does not meet the chart carriage requirements.

In contrast to ENC's and RNC's many proprietary formats are used. Consequently, chart data from different manufacturers are often incompatible with each other – and so are the ECS which make use of them.

Section 8 IHO ECDIS & ENC cyber security

8.1 Introduction

The benefits of digitalisation rely on interconnected systems which can safely transfer information to deliver operational optimisation, cost savings and safety improvements.

The maritime industry is going through a significant change, driven by the increased availability of satellite communications. Technological developments previously unachievable ten years ago are rapidly becoming possible. With increased digital interconnectivity comes the increased risk of cyber-attack, and vessels once considered safe at sea—can no longer assume they will not be a target of cybercriminals.

The goal of the IMO maritime cyber risk management is to support safe and secure shipping operationally resilient to cyber risks. MSC.428(98) states from 1 January 2021, all vessels must ensure their Safety Management Systems (SMS) appropriately address cyber risks.

Vessels must continuously update ENC data used in ECDIS with changes promulgated by the Hydrographic Office to remain carriage compliant as required by SOLAS. This continual process of updating ENCs presents a permanent and persistent vulnerability, which must be managed by shipping companies in their SMS.

This guideline prepared by the IHO seeks to support Shipping companies and Mariners in mitigating their exposure to cyber risk when using ENCs in ECDIS.

The key to limiting risk is confirming the data going into the ECDIS comes from a trusted source. It is possible to reduce risk by ensuring the ENC service purchased for the vessel comes from a reputable ENC service provider, who will transfer the data in an encrypted form.

Most commercial ENC services use the IHO data protection scheme S-63 to protect the data. S-63 provides a method for ensuring vessels can authenticate data received in the ECDIS against a known and trusted list of providers. All ECDIS are tested during type approval to ensure they can load and decrypt S-63.

While all ECDIS can load and display ENC data in its native S-57 format, it offers no cyber security protection and is not advised. Several ENC service providers convert the data on shore to the proprietary data format of the ECDIS.

These are called SENC services and are specified to be protected by a security that provides equivalent or greater protections than IHO S-63.

8.2 Glossary of terms

ENC – Electronic Navigational Chart

ECDIS – Electronic Chart Display & Information System

SENC – System Electronic Navigational Chart

OEM – Original Equipment Manufacturer

S-63 – IHO Data Protection (encryption) Scheme for ENC against unauthorised amendment or illegal copying

8.3 References

1. MSC.428(98), 16 June 2017, Maritime Cyber Risk Management in Safety Management System (SMS)
2. MSC-FAL.1/Circ.3, 5 July 2017, Guidelines on Maritime Cyber Risk Management
3. Bimco, The Guidelines on Cyber Security Onboard Ships, version 4
4. IEC 61162-450
5. IEC 61162-460

8.4 Guideline objectives

The document uses the established IMO Cyber Risk Management categories; identify, protect, detect, respond and recover.

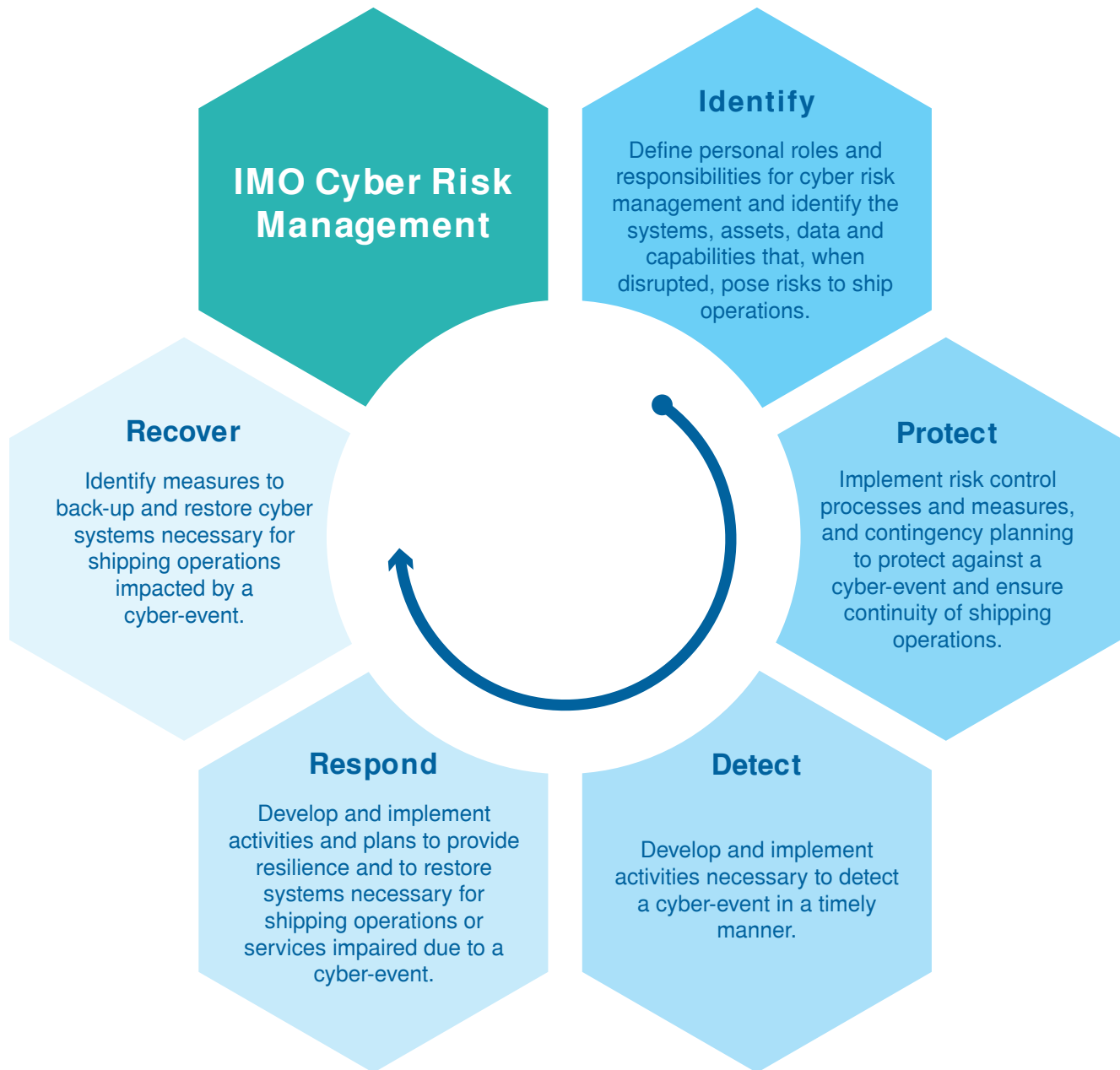

Figure 8-1

8.5 Scope of applicability

The two principal data transfer methods used to load ENC data and cell permits into ECDIS are covered by this guideline:

1. Removable media
2. Bridge networks

(Navigation and radio communication systems, covered by the following standards IEC 61162-460 or IEC 63154 can be used)

8.6 Transferring ENC data and cell permits via removable media

Cyber Risk Management categories	Issues / considerations
1. Identify	<ul style="list-style-type: none"> › ECDIS › USB/DVD › Communication PC/back of bridge › Lack of cyber security training and awareness › Vessel's network › Potential threat actors › Transfer of data and permits to ECDIS via USB / DVD › Lack of Network boundaries and segmentation › ECDIS operating system › Outdated or lack of antivirus on ECDIS › Inadequate access controls
2. Protect	<ul style="list-style-type: none"> › Create a risk assessment matrix and quantify potential impacts based on the severity and likelihood of each cyber-attack scenario
3. Detect	<ul style="list-style-type: none"> › Use approved ENC distributors that secure data transfer in S-63 or an equivalent security scheme › Scan physical media or USB with antivirus for malware or ransomware after each use › Add access controls to the individual systems
4. Respond	<ul style="list-style-type: none"> › Develop a response plan covering relevant contingencies
5. Recover	<ul style="list-style-type: none"> › Preparation › Detection and analysis › Containment and eradication › Post-incident recovery

Table 8-1

8.7 Identifying threats via removable media

The first stage of becoming more cyber secure is identifying the potential threat vectors for malicious code to infiltrate the vessel's networks, systems or data sources. The internal and external threats to the vessel's ECDIS need careful examination, with interdependencies on different systems and their data flows. Vessels must consider the resources involved in the management of the ECDIS, the operation/governance documents and the crew's roles and responsibilities.

8.7.1 USB/DVD

An ECDIS's ability to accept USB and DVD media presents a severe threat vector for threat actors to install malicious software onto the system. USBs and DVDs can auto-launch and transfer spyware and ransomware content onto the ECDIS. The threat level can heighten if the physical media's source is unknown or the vessel has not enforced strict protocol and physical barriers to the upload media.

8.7.2 ECDIS

The ECDIS and its underlying operating system could be a potential threat. Within the market today, many ECDIS still run on Windows XP or older operating systems, which have greater-known vulnerabilities and are more open to malicious attacks. ECDIS with newer operating systems can have regular updates, patches and service packs applied to mitigate the latest known security threats.

8.7.3 Communication/back-of-bridge system

Vessels commonly use a back-of-bridge system connected to an external network to receive navigational data updates and route planning. The back-of-bridge system can be a primary target for malicious actors to use as a front door for ingesting viruses for onward transit onto an ECDIS via physical media.

8.7.4 Vessel network

ECDIS can update via a ship's external network and physical media. Whilst threats regarding the human handling of media are not applicable, other potential threats emerge. Networks not secured via gateways, firewalls and encryption are an ideal target. If a vessel's network is breached it can have catastrophic effects on other vessel systems connected to the same network. Attackers can flood the network with excessive data traffic to degrade the service in a denial-of-service attack if the vessel does not implement monitoring and threat detection.

8.7.5 Potential threat actors

A vessel relies on external data and services to ensure safe navigation on the latest up-to-date data. It is also crucial to ensure crew members follow strict protocol and have no potential motives to sabotage the vessel's safety. Spear phishing emails, fake websites, redirects and cross-site scripting pose a significant security threat to the secure transfer of legitimate data onto a vessel's network or back of bridge before it is loaded onto an ECDIS.

8.7.6 Lack of cyber security training and awareness

The vessel's crew and cyber security awareness must be assessed and continuously managed. As new physical and technical attack vectors emerge and evolve, cyber security awareness will decline, and the potential cyber security risk will heighten. If there is a lack of vessel protocol, training and documentation, responding to a cyber-attack will likely take longer with catastrophic effects.

8.7.7 Identifying vulnerabilities

Inventory of CBSs (Computer Based Systems) and networks

Every vessel should create an inventory mapping the networks, the data flows, and the hardware and software used on board the vessel. This inventory should be a living document. The vessel must continuously update it following any modifications to applications, operating systems and firmware.

Having an up-to-date holistic overview of the vessel's data ecosystem allows for easy analysis of the potential threats and helps highlight areas that need strengthening or risk being an easy target for attackers. Good inventories should list IP addresses, port numbers and all the necessary information that could be drawn upon to halt an attack or used in recovering from one.

When creating an inventory, the vessel must consult stakeholders from the shipping company, ship designer, System Integrator and Classification Society to help build a detailed system map.

Inventories pose a potential security threat should they get into the wrong hands. They must be physically and digitally secured and only accessed by necessary personnel.

8.7.8 Transferring data and permits to ECDIS via USB/DVD

For up-to-date navigation, mariners are required to load permit files and exchange sets into their ECDIS on a frequent basis. Whilst most of the exchange set information is encrypted and contains digital signature files, unsigned ancillary files still present a significant threat, which could be modified or replaced with malicious code. Furthermore, there is an IMO/IHO requirement for ECDIS to be able to load unencrypted data that presents another threat vector for threat actors to load malicious software onto the ECDIS system. With an increase in the further dissemination of open-source data which can be loaded into an ECDIS, it should be highlighted that this can pose a significant security risk as it can still interfere with the official encrypted data.

Vessels still use CDs and DVDs to update their ECDIS with the latest weekly data. Distributors and shipping companies often write these before sending them via a courier. Threat actors can transfer malicious data onto the disk or switch the disk during transit.

Whatever the update method, if removable media devices are used, they should be checked for malware using up-to-date antivirus software and validated by digital signatures and watermarks before connecting to the system.

8.7.9 ECDIS operating system

Many ECDIS are running on Windows XP or other legacy systems with well-known security and vulnerability issues. Vessels should ensure their ECDIS have patches installed regularly in a maintenance mode to address security vulnerabilities and other bugs or improve operating systems or applications. Vessels should ensure they back up files and systems to recover them if attacked or if they experience database corruption.

The vessel's ECDIS user policy should adopt a principle of Least Functionality, which provides only essential capabilities and prohibits/restricts the use of non-essential functions, ports, protocols and services that are disabled or otherwise prohibited. The ECDIS should be used for primary navigational use only, and all other data validation and preparation should be carried out on a secure back-of-bridge system/network.

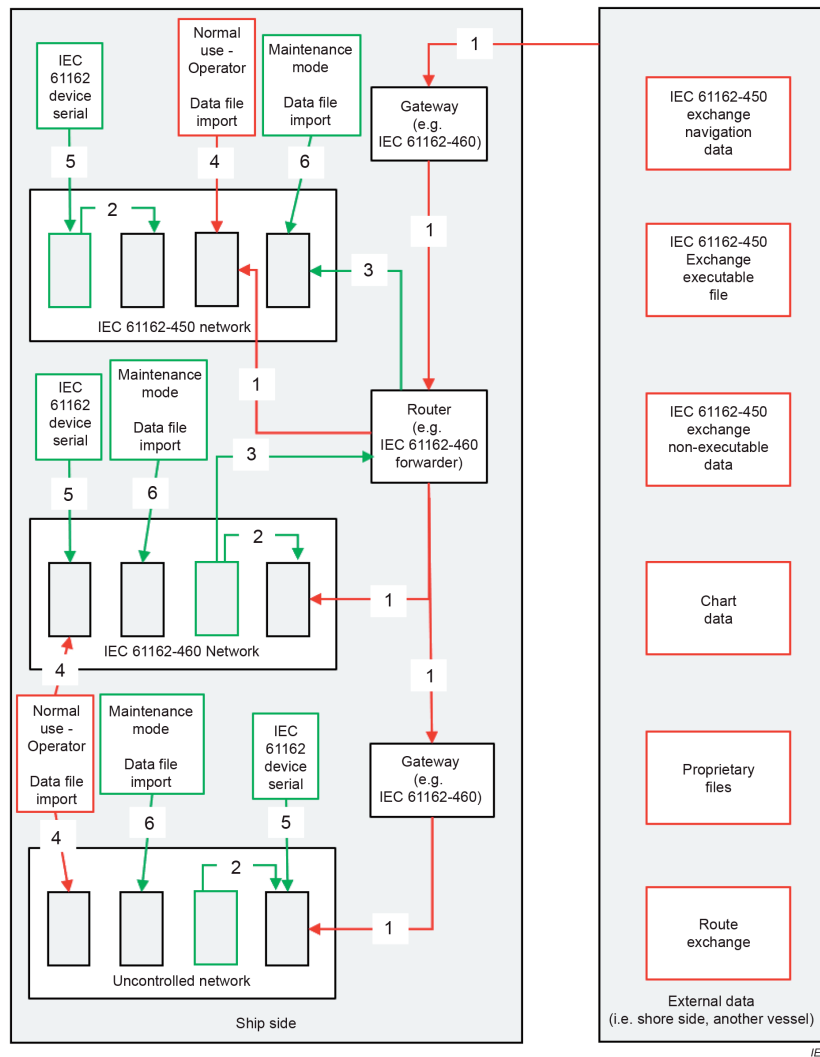

Figure 8-2

8.7.10 Outdated or lack of antivirus on ECDIS

ECDIS and back-of-bridge systems should be protected against malicious code such as viruses, worms, trojan horses, spyware, etc. A virus can easily evade and hide within the ECDIS whilst self-replicating, spreading and acting maliciously, performing actions that affect the system's navigational performance.

Antivirus, antimalware and antispam software will create a shield to block known threat vectors into the system and remove any viruses already detected within the system hardware.

Common means for virus infiltration into or via a back-of-bridge setup are electronic mail, electronic mail attachments, websites, removable media, PDF documents, web services, network connections and already infected networks.

If ECDIS cannot run or have installed antivirus and antimalware software, a vessel must implement malware protection through operational procedures, physical safeguards, or according to the manufacturer's recommendations.

8.7.11 Inadequate access controls

The ECDIS, back-of-bridge system and network on the vessel should provide physical and digital measures to limit the ability to interact with the system itself. Access controls and user groups should be implemented to restrict access to system resources or gain knowledge of essential control system components and functions.

Access to the vessel's onboard networks and access points should only be allowed to authorised personnel, under supervision or according to documented procedures, e.g., for maintenance. Other networks should be used for non-navigational requirements such as printing documents or accessing external uncontrolled networks like the internet.

Cyber Risk Management categories	Issues / considerations
1. Identify	<ul style="list-style-type: none"> › ECDIS › USB/DVD › Communication PC/back of bridge › Lack of cyber security training and awareness › Vessel's network › Potential threat actors › Transfer of data and permits to ECDIS via USB / DVD › Lack of Network boundaries and segmentation › ECDIS operating system › Outdated or lack of antivirus on ECDIS › Inadequate access controls
2. Protect	<ul style="list-style-type: none"> › Use an authorised ENC distributor where data contains certificates. › Ensure antivirus is up to date on back-of-bridge or systems connected to the ECDIS network › Use a 460 Network Gateway › Pre-validation of data within the distributor's system › Develop an incident response plan, checklists and drills for a possible attack, including a backup arrangement of ECDIS
3. Detect (one in isolation may not indicate a cyber-attack)	<ul style="list-style-type: none"> › Check the sender's URL and network addresses/whitelist › Monitor ECDIS behaviour for abnormalities › Monitor system performance and speed › Regularly check alerts and notifications from antivirus › Question if your system likely to be infected based on network connectivity and the amount of use › Add access controls to individual systems
4. Respond	<ul style="list-style-type: none"> › Ensure you have informed the vessel master of a possible cyber issue as soon as it occurs › Log the incident as soon as possible › Ensure the safety of the crew and vessel › Enact a contingency plan covering relevant contingencies, and ensure the vessel strictly follows a response plan for cyber-attack › If possible, add an extra watch on the vessel while the vessel undergoes a response plan › Check redundancy systems – backup ECDIS, back-of-bridge, paper chart etc › Collect evidence of the attack (screenshots or videos) to aid response plans and better respond to future incidents › Contact the shipping company to inform them of onward communication with coastguards and discuss what assistance they can provide › Inform shipping companies and distributors, describing symptoms, severity, operations on the bridge and operational contexts › Inform coastal authorities VTS etc so nearby they can alert nearby traffic to the dangers › As a last resort, disconnect network cables and Wi-Fi › Communications of demand – In a ransomware scenario, listen to demands and stall before deciding how to proceed › Ensure communication with the entire crew

Cyber Risk Management categories	Issues / considerations
5. Recover	<ul style="list-style-type: none"> › Safety first: navigate to a port where a professional can access the system › If required, allow a professional to complete an uninstall/reinstall of ECDIS software › Communicate with the system integrator responsible for the installation regarding the security vulnerability › Ensure a professional returns the ECDIS to a safe state and not the vessel's normal state › Containment and eradication – Analyse causes and ensure a professional removes any threats from the ECDIS and network components › Evaluate what went well and requires improvement › Ensure you record the incident and the experience in case of future incidents

Table 8-2

8.8 Identifying threats to your network

Lack of network boundaries and segmentation

Networks that connect to the ECDIS need to be managed and have security zones established by your system integrator and shipping company to ensure viruses and malicious data packets do not penetrate the ECDIS or other vessel systems.

Well-defined security policies and capabilities need to be established to only allow explicit traffic across the different zones of the network to the ECDIS. Ensure your system integrator has installed 460-Gateways, Firewalls, Routers and isolated (air-gaped) networks to manage the vessel's connection with an external network.

Using Intrusion Prevention Systems (IPS) - Network traffic can be monitored. Using 460-Gateways, Forwarders and DMZs (demilitarized zones) it is more difficult for an attacker to perpetrate an attack throughout the entire network and reach the ECDIS. Segmentation can help reduce the potential attack surface, prevent attackers from achieving lateral movement through systems and improve network performance.

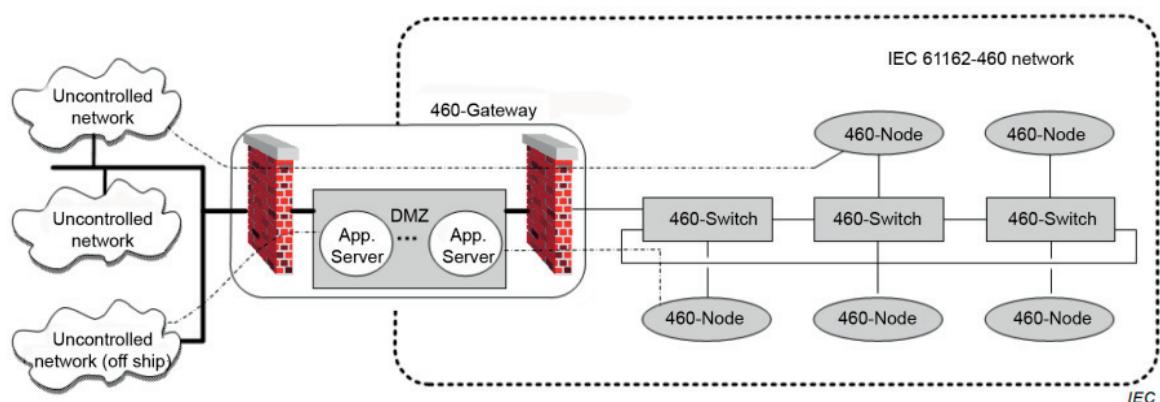

Figure 8-3

Use of unverified applications running on other back-of-bridge systems connected to the network

The vessel should ensure the use of third parties or applications not documented or on the CBS inventory is prohibited where possible. The crew's personal devices must connect to a separate network of the vessels to reduce the risk of an attack on the critical underlying network of the vessel. Attackers may attempt to access onboard systems through the weakest vulnerability loopholes, which is often a third-party application with known security vulnerabilities.

8.9 Protect

Use an authorised ENC distributor where data contains certificates

When receiving data via a network, it is important to use a data provider who adds signatures to their data. Data with a signature prevents a malicious actor from modifying an original file via its transfer into the vessel's ECDIS. If the ECDIS cannot validate the signature file, it will prevent it from being loaded into the ECDIS, significantly reducing the chance of a malicious attack on your systems. Some data producers make their ENCs available unencrypted. However, it may be prudent to source these ENCs via a data server where signatures are provided alongside the data.

Using an ENC distributor to provide ENCs over a network can also reduce the cyber security risk due to their ability to pre-validate the data sent. Distributor systems can scan content for malicious files or suspicious content that could present a risk to your networked ECDIS. Having a distributor in the data transfer flowline to the ECDIS adds another layer of resilience and provides a point of contact for any questions or concerns with the data sent.

Develop a contingency plan

Develop an incident response plan should a cyber attack on the vessel's network or ECDIS occur. This response plan should contain checklists of practical actions the crew can take to detect, respond and limit the consequences of cyber incidents. The plan can help inform the crew of how to implement breakpoints of compromised equipment, prioritise response options, detect signs of what to look for when being attacked and how to operate during an attack without using infected networks or hardware.

8.10 Detect

Check URL and network addresses of data sender/whitelist

If your ECDIS connects via a network, ensure you whitelist the connection URL so your ECDIS trusts only that network path. Where possible, the network should be configured so that only trusted data sources can access the network. Ensure network addresses are constantly reviewed and validated with your data provider should a new or modification to an existing network address be required.

Monitor ECDIS behaviour for abnormalities

You can look for several symptoms to help detect an attack on a networked ECDIS; these include:

- › Any screen flickering abnormalities or unresponsive user interfaces
- › Unexplained system reboots
- › Unstable PC temperature
- › Abnormal system noise from fans and hard drives
- › Inconsistent ECDIS timing with the GPS; an attacker could spoof your position using GPS timing or be sending the ECDIS incorrect packets of positional data from your GPS
- › Abnormal system performance
- › Abnormal system speed: if you experience a noticeable degradation in speed and system performance, you could be under a cyber-attack; your ECDIS may be running malicious software in the background

If you notice one or more of these symptoms above, you should stop what you are doing, notify the master/crew of the vessel take caution and ascertain if you are under attack before deciding to continue operation.

8.10.1 Check alerts and notifications from antivirus regularly

Ensure your system integrator or shipping company keeps your antivirus software up to date. If the vessel's approved ECDIS cannot run an antivirus, ensure the back-of-bridge system or any other systems connected to the same network as the ECDIS utilise it.

Vessels should run antivirus checks on the network frequently; this improves your chances of detecting and removing malicious files before they spread and take effect.

8.10.2 Check network connectivity and the amount of use

Ensure your system integrator or shipping company keeps your antivirus software up to date. If the vessel type approved ECDIS cannot run an antivirus, then ensure the back-of-bridge system or any other systems connected to the same network as the ECDIS.

Antivirus checks should be run frequently on the ship's network, to a schedule and reviewed to heighten the chances of detecting and removing malicious files before they spread and take effect.

8.10.3 *How likely is your system to be infected based on network connectivity and amount of use?*

When detecting a network-based cyber-attack, it is prudent to constantly evaluate the network's use and how much data the ECDIS has ingested. If frequent transfer of multiple files has occurred, there is a heightened risk of a cyber-attack. After heavy network use for a prolonged period, it would be wise to run a virus check or seek a professional system check by a system integrator or technician to run a health check on your system.

8.11 Respond

When responding to a cyber-attack ensure the master of the vessel and all crew members are informed, and the incident is logged in the vessel's SMS. Enact the contingency plan and ensure all crew members are safe from immediate threats. Where the vessel's ECDIS could be compromised and mislead the navigator, you could add an extra watch to ensure the vessel stays clear of potential dangers and other traffic.

When it is safe to do so, and where possible, use the redundant navigation system such as a secondary ECDIS or paper chart to base navigational decisions on. Whilst under a cyber-attack try to obtain evidence of the observed behaviours and abnormality via system screenshots or via phones.

It may be prudent to have a different update regime for the redundant navigation system and not synchronise the same data across multiple navigational units simultaneously. This practice will help mitigate a compromised main ECDIS from affecting other redundant backup systems and will become particularly relevant as mariners move to event-driven updates via satellite communications.

Whilst under attack, contact the coastal authority for the area, your shipping company and the distributor of the vessel's data. By informing all parties, the coastal authority can forewarn vessels in the area via radio warnings and may be able to aid and protect the vessel and ensure it stays safe. Whilst trying to resolve the threat, record all operations carried out and any observations documented. If all attempts to overcome the attack on the network have failed, then it might be applicable to disconnect all systems from the compromised network. Throughout the attack, ensure all vessel crew are informed of developments and decisions made.

8.12 Recover

When it is safe to do so, and you are confident your network has been attacked, you must safely navigate to the port for your systems to be cleaned of the cyber threat/virus.

When travelling to the nearest port, you must enact your contingency plan and use backup ECDIS or hardware you know has not been compromised. Once in port, the vessel must contact the ECDIS OEM, the system integrator and vessel technicians to analyse the network and connected systems to remove the malicious files and address the underlying vulnerability.

Where applicable, it might be required to completely uninstall operating software and applications connected to the network to ensure no vulnerabilities or attack vectors remain.

Whilst the systems and ECDIS are restored, the OEM or system integrator should return it to its original state. Where vulnerabilities or threats are discovered by poor vessel practice, you must share these with the crew and address them before onward navigation.

Once the incident is resolved, evaluate what went well and where you can improve the contingency plans. Ensure you record the incident in the vessel's SMS and document all experiences for future incidents.

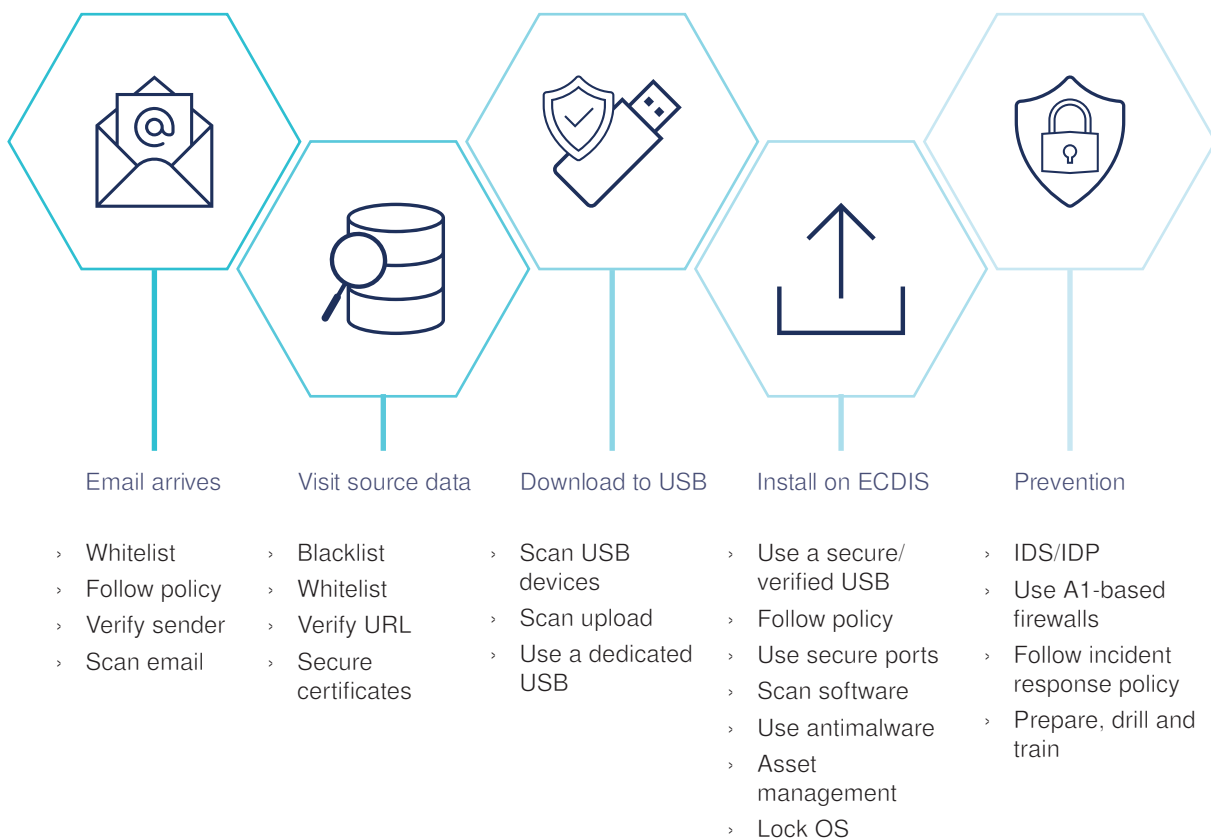

Checklist for the creation of a response plan for an ECDIS using USB or removable media

Action	Assignee			Signed	Approved	Date last issued
	System Integrator	Ship Company	Vessel			
Use an approved ENC chart distributor that uses either the IHO data protection scheme S-63 or a type-approved SENC delivery method to secure the data						
Ensure the crew have adequate access to cyber security training						
Change onboard default equipment and software passwords monthly or if compromised						
Install virus-checking software on board						
Ensure virus-checking software remains up to date with the latest software releases						
Be vigilant of spam emails and attached files						
Scan removable USB devices before transferring digital files from a communication PC to the ECDIS						
Only use the dedicated USB device to download and transfer ENC data and permits to ECDIS						
Clearly label the USB device to mark it as dedicated to transferring ENC data and permits						
Do not use the dedicated USB device for anything else than data download/import to ECDIS						
Do not store digital files on this device						
Do not leave the dedicated USB device unattended						
Reformat the dedicated USB device after use						
Before transferring data to the ECDIS via USB pun permits and ENC data through antivirus and antimalware tools						
Do not allow crew's personal devices to be connected to ECDIS						

Action	Assignee			Signed	Approved	Date last issued
	System Integrator	Ship Company	Vessel			
Keep ECDIS updated to latest IHO standards						
Keep ECDIS updated for the latest software releases as recommended by the ECDIS manufacturer						

Checklist for the creation of a response plan for a networked ECDIS

Action	Assignee			Signed	Approved	Date last issued
	System Integrator	Ship Company	Vessel			
Create an inventory of the hardware, software networks and connections of the vessels systems to expose any vulnerabilities.						
Change network passwords/ authentication credentials on board every month or if compromised						
Ensure your Shipping Company or system integrator installs firewalls and virus checking software on board across the networks						
Ensure your Shipping Company or System Integrator checks software is kept up to date with the latest software releases						
Ensure your Shipping Company or System Integrator installs networks that are segmented, and air gaped where possible from one another						
Ensure your Shipping Company or system integrator has the vessels ECDIS only connected to external networks via a 460-Gateay or 460 Wireless Gateway and is utilising DMZs in front of your ECDIS network to minimise threat vector						
Ensure your Shipping Company or system integrator has configured your network so all other systems running on the same ECDIS network are connected via 460 switches and forwarders						
Install intrusion prevention systems and monitor network traffic for abnormalities						
Ensure networks and ports are designated for certain essential activity only						
Ensure access to network ports are digitally or physically secured to certain personnel only						
Use a separate isolated network for personal use to external network (internet)						
Regularly backup network paths and configurations in a secure location						

Action	Assignee			Signed	Approved	Date last issued
	System Integrator	Ship Company	Vessel			
Whitelist allowable network paths to the ECDIS						
Ensure network connections are automatically closed after being idle for an amount of time						
If ECDIS is connected to the communication PC via a firewall, make sure the hardware is running the latest software version from your provider						

Section 9 ECDIS Training

See also Appendix 3 of IMO MSC.1/Circ.1503 (as amended) ECDIS – Guidance for Good Practice.

ECDIS is far more than the image of a chart displayed on an electronic screen. ECDIS is a highly sophisticated system which, besides the navigational functions, includes components of a complex, computer-based information system. In total, the system includes hardware, operating system, ECDIS software (kernel and user interface), sensor input interfacing, electronic chart data, rules for presentation and display, status and parameters of alarms and indications, etc. All these items are accessed through an appropriate human machine interface. As such, care must be taken when navigating with ECDIS to avoid:

- Incorrect operation;
- Misinterpretation;
- Malfunction; or, even worse,
- Over-reliance on this highly-automated navigation system.

With any type of shipboard navigation equipment, it can only be as good as those who use it and what it is being used for. In the case of ECDIS and ENC's, if the mariner is well trained then the system will provide the relevant information that the mariner needs to make good decisions and thereby contributes significantly to safe and efficient navigation. Stated another way, an ECDIS is another tool to enable mariners to perform their job better. However, just having some "knowledge" about "functions" and "operational controls" is insufficient to maximise the benefits of ECDIS; proper training is absolutely necessary.

The overall objective of ECDIS training is to enhance navigation safety. In rather general terms, this includes:

- Safe operation of the ECDIS equipment
- Use of the functions for route planning and monitoring
- Proper action in case of any malfunction
- Proper use of ECDIS-related information
- Selection, display, and interpretation of relevant information
- Ambiguities of data management (such as "datum")
- Assessment of ENC data quality indicators (for example CATZOC)
- Assessment of alarms and indications – Awareness of ECDIS-related limitations
- Errors of displayed data and their interpretation
- Real and potential limitations
- Over-reliance on ECDIS – Knowledge of legal aspects and responsibilities related to electronic charts
- Awareness of the status of ECDIS and ECS; of official and non-official data
- Limitations of RCDS mode

In order to achieve these objectives, the mariner must acquire a thorough knowledge and functional understanding of the basic principles governing ENC data, its proper display in ECDIS and its use with navigation sensors and their respective limits. For example, the Mariner must be familiar with the object attribute structure and the feature-space relationship of ENC data as well as charted information; and the impact of such things as "SCAMIN", "overscale", "update history", "CATZOC", "safety values" and "chart usage".

ECDIS training must have an appropriate depth in theoretical aspects (ECDIS data and their presentation) as well as dealing with the proper use of ECDIS (functions and limitations). It should cover all safety-relevant aspects and go far beyond type-specific "button pressing" or basic operations. ECDIS training should be both generic and type-specific.

Ideally, training should cover the full extent of functions and procedures necessary to deal with a wide range of possible navigational problems. It should cover thorough route planning and both visual and automatic route monitoring in typical navigational situations and sea areas. To prepare a user for practical operations, decision-making and alarm handling, real-time complex ECDIS simulator exercises should be conducted.

See Appendix 3 'GUIDANCE ON TRAINING AND ASSESSMENT IN THE OPERATIONAL USE OF ECDIS SIMULATORS' IMO MSC.1/Circ.1503 (as amended) ECDIS – Guidance for Good Practice, for details.

9.1 IMO ECDIS training requirements

The IMO Committee on Standards for Training and Watch-keeping (STW) approved a standardised IMO "Model Training Course on the Operational Use of ECDIS" (Model Course 1.27). The primary objective of the Model Course is to ensure proper use and operation of ECDIS in terms of a thorough understanding and appreciation of its capabilities and limitations. The IMO Model Course contains four main parts:

- Part A: Course framework;
- Part B: Course outline and time table;
- Part C: Detailed teaching syllabus;
- Part D: Instructor manual; and
- Part E: Evaluation and assessment.

There are also annexes dealing with proposals and examples of situations for the development of scenarios and of "errors of interpretation".

In May 2012 (at the 43rd Standards of Training, Certification and Watch-keeping (STCW) meeting), the Model Course was revised and updated (annex to STW 43/3/1) in order to make provision for the generic use of ECDIS in addition to type-specific ("familiarization") training.

The contents (syllabus) of ECDIS training are listed below. They are based on the analysis of onboard navigational activities and include learning objectives at the operational as well as the management level (for example STCW Convention). In addition to providing specific learning objectives and detailed guidance on a range of subject areas, the Model Course also contains recommendations for facility and staffing requirements, entry standards, lesson plans, teaching aids, examples of ship-simulator training exercises that can be conducted, and certificates.

- Legal aspects and requirements
- Main types of electronic charts and their differences
- ECDIS data – Presentation of data
- Sensors – Basic navigational functions
- Special functions for route planning
- Special functions for route monitoring – Updating
- Additional navigational functions and indications
- Errors in displayed data – Errors of interpretation
- Status information, warnings and alarms
- Voyage documentation
- System integrity monitoring
- ECDIS back-up
- Risks of over-reliance on ECDIS

Upon completing the above course, a certificate should be issued. The certificate should document that:

- The candidate has completed a course in the operational use of ECDIS (Electronic Chart Display and Information Systems), based upon the IMO Model Course 1.27 - The Operational Use of Electronic chart Display and Information systems (ECDIS).
- The course fulfils the requirements of IMO STCW-95. The certificate should be issued by a government authority or a relevant body that is government approved.

9.2 STCW.7/Circ.24 6 February 2017

Training requirements for Electronic Chart Display and Information Systems (ECDIS) and provision of the documentation for verification

The STCW Code contains requirements for approved training on ECDIS. The certificate and endorsements are evidence of having successfully completed the required approved training and that the standard of competence has been achieved.

No requirement exists for the approved training on ECDIS equipment to be type-specific. The knowledge, understanding and proficiency required to be demonstrated is generalized to ensure seafarers have the necessary skills for basic operation of all types of equipment.

In accordance with regulation I/14, companies are responsible for ensuring that seafarers employed on their ships are familiarized with the installed equipment, including ECDIS.

It is agreed that seafarers required to have training in the use of ECDIS:

1. should not be required to provide documentation of training in ECDIS that is specific to the installed equipment;
2. and are required to be familiarized with the ECDIS equipment installed on board.

Section 10 Training Objectives

The overall objective of ECDIS training is to enhance navigation safety. In rather general terms, this includes

- Safe operation of the ECDIS equipment
 - o Use of the functions for route planning and monitoring
 - o Proper action in case of any malfunction
- Proper use of ECDIS-related information
 - o Selection, display, and interpretation of relevant information
 - o Ambiguities of data management (such as “datum”)
 - o Assessment of ENC data quality indicators (for example CATZOC)
 - o Assessment of alarms and indications
- Awareness of ECDIS-related limitations
 - o Errors of displayed data and their interpretation
 - o Real and potential limitations
 - o Over-reliance on ECDIS
- Knowledge of legal aspects and responsibilities related to electronic charts
 - o Awareness of the status of ECDIS and ECS; of official and non-official data
 - o Limitations of RCDS mode

In order to achieve these objectives, the mariner must acquire a thorough knowledge and functional understanding of the basic principles governing ENC data, its proper display in ECDIS and its use with navigation sensors and their respective limits. For example, the Mariner must be familiar with the object-attribute structure and the feature-space relationship of ENC data as well as charted information; and the impact of such things as “SCAMIN”, “overscale”, “update history”, “CATZOC”, “safety values” and “chart usage”.

ECDIS training must have an appropriate depth in theoretical aspects (ECDIS data and their presentation) as well as dealing with the proper use of ECDIS (functions and limitations). It should cover all safety-relevant aspects and go far beyond type-specific “button pressing” or basic operations. ECDIS training should be both generic and type-specific.

Ideally, training should cover the full extent of functions and procedures necessary to deal with a wide range of possible navigational problems. It should cover thorough route planning and both visual and automatic route monitoring in typical navigational situations and sea areas. To prepare a user for practical operations, decision-making and alarm handling, real-time complex ECDIS simulator exercises should be conducted.

Section 11 IMO Model Training Course - *Operational Use of ECDIS*

The IMO Committee on Standards for Training and Watch-keeping (STW) approved a standardised IMO “Model Training Course on the Operational Use of ECDIS” (Model Course 1.27). The primary objective of the Model Course is to ensure proper use and operation of ECDIS in terms of a thorough understanding and appreciation of its capabilities and limitations. The IMO Model Course contains four main parts:

- Part A: Course framework;
- Part B: Course outline and time table;
- Part C: Detailed teaching syllabus;
- Part D: Instructor manual; and
- Part E: Evaluation and assessment.

There are also annexes dealing with proposals and examples of situations for the development of scenarios and of “errors of interpretation”.

In May 2012 (at the 43rd Standards of Training, Certification and Watch-keeping (STCW) meeting), the Model Course was revised and updated (annex to STW 43/3/1) in order to make provision for the generic use of ECDIS in addition to type-specific (“familiarization”) training.

The contents (syllabus) of ECDIS training are listed below. They are based on the analysis of onboard navigational activities and include learning objectives at the operational as well as the management level (for example STCW Convention). In addition to providing specific learning objectives and detailed guidance on a range of subject areas, the Model Course also contains recommendations for facility and staffing requirements, entry standards, lesson plans, teaching aids, examples of ship-simulator training exercises that can be conducted, and certificates.

- Legal aspects and requirements
- Main types of electronic charts and their differences
- ECDIS data
- Presentation of data
- Sensors
- Basic navigational functions
- Special functions for route planning
- Special functions for route monitoring
- Updating
- Additional navigational functions and indications
- Errors in displayed data
- Errors of interpretation
- Status information, warnings and alarms
- Voyage documentation
- System integrity monitoring
- ECDIS back-up
- Risks of over-reliance on ECDIS

Section 12 Certification of ECDIS Education

The certificate should document that:

- The candidate has completed a course in the operational use of ECDIS (Electronic Chart Display and Information Systems), based upon the IMO Model Course 1.27 - *The Operational Use of Electronic chart Display and Information systems (ECDIS)*.
- The course fulfils the requirements of IMO STCW-95.

The certificate should be issued by a government authority or a relevant body that is government approved.

ANNEX A: Zones of Confidence Categories

Table A-1 – Zones of Confidence categories

ZOC Category (note 1)	Position Accuracy (note 2)	Depth Accuracy (note 3)		Seafloor Coverage	Typical Survey Characteristics (note 5)
A1	± 5 m + 5% depth	= 0.50 + 1% <i>d</i>		Full area search undertaken. Significant seafloor features detected (note 4) and depths measured.	Controlled, systematic survey (note 6) high position and depth accuracy achieved using DGPS and a multi-beam, channel or mechanical sweep system.
		Depth (m)	Accuracy (m)		
		10	± 0.6		
		30	± 0.8		
		100	± 1.5		
		1000	± 10.5		
A2	± 20 m	= 1.00 + 2% <i>d</i>		Full area search undertaken. Significant seafloor features detected (note 4) and depths measured.	Controlled, systematic survey (note 6) achieving position and depth accuracy less than ZOC A1 and using a modern survey echo-sounder (note 7) and a sonar or mechanical sweep system.
		Depth (m)	Accuracy (m)		
		10	± 1.2		
		30	± 1.6		
		100	± 3.0		
		1000	± 21.0		
B	± 50 m	= 1.00 + 2% <i>d</i>		Full area search not achieved; uncharted features, hazardous to surface navigation are not expected but may exist.	Controlled, systematic survey (note 6) achieving similar depth but lesser position accuracies than ZOC A2, using a modern survey echo-sounder (note 7), but no sonar or mechanical sweep system.
		Depth (m)	Accuracy (m)		
		10	± 1.2		
		30	± 1.6		
		100	± 3.0		
		1000	± 21.0		
C	± 500 m	= 2.00 + 5% <i>d</i>		Full area search not achieved, depth anomalies may be expected.	Low accuracy survey or data collected on an opportunity basis such as soundings on passage.
		Depth (m)	Accuracy (m)		
		10	± 2.5		
		30	± 3.5		
		100	± 7.0		
		1000	± 52.0		
D	Worse than ZOC C	Worse than ZOC C		Full area search not achieved, large depth anomalies may be expected.	Poor quality data or data that cannot be quality assessed due to lack of information.
U	Unassessed - The quality of the bathymetric data has yet to be assessed				
Column: 1	2	3		4	5

Source: IHO S-57 Ed3.1 Supp 3 (Jun 2014), pp 13-14

Remarks:

To decide on a ZOC Category, all conditions outlined in columns 2 to 4 of the table must be met.

Explanatory notes quoted in table A-1:

Note 1. The allocation of a ZOC indicates that particular data meets minimum criteria for position and depth accuracy and seafloor coverage defined in table A-1. ZOC categories reflect a charting standard and not just a hydrographic survey standard. Depth and position accuracies specified for each ZOC category refer to the errors of the final depicted soundings and include not only survey errors but also other errors introduced in the chart production process.

Note 2. Position accuracy of depicted soundings at 95% CI (2.45 sigma) with respect to the given datum. It is the cumulative error and includes survey, transformation and digitizing errors etc. Position accuracy need not be rigorously computed for ZOCs B, C and D but may be estimated based on type of equipment, calibration regime, historical accuracy etc.

Note 3. Depth accuracy of depicted soundings = $a + (b*d)/100$ at 95% CI (2.00 sigma), where d = depth in metres at the critical depth. Depth accuracy need not be rigorously computed for ZOCs B, C and D but may be estimated based on type of equipment, calibration regime, historical accuracy etc.

Note 4. Significant seafloor features are defined as those rising above depicted depths by more than:

Depth Significant Feature

a. <40m: 2 m

b. >40m: 10% depth

A full seafloor search indicates that a systematic survey was conducted using detection systems, depth measurement systems, procedures, and trained personnel designed to detect and measure depths on significant seafloor features. Significant features are included on the chart as scale allows. It is impossible to guarantee that no significant feature could remain undetected, and significant features may have become present in the area since the time of the survey.

Note 5. Typical Survey Characteristics - These descriptions should be seen as indicative examples only.

Note 6. Controlled, systematic surveys (ZOC A1, A2 and B) - surveys comprising planned survey lines, on a geodetic datum that can be transformed to WGS 84.

Note 7. Modern survey echo-sounder - a high precision single beam depth measuring equipment, generally including all survey echo-sounders designed post 1970.

ANNEX B: Assessment of the quality of a survey into a Zone of Confidence by the Hydrographic Office

ENCs contain different kinds of data collected with different technologies. Some data may be more than 50 years old whereas other data is collected with the latest technology. Some data may be collected using a leadline from a ship, other data may be measured by satellite from space. All this data is compiled to provide an image of the seabed and objects above the seabed. Some data is collected by the Hydrographic Office; other data may come from port authorities, scientific research institutes and through private ship-owners. The Hydrographic Office has the task to evaluate the quality of the data received and decide if and how this data should be made available to update the ENC. This is generally achieved in accordance with the criteria described in Annex A.

As a general guideline, the following choices are made by the Hydrographic Office:

- Data from ports are generally assigned ZOC A1, A2 or B.
- Satellite data are assigned ZOC C.
- Laser data by plane are assigned ZOC B, sometimes A2.
- Private ship-owner data are assigned ZOC D.
- Data before 1980 are assigned ZOC B, C or D. In general, the older the data, the lower the value.

On a case-by-case basis, the Hydrographic Office may deviate from these general guidelines as they see fit, taking into account local knowledge of the area, intended shipping routes etc.

Assessment examples

Typical survey characteristics are the first considerations when making an assessment of seafloor coverage, depth accuracy and position accuracy. Next, the systematic/non-systematic nature of the survey; does the survey comprise planned survey lines on a known geodetic datum that can be accurately transformed to WGS 84? How accurate are the transformation parameters when converting an old survey (before 1980) to the WGS84 datum used in the ENC? The Hydrographic Office will generally take this into consideration and downgrade the CATZOC areas appropriately.

In this example, a single beam survey conducted in 1963 is very complete. Developments (more survey lines and crosslines) were made around the shoal areas and crosslines were conducted to see if any shoals existed between survey lines. Due to the completeness of this survey no uncharted features hazardous to surface navigation are expected. The resulting charted depth data would be given CATZOC of B. The area could not be given a CATZOC of A1 or A2 because full seafloor coverage was not achieved. The dynamics of the area could also influence the quality of the data.

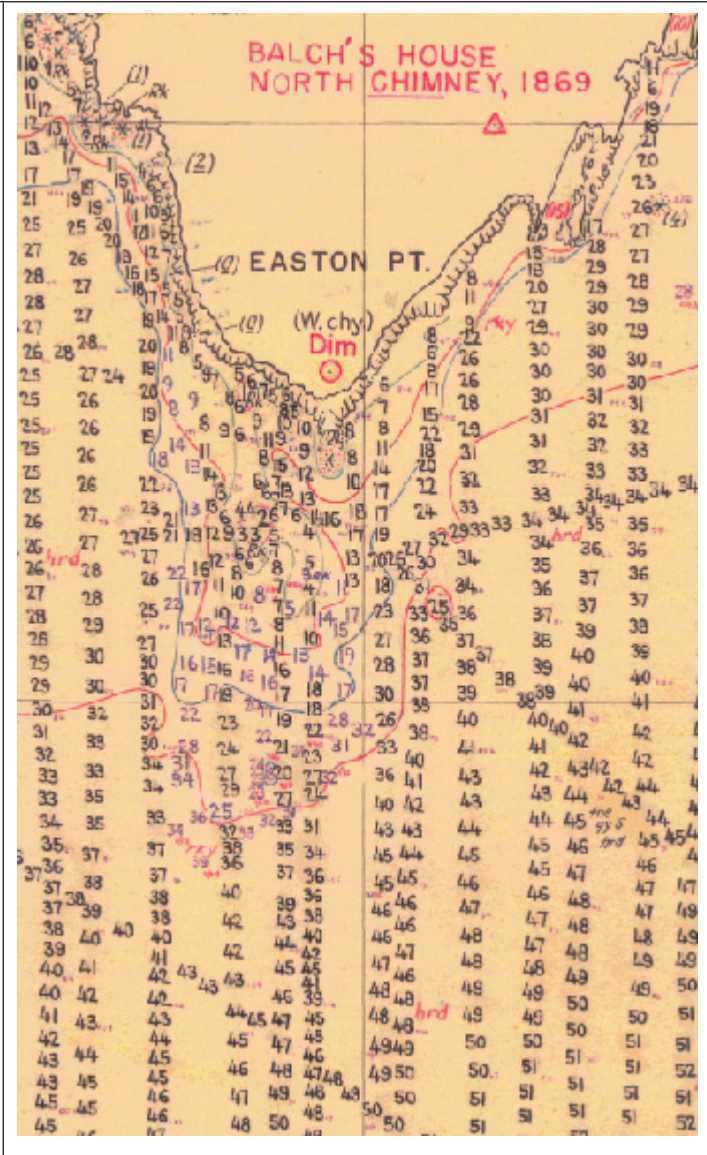

Example: Systematic single beam survey from 1963

In this example, the older hand-drawn survey was completed in 1899. It was done by leadline measurements (recorded in fathoms). These measurements are actually quite accurate. However, they are only isolated measurements, with no guarantee of finding any hazard between one leadline depth and the next. This old survey only includes hazards seen by the surveyors at or above the sea surface. It was assessed as ZOC C – depth anomalies may be expected.*

In contrast, depths taken from the modern metric survey shows a significant 2.1 metre shoal not found during the original survey. It proves that the 1899 survey, if it was the only survey in this area, could not be trusted; and that precautions should be taken.

NOTE: *The CATZOC value shown on the ENC would be based on the value assigned to the modern metric survey, however soundings from both surveys may be used.*

(1 fathom equals 1.8 metres.)*

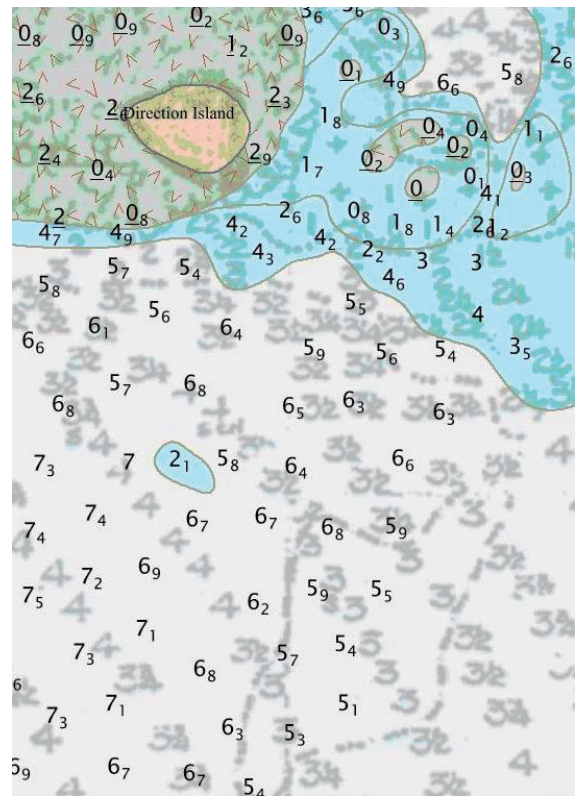

Example: Leadline survey from 1899

Position accuracy of a survey

Position accuracy of a survey is typically determined by the positioning systems used during the hydrographic survey. The ability to accurately position a ship anywhere on the globe has significantly improved over the last 100 years.

Since 1978 the US government has provided a space-based radio navigation system, operated by US Air Force. This service, the Global Positioning System (GPS), is available to an unlimited number of users with a GPS receiver. The user can determine accurate time and location, in any weather, day or night, anywhere around the globe. Other countries have provided a similar service, GLONASS (Russian); Beidou (Chinese); and Galileo (EU). A user with a Global Navigation Satellite System (GNSS) receiver can now use all these services at the same time, thus improving the horizontal and vertical accuracy of their position.

The accuracy of a GPS receiver in the 1980s was approximately 30 metres. For hydrographic surveys, a land-based correction signal was supplied to correct for errors introduced by the US Air Force for military purposes; and for signal loss between satellites and receiver. The initial accuracy of 30 metres was initially brought down to 2 metres and eventually to 0.10 metres. The accuracy for a standard GNSS receiver is nowadays in the range of 5 metres, however accuracy of positions in the Arctic can be less due to the fact that the satellites do not pass directly overhead. With the full service of Galileo, the accuracy of a standalone GNSS receiver will become 0.20 metres. This means that the position of the ship will become (far) more accurate than the surveys previously collected and charted.

From the late 1940s to the 1990s survey ships depended upon shore-based electronic positioning systems transmitting their signal over short or medium ranges, giving accuracy of around 20 to 100 metres. In coastal areas, this means that true position of an object could be up to 100 metres from where it was thought to be. Much of this depended upon how accurately the transmitter ashore was positioned, as well as the accuracy of the transmitted ranges to generate the 'fix'.

Prior to this, survey ships used sextants to measure angles between a system of prominent marks, or flag poles built on towers established ashore, with surveyors 'angling' for hours at a time. A second row of towers could be built in shallow water or on reefs to extend the network further offshore, but with a further reduction in accuracy. Depending upon how accurately the towers were placed, accuracy of 50 to 500 metres was possible for the survey ship. So again, particularly offshore, the true position of an object could quite easily be up to 500 metres from where it was thought to be.

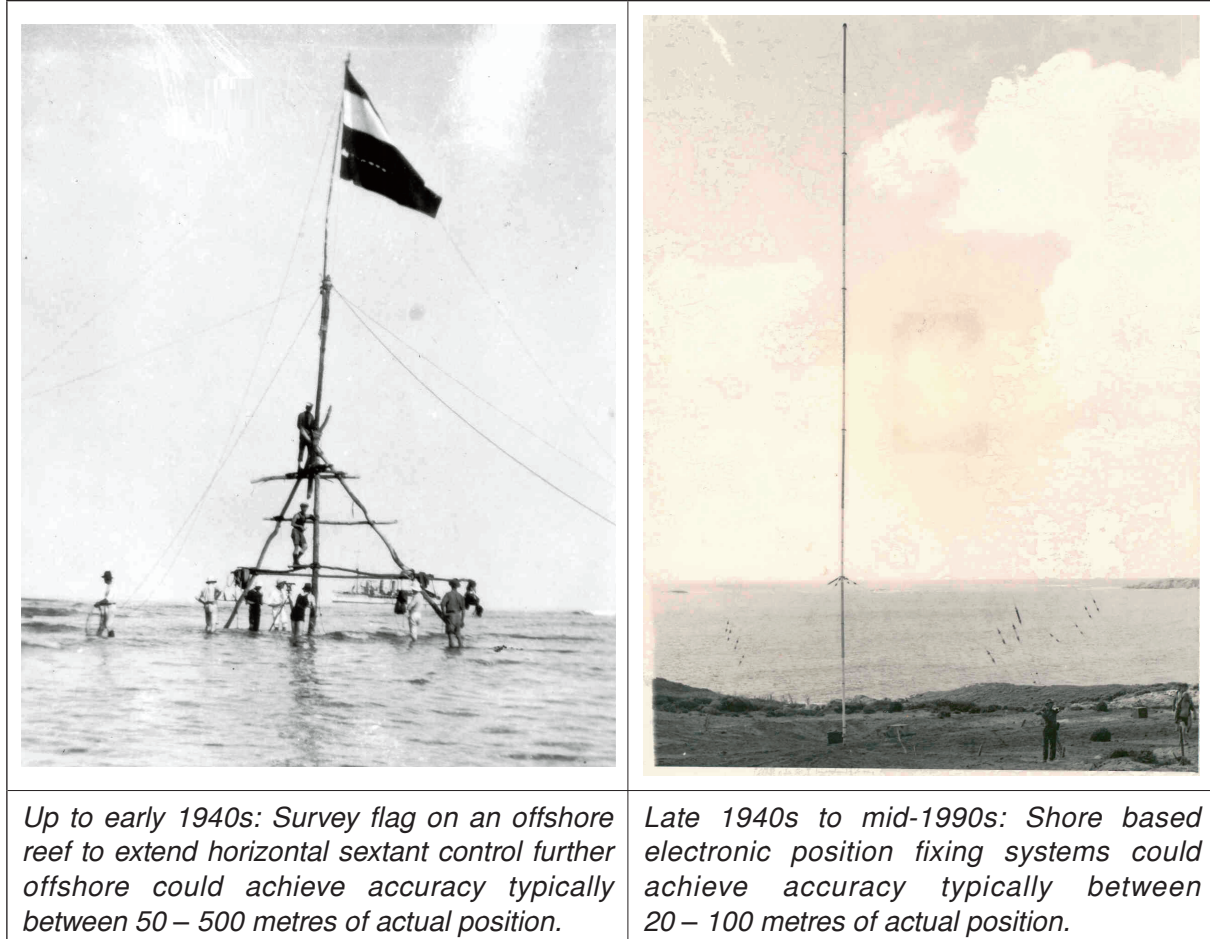

Position fixing – pre-1940s; late 1940s to 1990s

Further offshore, where information was collected by ships relying entirely upon celestial navigation, positions could be considerably less accurate, typically no better than 1 to 2NM, and frequently worse.

While modern satellite imagery can be used to correct the position of many isolated visible offshore features, such as islands, reefs or perhaps shoals breaking in rough weather, anything more than a few metres below the surface is likely to remain unseen, and therefore possibly charted well out of its true position.

ANNEX C: References and Further Reading

References

- International Convention for the Safety of Life at Sea (SOLAS)
- International Convention for Standards for Training, Certification and Watchkeeping (STCW)
- IMO Resolution MSC.232 (82): Revised Performance Standards for ECDIS
- IEC 61174: Electronic chart display and information system (ECDIS) - Operational and performance requirements, methods of testing and required test results
- IEC 62288: Maritime navigation and radiocommunication equipment and systems - Presentation of navigation-related information on shipborne navigational displays – General requirements, methods of testing and required test results
- The latest versions of the following IHO ECDIS and ENC Standards can be accessed from: www.iho.int > *ENCs & ECDIS* > [Current ENC and ECDIS Standards](#)
- IHO S-52: Specifications for Chart Content and Display Aspects of ECDIS;
- IHO S-57: IHO Transfer Standard for Digital Hydrographic Data
- Appendix B.1 – ENC Product Specification
- IHO S-61: IHO Product Specification for Raster Navigational Charts
- IHO S-62: IHO List of Data Producer Codes
- IHO S-63: IHO Data Protection Scheme.
- ENC related IHO S-100 based Specification under development:
- IHO S-101: ENC Product Specification

For information on the latest versions of documents mentioned above, consult the web site of the issuing Organization:

International Maritime Organization	www.imo.org
International Hydrographic Organization	www.iho.int
International Electrotechnical Commission	http://www.iec.ch

- Links to the following IMO Circulars may be found on the IHO web site http://iho.int/iho_pubs/IHO_Download.htm, under the table entry for S-66, as supplementary reference documents to S-66:
- IMO MSC.1/Circ.1503 (as amended) *ECDIS – Guidance for Good Practice*;
- IMO STCW.7/Circ.24 (as amended) *INTERNATIONAL CONVENTION ON STANDARDS OF TRAINING, CERTIFICATION AND WATCHKEEPING FOR SEAFARERS (STCW), 1978, AS AMENDED - Guidance for Parties, Administrations, Port State control authorities, recognized organizations and other relevant parties on the requirements of the STCW Convention, 1978, as amended*;
- IMO SN.1/Circ.213 *Guidance on Chart Datums and the Accuracy of Positions on Charts*;
- IMO SN.1/Circ.255 *Additional Guidance on Chart Datums and the Accuracy of Positions on Charts*.

NOTES

NOTES

NOTES

NOTES